









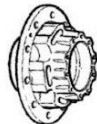

Rif. ERREVI ERREVI Ref.	DESCRIZIONE PARTICOLARI Description	TIPO Vehicle Model	RIF. ORIG. Orig. Ref.
CABINA / CABIN			
AC7107	Ammortizzatore cabina completo posteriore <i>Cabin shock absorber with air bellow, rear</i> 	ø 14 / ø 14 RENAULT Serie C-T-K Series	7421821030 7421171977
AC7106	Ammortizzatore cabina completo anteriore <i>Cabin shock absorber with air bellow, front</i> 	ø 14 / M12 RENAULT Serie C Series VOLVO FM	7421170696 21430900
PONTE POSTERIORE / REAR AXLE			
713352	Mozzo ruota con cuscinetti FAG <i>Wheel hub with FAG bearing</i>  ERREVI INDUSTRIAL 713751 Mozzo ruota nudo / <i>Wheel hub bare</i> 713302 Mozzo ruota con cuscinetti / <i>Wheel hub with bearing</i>	SCANIA 94 - 114 - 124 - 144 - 164	1382884S
AVANTRENO / FRONT AXLES			
728764	Cuscinetto mozzo (33208) <i>Hub bearing</i> 	ø 40x80x32 DAF IVECO New Daily 35.10-45.10-49.10 Turbo Daily 35.12-45.12-49.12 MAN MERCEDES RENAULT SCANIA VOLVO	0738458 1197998 1602391 1652127 8582739 1905261 06324890002 06324890043 81934200077 81934200205 0039813905 0039817205 0049816805 0069816205 0089810105 0089817505 3849817605 5000546524 5001830654 5010136762 5010439056 5010534037 284843 184679 3094303





I marchi ed i nominativi dei costruttori come pure i riferimenti originali sono esposti a solo titolo indicativo in quanto i nostri particolari non sono originali
Manufacturer's names and part numbers in this catalogue are used for cross reference purposes only and do not imply anything about the origin or manufacturer of product.

Rif. ERREVI ERREVI Ref.	DESCRIZIONE PARTICOLARI Description	TIPO Vehicle Model	RIF. ORIG. Orig. Ref.
Segue AVANTRENO / <i>Cont.d</i> FRONT AXLES			
728765	Cuscinetto mozzo (33206) Hub bearing 	ø 30x62x25 IVECO New Daily 35.10-45.10-49.10 Turbo Daily 35.12-45.12-49.12 MAN MERCEDES RENAULT SCANIA VOLVO	8582740 503473270 06324990065 06324990175 06324990176 0029819105 0029819905 0109811505 5010439054 315288 183728
728766	Cuscinetto mozzo (BTH1227) Hub bearing 	ø 40x73x55 IVECO Daily 2000 65C11/C13/C15 Daily 2006 35C12 - 50C18	504288649 503642698 93825736
S11184	Complessivo revisione perni fusi (1 RUOTA) King pin repair kit (Services 1 WHEEL) 	ø 52/53x235 MAN TGA - TGM - TGS - TGX	81442056038
728763	Cuscinetto esterno mozzo (32312) Hub bearing, outer 	ø 60x130x48,5 MERCEDES ACTROS ACTROS MP2 - ACTROS MP3 ACTROS MP4 - ACTROS MP5 ATEGO - AXOR - AXOR 2	0119816805 0119816905 0159817505
STERZO / STEERING			
713258	Testa completa S. (barra accoppiamento) Tie-rod end LH (track rod) 	M28x1,5 - M20x1,5 DAF LF-LF45	1604247 1703473 1705908 1902996
713259	Testa completa D. (barra accoppiamento) Ball Joint 	M28x1,5 - M20x1,5 DAF LF-LF45	1604248 1703472 1705907 1902997



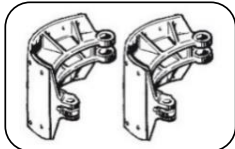

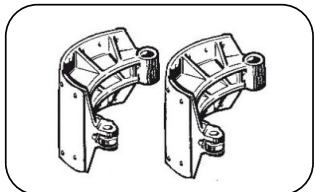

I marchi ed i nominativi dei costruttori come pure i riferimenti originali sono esposti a solo titolo indicativo in quanto i nostri particolari non sono originali
Manufacturer's names and part numbers in this catalogue are used for cross reference purposes only and do not imply anything about the origin or manufacturer of product.

Rif. ERREVI ERREVI Ref.	DESCRIZIONE PARTICOLARI Description	TIPO Vehicle Model	RIF. ORIG. Orig. Ref.
Segue STERZO / <i>Cont.d</i> STEERING			
713280	Testa completa D. (barra accoppiamento) <i>Tie-rod end RH (track rod)</i> 	M30x1,5 - M20x1,5 DAF Serie F series IVECO MAN MERCEDES Serie L-NG-O-OF-SK series RENAULT	0069867 0161376 0608000 1142173 1326866 2980875 81953010025 81953016151 90804154117 0004600148 0004602648 0004602748 0014607448 5000808458 7701002911
713282	Testa completa D. (barra accoppiamento) <i>Tie-rod end RH (track rod)</i> 	M30x1,5 - M18x1,5 MERCEDES Serie L-NG-O-OF series	0003303135 0003308135 0013300335 0013300435
713284	Testa completa S. <i>Tie-rod end LH</i> 	M35x1,5 - M20x1,5 MERCEDES O 305-O 307-O 500 Serie SK series	0003301935 0003302935 0003304135 0003307835 0003385029 0013302235 0013302735 0013303135
713285	Testa completa D. <i>Tie-rod end RH</i> 	M32x1,5 - M24x1,5 MERCEDES O-OF-OH RENAULT Kerax2-Magnum2 VOLVO	0014607248 5001866165 5001867774 7421566080 7422077102 21566080
FRENI / BRAKES			
730573	Cuffia parapolvere <i>Rubber boot</i> 	ASTRA HD8 - HD9 IVECO Eurotrakker Eurotrakker Cursor	42536176 42536176
718689	Ganascia freno completa di rullo senza ceppi <i>Brake shoe c/w roller, unlined</i> 	mm 200 DAF 65CF - 75CF - 85CF - 95FA CF65 - CF75 - CF85 - LF55 - XF105	1246532 391156

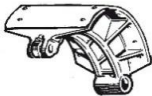

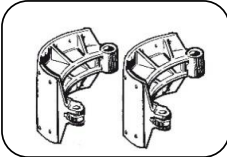

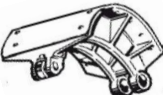

I marchi ed i nominativi dei costruttori come pure i riferimenti originali sono esposti a solo titolo indicativo in quanto i nostri particolari non sono originali
Manufacturer's names and part numbers in this catalogue are used for cross reference purposes only and do not imply anything about the origin or manufacturer of product.

Rif. ERREVI ERREVI Ref.	DESCRIZIONE PARTICOLARI Description	TIPO Vehicle Model	RIF. ORIG. Orig. Ref.
Segue FRENI / <i>Cont.d</i> BRAKES			
750004 718689 K90910 	Serie ganasce con ceppi STD - 1 Ruota <i>Brake shoe c/w STD linings - Services 1 wheel</i> Composto da / <i>Complete with</i> Ganascia / <i>Brake shoe</i> Serie ceppi freno / <i>Brake lining set</i> 	mm. 200 DAF 65CF - 75CF - 85CF - 95FA CF65 - CF75 - CF85 - LF55 - XF105	1246532S 391156S
PF9331	Serie pastiglie freno con kit <i>Brake pad set c/w kit</i> Impianto frenante tipo KNORR / <i>KNORR brake system</i> 	248x109,5x30 MAN TGA - TGM MERCEDES ACTROS - ATEGO - AXOR SCANIA Serie P - G - R - T Series	81508205099 29331 0004211810 0004236610 00024207020 00034201020 29331 2271804 2325212 2325213 1527633 1521979 1890861 29331
718690	Ganascia freno completa di rullo senza ceppi <i>Brake shoe c/w roller, unlined</i> 	mm 220 MAN E2000 - F2000 - F90 - M2000 TGA - TGS - TGX MERCEDES ACTROS ACTROS MP2/MP3 ATEGO AXOR - AXOR 2	81502006504 81502010107 81502016114 81502016185 81502016218 81502016221 81502016223 3504200219 6204200119 6204200319 9204200519 6244200019 6244200219 6524200019 6594200419 6594200519
750001 718690 K11960 	Serie ganasce con ceppi STD - 1 Ruota <i>Brake shoe c/w STD linings - Services 1 wheel</i> Composto da / <i>Complete with</i> Ganascia / <i>Brake shoe</i> Serie ceppi freno / <i>Brake lining set</i> 	mm. 220 MAN E2000 - F2000 - F90 - M2000 TGA - TGS - TGX MERCEDES ACTROS ACTROS MP2/MP3 ATEGO AXOR - AXOR 2	81502006504S 81502010107S 81502016114S 81502016185S 81502016218S 81502016221S 81502016223S 3504200219S 6204200119S 6204200319S 9204200519S 6244200019S 6244200219S 6524200019S 6594200419S 6594200519S



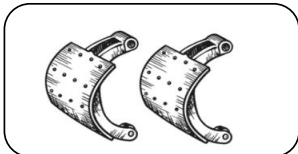

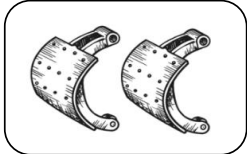

I marchi ed i nominativi dei costruttori come pure i riferimenti originali sono esposti a solo titolo indicativo in quanto i nostri particolari non sono originali
 Manufacturer's names and part numbers in this catalogue are used for cross reference purposes only and do not imply anything about the origin or manufacturer of product.

Rif. ERREVI ERREVI Ref.	DESCRIZIONE PARTICOLARI Description	TIPO Vehicle Model	RIF. ORIG. Orig. Ref.
Segue FRENI / <i>Cont.d</i> BRAKES			
718691	Ganascia freno completa di rullo senza ceppi <i>Brake shoe c/w roller, unlined</i> 	mm 180 MAN E2000 - F2000 - F90 - M90 - M2000 TGA - TGM - TGS - TGX MERCEDES ACTROS ACTROS MP2/MP3 ATEGO AXOR - AXOR 2	81502016086 81502016099 81502016184 81502016220 3894206119 3894206419 6594200619
750002 718691 K11980 	Serie ganasce con ceppi STD - 1 Ruota <i>Brake shoe c/w STD linings - Services 1 wheel</i> Composto da / <i>Complete with</i> Ganascia / <i>Brake shoe</i> Serie ceppi freno / <i>Brake lining set</i> 	mm. 180 MAN E2000 - F2000 - F90 - M90 - M2000 TGA - TGM - TGS - TGX MERCEDES ACTROS ACTROS MP2/MP3 ATEGO	81502016086S 81502016099S 81502016184S 81502016220S 3894206119S 3894206419S 6594200619S
718696	Ganascia freno posteriore nuda <i>Brake shoe rear, unlined</i> 	mm. 225 RENAULT Kerax Magnum AE Premium	5010098948
718697	Ganascia freno posteriore nuda <i>Brake shoe rear, unlined</i> 	mm. 225 RENAULT Kerax Premium	5010525775
PF9332	Serie pastiglie freno con kit <i>Brake pad set c/w kit</i> Impianto frenante tipo KNORR / <i>KNORR brake system</i> 	249,5x106,75x29 SCANIA Serie P - G - R - T Series	2272503 2272502 2127745 29332









I marchi ed i nominativi dei costruttori come pure i riferimenti originali sono esposti a solo titolo indicativo in quanto i nostri particolari non sono originali
Manufacturer's names and part numbers in this catalogue are used for cross reference purposes only and do not imply anything about the origin or manufacturer of product.

Rif. ERREVI ERREVI Ref.	DESCRIZIONE PARTICOLARI Description	TIPO Vehicle Model	RIF. ORIG. Orig. Ref.
Segue FRENI / <i>Cont.d</i> BRAKES			
718692	Ganascia freno completa di rullo senza ceppi <i>Brake shoe c/w roller, unlined</i> 	178 mm SCANIA 93 - 113 - 143 94 - 114 - 124 - 144 - 164 Serie P - G - R - T Series	1104543 1104547
750007 718692 K11310 	Serie ganasce con ceppi STD - 1 Ruota <i>Brake shoe c/w STD linings - Services 1 wheel</i> Composto da / <i>Complete with</i> Ganascia / <i>Brake shoe</i> Serie ceppi freno / <i>Brake lining set</i> 	mm. 178 SCANIA 93 - 113 - 143 94 - 114 - 124 - 144 - 164 Serie P - G - R - T Series	1104543S 1104547S
718693	Ganascia freno completa di rullo senza ceppi <i>Brake shoe c/w roller, unlined</i> 	127 mm SCANIA 93 - 113 - 143 94 - 114 - 124 - 144 - 164 Serie P - G - R - T Series	1104542 1104546
750008 718693 K79910 	Serie ganasce con ceppi STD - 1 Ruota <i>Brake shoe c/w STD linings - Services 1 wheel</i> Composto da / <i>Complete with</i> Ganascia / <i>Brake shoe</i> Serie ceppi freno / <i>Brake lining set</i> 	mm. 127 SCANIA 93 - 113 - 143 94 - 114 - 124 - 144 - 164 Serie P - G - R - T Series	1104542S 1104546S
750074	Kit revisione freni Sx <i>Brake adjuster repair kit. Left</i> 	VOLVO F10-F12-F16-FL7-FL10	272906
750075	Kit revisione freni Dx <i>Brake adjuster repair kit, right</i> 	VOLVO F10-F12-F16-FL7-FL10	272907





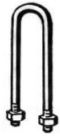

I marchi ed i nominativi dei costruttori come pure i riferimenti originali sono esposti a solo titolo indicativo in quanto i nostri particolari non sono originali
Manufacturer's names and part numbers in this catalogue are used for cross reference purposes only and do not imply anything about the origin or manufacturer of product.

Rif. ERREVI ERREVI Ref.	DESCRIZIONE PARTICOLARI Description	TIPO Vehicle Model	RIF. ORIG. Orig. Ref.
Segue FRENI / <i>Cont.d</i> BRAKES			
750079	Kit revisione freni Dx <i>Brake adjuster repair kit, RH</i> 	VOLVO FH12 - FH16 - FM9 - FM12 F12-F16-FL	1696925S 8550977S
750080	Kit revisione freni Sx <i>Brake adjuster repair kit, LH</i> 	VOLVO FH12 - FH16 - FM9 - FM12 F12-F16-FL	1696924S 8550978S
SOSPENSIONE / SUSPENSION			
720236	Perno balestra <i>Spring pin</i>  Collegati / <i>Connected</i> 729647 Dado / <i>Nut</i>	ø 16x120 ASTRA HD9 IVECO Eurocargo - Eurocargo "Tector" 100E ... - 110E... - E120... - 120E... - 140E... 150E ... Eurotech - Eurostar Stralis - Trakker	16683835 16683834 16683835 16683834
720244	Perno balestra <i>Spring pin</i>  Collegati / <i>Connected</i> 729649 Dado / <i>Nut</i>	ø 20x140 ASTRA HD9 IVECO Eurocargo - Eurocargo "Tector" Eurotech	16638234 98475607 16638234 98475607
720255	Perno fissaggio barra stabilizzatrice <i>Stabilizer bar pin</i>  Collegati / <i>Connected</i> 729649 Dado / <i>Nut</i>	ø 20x120 ASTRA HD9 IVECO Eurocargo - Eurocargo "Tector"	16686434 16686434
720238	Perno balestra anteriore <i>Spring pin, front</i>  Collegati / <i>Connected</i> 729861 Dado / <i>Nut</i>	ø 16x100 IVECO New Daily - Turbo Daily New Daily (96) - Turbo Daily (96) Daily CNG Daily 2006-2012 35C ...	93805748 503476419 503642524
729861	Dado autobloccante per perno balestra <i>Selflocking nut</i> 	M16x1,5 IVECO Daily 2006 - 2009 - 2014 New Daily - Turbo Daily New Daily (96) - Turbo Daily (96) Daily CNG Daily 2006-2012 35C ...	12574921 17155731





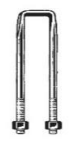

I marchi ed i nominativi dei costruttori come pure i riferimenti originali sono esposti a solo titolo indicativo in quanto i nostri particolari non sono originali
Manufacturer's names and part numbers in this catalogue are used for cross reference purposes only and do not imply anything about the origin or manufacturer of product.

Rif. ERREVI ERREVI Ref.	DESCRIZIONE PARTICOLARI Description	TIPO Vehicle Model	RIF. ORIG. Orig. Ref.
Segue SOSPENSIONE / <i>Cont.d</i> SUSPENSIONS			
720241	Perno balestra anteriore <i>Spring pin, front</i>  Collegati / <i>Connected</i> 729647 Dado / <i>Nut</i>	ø 16x160 IVECO Daily 30.8/.10 - 35.8/.10/12 40.8/.10 - 45.10 - 49.10/.12 - 59.12	16616134 42539608 42561694 5003101505 503526001
720239	Perno balestra anteriore <i>Spring pin, front</i>  Collegati / <i>Connected</i> 729861 Dado / <i>Nut</i>	ø 16x160 IVECO New Daily - Turbo Daily New Daily (96) - Turbo Daily (96) Daily CNG	93809149 503476461 503642566
720242	Perno balestra anteriore <i>Spring pin, front</i>  Collegati / <i>Connected</i> 729647 Dado / <i>Nut</i>	ø 16x170 IVECO New Daily - New Daily (96) Turbo Daily - Turbo Daily (96) Daily CNG Eurocargo - Eurocargo "Tector" 60E... - 65E... - 75E... - 80E - 100E...	16636534
720240	Perno balestra anteriore <i>Spring pin, front</i>  Collegati / <i>Connected</i> 729647 Dado / <i>Nut</i>	ø 16x85 IVECO Daily 2006 - 2009 - 2014 35C... - 35S...	500317413
720237	Perno balestra posteriore <i>Spring pin, rear</i>  Collegati / <i>Connected</i> 729647 Dado / <i>Nut</i>	ø 16x120 IVECO Daily 2006-2009-2012 29L ... - 33S... - 35S ... Eurocargo - Eurocargo "Tector" Eurotrakker - Eurotrakker "Cursor" Eurotech "Cursor" - Eurostar "Cursor" Stralis	16635634 98475606
720235	Perno balestra posteriore <i>Spring pin, rear</i>  Collegati / <i>Connected</i> 729647 Dado / <i>Nut</i>	ø 16x130 IVECO Daily 2006-2009-2012-2015-2019 29L ... - 35S ... Eurocargo 60E ... - 65E ... - 75E ... - 80E ... 100E ... - 140E... - E150... - 160E... - 180E...	16635734
722754	Staffa balestra TONDA c/dadi <i>U bolt c/w nuts</i> 	ø 12x83x170 IVECO Daily 29L12/L13/L14/L15 33S13/S14/S15/S16 35S11/S12/S13/S14/S15/S16/S17/S18	504183109
722755	Staffa balestra QUADRA c/dadi <i>U bolt c/w nuts</i> 	ø 14x80x170 IVECO Daily 29L10/L12/L14 35S9/S10/S11/S12/S13/S14/S15/S17	504095215

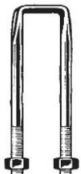

I marchi ed i nominativi dei costruttori come pure i riferimenti originali sono esposti a solo titolo indicativo in quanto i nostri particolari non sono originali
Manufacturer's names and part numbers in this catalogue are used for cross reference purposes only and do not imply anything about the origin or manufacturer of product.

Rif. ERREVI ERREVI Ref.	DESCRIZIONE PARTICOLARI Description	TIPO Vehicle Model	RIF. ORIG. Orig. Ref.
Segue SOSPENSIONE / <i>Cont.d</i> SUSPENSIONS			
722756	Staffa balestra QUADRA c/dadi <i>U bolt c/w nuts</i>  ø 14x70x100	IVECO Daily 33S11/S12/S13/S14/S15/S16 35S11/S12/S13/S14/S15/S16//S17/S18/S21	5801585565
722757	Staffa balestra QUADRA c/dadi <i>U bolt c/w nuts</i>  ø 16x60x100	IVECO Daily 35C10/C11/C12/C13/C14/C15/C16/C17/C18 50C11/C13/C15	93809304 93807059 503646883
722758	Staffa balestra QUADRA c/dadi <i>U bolt c/w nuts</i>  ø 16x60x170	IVECO Daily 35C10/C11/C12/C13/C14/C15/C16/C17/C18 40C10/C11/C12/C13/C14/C15/C16/C17/C18 50C11/C12/C13/C14/C15/C16/C17/C18/C21	93826489
722759	Staffa balestra QUADRA c/dadi <i>U bolt c/w nuts</i>  ø 16x80x140	IVECO Daily 29L10/L12/L13/L14/L15 35S10/S11/S12/S13/S14/S15/S17/S18/S21	504234647
722760	Staffa balestra QUADRA PIATTA c/dadi <i>U bolt c/w nuts</i>  ø 16x70x285	IVECO Daily 35S15/S17/S18 - 55S15/S17/S18	504330518
720260	Perno fissaggio barra stabilizzatrice <i>Stabilizer bar pin</i>  Collegati /Connected 729649 Dado / Nut	ø 27x62/100 IVECO Eurocargo - Eurocargo "Tector"	99447237 4842006
720258	Perno balestra anteriore <i>Spring pin, front</i>  Collegati /Connected 729649 Dado / Nut	ø 20x130 IVECO Eurocargo - Eurocargo "Tector"	16638134

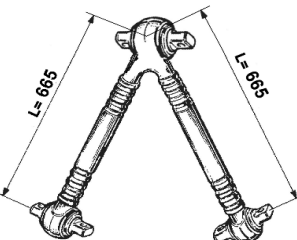
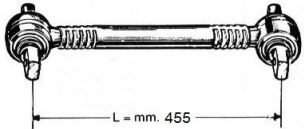

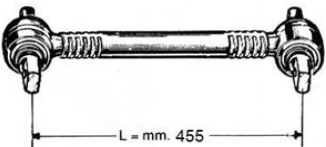
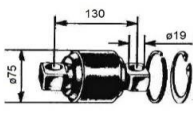
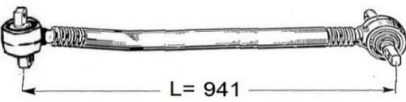
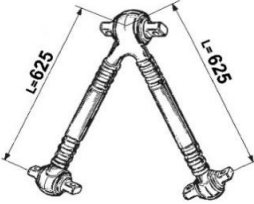

I marchi ed i nominativi dei costruttori come pure i riferimenti originali sono esposti a solo titolo indicativo in quanto i nostri particolari non sono originali
Manufacturer's names and part numbers in this catalogue are used for cross reference purposes only and do not imply anything about the origin or manufacturer of product.

Rif. ERREVI ERREVI Ref.	DESCRIZIONE PARTICOLARI Description	TIPO Vehicle Model	RIF. ORIG. Orig. Ref.
Segue SOSPENSIONE / <i>Cont.d</i> SUSPENSIONS			
722761	Staffa balestra QUADRA PIATTA c/dadi <i>U bolt c/w nuts</i> 	IVECO Eurocargo 140E18/E19/E21/E22/E24/E25/E28 150E18/E28/E30 160E18/E21/E22/E24/E25/E28/E32	504250323 98485773
720243	Perno balestra posteriore <i>Spring pin, rear</i>  Collegati / <i>Connected</i> 729649 Dado / <i>Nut</i>	IVECO Eurocargo - Eurocargo "Tector" 100E... - 110E... - 120E... - 130E... - 140E... 150E... - 170E... - 180E... - 260E - 280E... Eurotech 180E... - 190E... - 400E	98416963
720261	Perno balestra posteriore <i>Spring pin, rear</i>  Collegati / <i>Connected</i> 729649 Dado / <i>Nut</i>	IVECO Eurocargo - Eurocargo "Tector" Eurotech - Eurotech "Cursor" Eurostar "Cursor" Eurotrakker Stralis - Trakker	16686234
720256	Perno balestra posteriore <i>Spring pin, rear</i>  Collegati / <i>Connected</i> 729649 Dado / <i>Nut</i>	IVECO Eurocargo "Tector" Eurotech - Eurostar - Eurotrakker Eurotech "Cursor" - Eurostar "Cursor" Eurotrakker "Cursor" Stralis - Trakker	16686334 16686335
720259	Perno balestra posteriore <i>Spring pin, rear</i>  Collegati / <i>Connected</i> 729649 Dado / <i>Nut</i>	IVECO Eurocargo - Eurocargo "Tector" Eurotech - Eurostar Eurotech "Cursor" Stralis	16638034
720257	Perno balestra posteriore <i>Spring pin, rear</i>  Collegati / <i>Connected</i> 729649 Dado / <i>Nut</i>	IVECO Eurocargo - Eurocargo "Tector" Eurotech	98424895
712883	Barra di reazione angolare <i>Angle torque arm</i> 	IVECO Trakker Stralis	41272706 41272707
712896	Barra di reazione <i>Torque Rod</i> 	IVECO Eurostar-Eurotech-Stralis	41009961 41225960



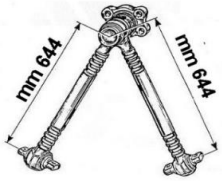
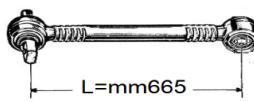
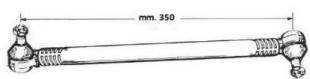

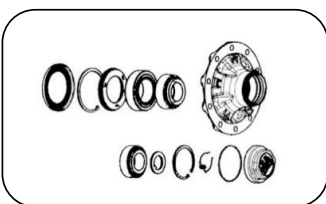
I marchi ed i nominativi dei costruttori come pure i riferimenti originali sono esposti a solo titolo indicativo in quanto i nostri particolari non sono originali
Manufacturer's names and part numbers in this catalogue are used for cross reference purposes only and do not imply anything about the origin or manufacturer of product.

Rif. ERREVI ERREVI Ref.	DESCRIZIONE PARTICOLARI Description	TIPO Vehicle Model	RIF. ORIG. Orig. Ref.
Segue SOSPENSIONE / <i>Cont.d</i> SUSPENSIONS			
712897	Barra di reazione <i>Torque rod</i>  L = mm. 455	IVECO Eurostar-Eurotech-Stralis	41033731
735003	Kit revisione barra di reazione <i>Repair Kit, Axle Rod</i>  ø75xø19/130	IVECO Eurostar-Eurotech-Stralis MAN F2000 - M2000 TGA - TGM - TGS - TGX MERCEDES Bus	500333284 42579108 85432206002 0003302011
712842	Barra di reazione <i>Torque Rod</i>  L = 941 mm	MAN TGA-TGS-TGX	81432206222 81432206260 81432206283 81432206284
712894	Barra di reazione angolare <i>Angle torque arm</i>  L = 625 mm	MERCEDES Actros MP2/MP3-Arocs-Axor2	9483502705
712843	Barra di reazione <i>Torque rod</i>  L=mm 625	RENAULT Serie C series VOLVO B6-B7 FH-FH12-FH16-FL6-FM-FM9-FM12	7422076170 20410530 20509018 20517494 21196798 20374444
712899	Barra di reazione <i>Torque rod</i>  L=mm752	SCANIA Serie 3-4 series -P-G-R-T Bus serie F-K-N series Bus	1101843 1379423 1393298 1942075



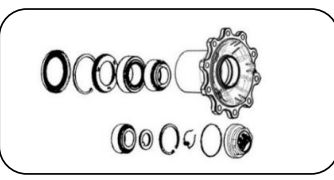

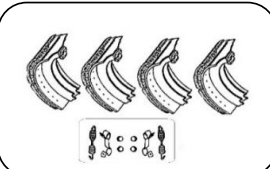
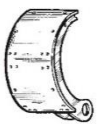

I marchi ed i nominativi dei costruttori come pure i riferimenti originali sono esposti a solo titolo indicativo in quanto i nostri particolari non sono originali
Manufacturer's names and part numbers in this catalogue are used for cross reference purposes only and do not imply anything about the origin or manufacturer of product.

Rif. ERREVI ERREVI Ref.	DESCRIZIONE PARTICOLARI Description	TIPO Vehicle Model	RIF. ORIG. Orig. Ref.
Segue SOSPENSIONE / <i>Cont.d</i> SUSPENSIONS			
712891	Barra di reazione angolare <i>Angle torque arm</i> 	L: 644 mm VOLVO F10-F12-F16-FH12-FH16-FL7-FL10-FL12 N10-N12-NL10-NL12	1590068
712840	Barra di reazione <i>Torque rod</i> 	L: 665 mm VOLVO F10-F12-F16-FL6-FL7-FL10	1082104 1605035
712884	Tirante completo barra stabilizzatrice <i>Stabilizer bar rod</i> 	L: 350 mm VOLVO FH12-FH16-FM7-FM12	3173615 3987356
ASSALI / AXLES			
PF9331	Serie pastiglie freno con kit <i>Brake pad set c/w kit</i> Impianto frenante tipo KNORR / KNORR brake system 	248x109,5x30 BPW SAF	0536270010 0980102200 29331 4057427700 29331
713379	Mozzo ruota completo (senza dado assale) <i>Wheel hub assembly (without axle nut)</i>	B.P.W. Assali 9 Ton. Serie H-SH-SKH Mozzo sistema ECO PLUS 3 <i>H-SH-SKH Series - 9 TONS types</i> <i>ECO PLUS 3 Hub system</i>	0980108390
713380	Mozzo ruota completo senza dado assale (con cuscinetti SKF) <i>Wheel hub assembly without axle nut (c/w SKF bearings)</i> 		
	713962 Mozzo ruota nudo / <i>Wheel hub bare</i>		

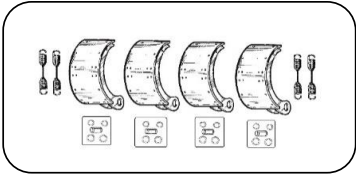
I marchi ed i nominativi dei costruttori come pure i riferimenti originali sono esposti a solo titolo indicativo in quanto i nostri particolari non sono originali
Manufacturer's names and part numbers in this catalogue are used for cross reference purposes only and do not imply anything about the origin or manufacturer of product.

Rif. ERREVI ERREVI Ref.	DESCRIZIONE PARTICOLARI Description	TIPO Vehicle Model	RIF. ORIG. Orig. Ref.
Segue ASSALI / <i>Cont.d</i> AXLES			
713381	Mozzo ruota completo (senza dado assale) <i>Wheel hub assembly (without axle nut)</i>	B.P.W. Assali tipo 9 TON Serie H-SH-SKH Mozzo sistema ECO PLUS 3 <i>9 TONS H-SH-SKH Series Axle types ECO PLUS 3 HUB SYSTEM</i>	0980108360
713382	Mozzo ruota completo senza dado assale (con cuscinetti SKF) <i>Wheel hub assembly without axle nut (c/w SKF barings)</i>		
		Assali autosterzanti tipo 8-9 TON Serie ..LL Mozzo sistema ECO PLUS 3 <i>8-9 TONS ..LL Series Self-steering axle ECO PLUS 3 HUB SYSTEM</i>	
	713338 Mozzo ruota nudo / <i>Wheel hub bare</i>		
713394	Mozzo ruota completo <i>Wheel hub assembly</i>	B.P.W. Assali 9 Ton. Serie KH-KR - 19"½ Mozzo sistema ECO MAXX <i>KH-KR Series - 9 TONS types - 19"½ ECO MAXX Hub system</i>	0980106540
713395	Mozzo ruota completo (con cuscinetti SKF) <i>Wheel hub assembly (c/w SKF barings)</i>		0980106540
			
	713336 Mozzo ruota nudo / <i>Wheel hub bare</i>		
718700	Ganascia freno completa di rullo senza ceppi <i>Brake shoe c/w roller, unlined</i>	ø 300x200 SAF Assali tipo SKRS/RZ 9030 - SKRZ 11030 <i>SKRS/RZ 9030 - SKRZ 11030 axle types</i>	3054012901
			
750009	Serie ganasce con ceppi STD ed accessori <i>Brake shoe set c/w STD linings and accessories</i>	ø 300x200 SAF Assali tipo SKRS/RZ 9030 - SKRZ 11030 <i>SKRS/RZ 9030 - SKRZ 11030 axle types</i>	3434365500
			
M50009	Serie ganasce con ceppi magg. 10/10 ed accessori <i>Brake shoe set c/w +10/10 linings and accessories</i>		
718698	Ganascia freno completa di rullo senza ceppi <i>Brake shoe c/w roller, unlined</i>	ø 420x180 SAF Assali autosterzanti tipo RLSM 9042 - RLSM 9042/20 <i>RLSM 9042 - RLSM 9042/20 Self-steering axle types (dal 1994 / 1994 on)</i>	3054005200
			

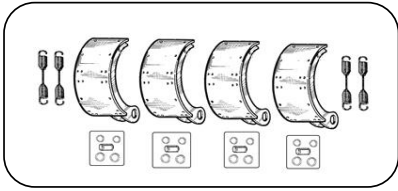
I marchi ed i nominativi dei costruttori come pure i riferimenti originali sono esposti a solo titolo indicativo in quanto i nostri particolari non sono originali
Manufacturer's names and part numbers in this catalogue are used for cross reference purposes only and do not imply anything about the origin or manufacturer of product.

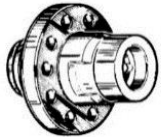
Rif. ERREVI ERREVI Ref.	DESCRIZIONE PARTICOLARI Description	TIPO Vehicle Model	RIF. ORIG. Orig. Ref.
Segue ASSALI / <i>Cont.d</i> AXLES			
750010 	Serie ganasce con ceppi STD ed accessori <i>Brake shoe set c/w STD linings and accessories</i> 	ø 420x180 SAF Assali autosterzanti tipo RLSM 9042 - RLSM 9042/20 <i>RLSM 9042 - RLSM 9042/20</i> <i>Self-steering axle types</i> (dal 1994 / 1994 on)	3054005200S
M50010	Serie ganasce con ceppi magg. 10/10 ed accessori <i>Brake shoe set c/w +10/10 linings and accessories</i>		
730813	Guarnizione per calotta <i>Gasket, Hub Cap</i> 	SAF Assali autosterzanti tipo RLSM 9042 - RLSM 9042/20 <i>RLSM 9042 - RLSM 9042/20</i> <i>Self-steering axle</i> (dal 1994 / 1994 on)	1093001200
718699	Ganascia freno completa di rullo senza ceppi <i>Brake shoe c/w roller, unlined</i> 	ø 420x200 SAF Assali autosterzanti tipo RLSM 11242 <i>RLSM 11242 Self-steering axle types</i> (dal 1992 / 1992 on)	3054005300
750011 	Serie ganasce con ceppi STD ed accessori <i>Brake shoe set c/w STD linings and accessories</i> 	ø 420x200 SAF Assali autosterzanti tipo RLSM 11242 <i>RLSM 11242 Self-steering axle types</i> (dal 1992 / 1992 on)	3054005300S
M50011	Serie ganasce con ceppi magg. 10/10 ed accessori <i>Brake shoe set c/w +10/10 linings and accessories</i>		
713327 	Mozzo ruota con cuscinetto FAG <i>Wheel hub with FAG bearing</i> 	SAF Assale tipo SKRZ 11037 <i>SKRZ 11037 axle types</i>	3307304600 3307304601
	713326 Mozzo ruota con cuscinetti / <i>Wheel hub with bearing</i>		

I marchi ed i nominativi dei costruttori come pure i riferimenti originali sono esposti a solo titolo indicativo in quanto i nostri particolari non sono originali
Manufacturer's names and part numbers in this catalogue are used for cross reference purposes only and do not imply anything about the origin or manufacturer of product.