

FRIZIONE / CLUTCH

RICAMBI PER / SPARE PARTS FOR

DAF	pag.	46 - 47
IVECO	pag.	46 - 59
MAN	pag.	58 - 59
MERCEDES	pag.	60 - 61
RENAULT	pag.	60 - 61
SCANIA	pag.	60 - 61
VOLVO	pag.	60 - 61

1

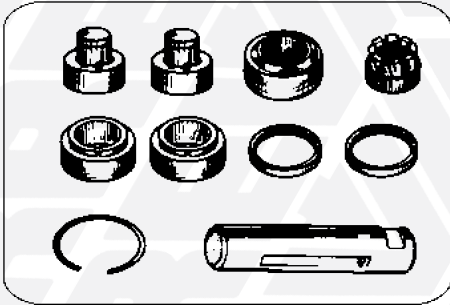

711218
1

NEW

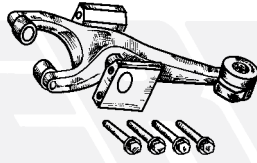

717076
2

NEW

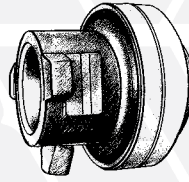

716599
3

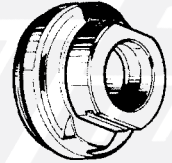

716594
4

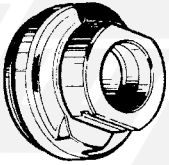

716569
5

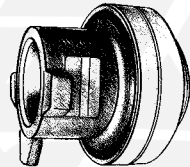

716602
6

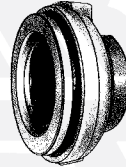

716600
7

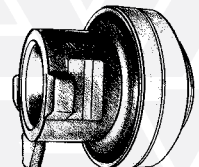

716597
8

2

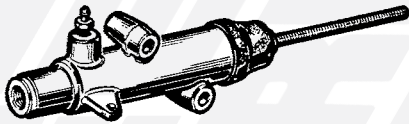

718038
9

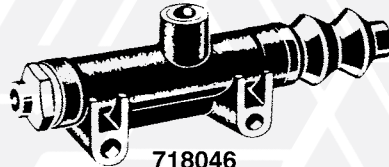

718046
10



717054
11



716587
12

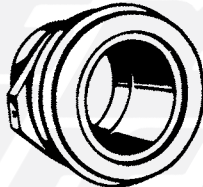

716588
13



732029
14



728529
15

3

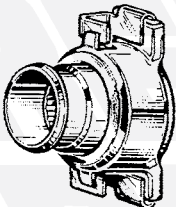

716570
16 - 20

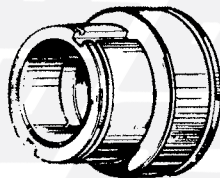

716568
17



728264
18

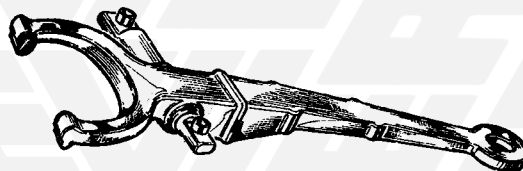

717072
19

FIG. ITEM	RIF. ERREVI ERREVI REF.	DESCRIZIONE PARTICOLARI DESCRIPTION	TIPO VEHICLE MODEL	RIF. ORIG. ORIG. REF.
<div style="display: flex; align-items: center;"> <div style="font-size: 2em; margin-right: 10px;">1</div> <div style="font-size: 2em; font-weight: bold; color: green;">DAF</div> </div>				
1	711218	Completivo revisione frizione / <i>Clutch release fork, repair kit</i>	75CF - 85CF - 95XF CF75 - CF85 - XF95	13163045 1391637S 1392537S
2	717076	Leva disinnesto frizione / <i>Withdrawal lever</i>	75CF - 85CF - 95XF CF75 - CF85 - XF95	1392537 1391637 1316304
3	716599	Manicotto distacco frizione con reggispinta / <i>Withdrawal sleeve assy</i>		1615927 1634627
4	716594	Manicotto distacco frizione con reggispinta / <i>Withdrawal sleeve assy</i>	F1100 - F1300 - F1500 - F1700 65FA	1267988 514454 659320 279810
5	716569	Manicotto distacco frizione con reggispinta / <i>Withdrawal sleeve assy</i>	75CF - 85CF - 95XF	266060 1261652
6	716602	Manicotto distacco frizione con reggispinta / <i>Withdrawal sleeve assy</i>	75CF - 85CF - 95XF CF85 - XF95	1250710 130397S 1664346
7	716600	Manicotto distacco frizione con reggispinta / <i>Withdrawal sleeve assy</i>	85CF - 95XF	1334350 1287806 1230548
8	716597	Manicotto distacco frizione con reggispinta / <i>Withdrawal sleeve assy</i>	CF85 - XF105	1746150 1697725 1822487 1830316 1686642
<div style="display: flex; align-items: center;"> <div style="font-size: 2em; margin-right: 10px;">2</div> <div style="font-size: 2em; font-weight: bold; color: green;">IVECO</div> <div style="margin-left: 10px;">616N3/4 - 50NC - 55NC</div> </div>				
9	718038	Cilindretto comando disinnesto / <i>Slave cylinder</i>		4311345 (ex 4189132)
10	718046	Cilindro maestro comando disinnesto / <i>Master cylinder</i>	50NC - 55NC	4797845 (ex 4217083)
11	717054	Leva a forcella disinnesto / <i>Withdrawal lever</i>		4605179
12	716587	Manicotto portareggispinta nudo / <i>Withdrawal sleeve</i>		-
13	716588	Manicotto portareggispinta c/cuscinetto / <i>Withdrawal sleeve assy</i>		4605181
14	732029	Molla richiamo manicotto disinnesto / <i>Sleeve spring</i>		4607761
15	728529	Reggispinta distacco (SKF 630086 A) / <i>Thrust bearing</i>	ø 50x81,7x22	4614120
<div style="display: flex; align-items: center;"> <div style="font-size: 2em; margin-right: 10px;">3</div> <div style="font-size: 2em; font-weight: bold; color: green;">NEW DAILY (30.8 - 35.8 - 40.8) TURBO DAILY (35.10 - 40.10 - 45.10 - 49.10)</div> </div>				
16	716570	Manicotto distacco frizione c/reggispinta / <i>Withdrawal sleeve assy</i>	35.10 - 40.10 - 45.10 - 49.10	2992027 (ex 1905290)
17	716568	Manicotto distacco frizione con reggispinta / <i>Withdrawal sleeve assy</i>	30.8 - 35.8 - 40.8	93800287
18	728264	Pernetto per leva disinnesto / <i>Pin</i>	30.8 - 35.8 - 40.8	93807414 (ex 93806132)
<div style="display: flex; align-items: center;"> <div style="font-size: 2em; margin-right: 10px;">3</div> <div style="font-size: 2em; font-weight: bold; color: green;">NEW DAILY ('96) (30.8 - 35.8) TURBO DAILY ('96) (30.10 - 35.10 - 35.12 - 49.10 - 49.12 - 59.12) DAILY 2000 - DAILY CNG</div> </div>				
19	717072	Leva a forcella disinnesto completa / <i>Withdrawal fork</i>		42116734
20	716570	Manicotto distacco frizione c/reggispinta / <i>Withdrawal sleeve assy</i>		2992027 (ex 1905290)

1

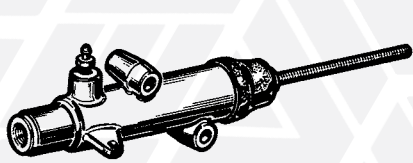

718038
1

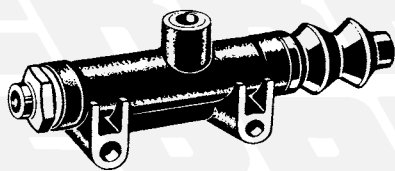

718046
2

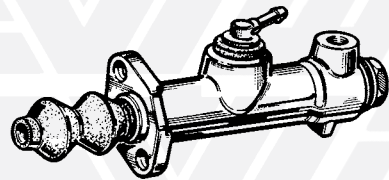

718213
3



717054
4



716587
5

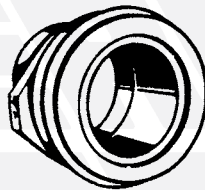

716588
6



732029
7



728529
8

2

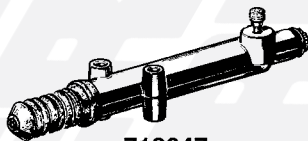

718047
9

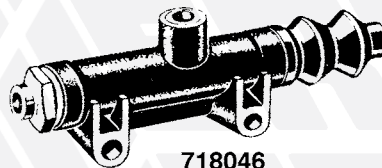

718046
10

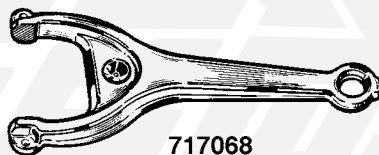

717068
11

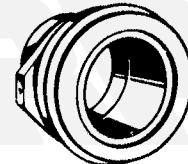

728543
12

3

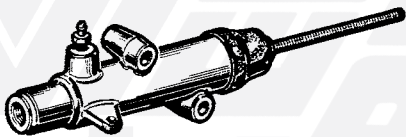

718038
13



718047
14

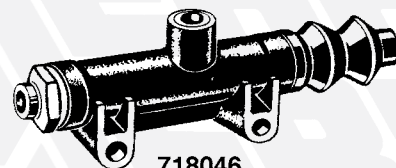

718046
15



716591
16

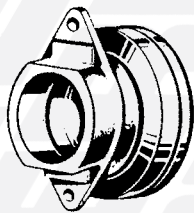

716592
17



732003
18

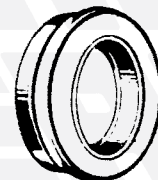

19 - 728527
20 - 728529

4

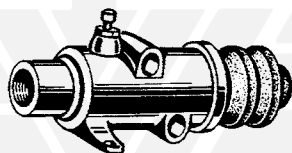

718043
21

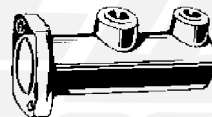

718007
22



716563
23



716565
24



732003
25

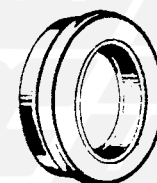

728522
26

FIG. ITEM	RIF. ERREVI ERREVI REF.	DESCRIZIONE PARTICOLARI DESCRIPTION	TIPO VEHICLE MODEL	RIF. ORIG. ORIG. REF.
1 35NC - 40NC - 45NC - 49NC 50.8/F8 - 55.8/F8 - 60.8/F8				
1	718038	Cilindretto comando disinnesto / <i>Slave cylinder</i>		4311345 (ex 4191164)
2	718046	Cilindro maestro comando disinnesto / <i>Master cylinder</i>	50.8/F8 - 55.8/F8 - 60.8/F8	4797845 (ex 4217083)
3	718213	Cilindro maestro comando disinnesto / <i>Master cylinder</i>	35NC - 40NC - 45NC - 49NC	4800161 (ex 4166208)
4	717054	Leva a forcella disinnesto / <i>Withdrawal lever</i>		4605179
5	716587	Manicotto portareggispinta nudo / <i>Withdrawal sleeve</i>		-
6	716588	Manicotto portareggispinta con cuscinetto / <i>Withdrawal sleeve assy</i>		4605181
7	732029	Molla richiamo manicotto / <i>Sleeve spring</i>		4607761
8	728529	Reggispinta distacco (SKF 630086 A) / <i>Thrust bearing</i>	ø 50x81,7x22	4614120
2 50.9Z - 60.11 TURBO Z - 65.9Z - 65.12 TURBO Z 79.12 TURBO Z - 79.14 U.T. - 95.14 U.T. - 95.14Z - 109.14 U.T. - 109.14Z				
9	718047	Cilindretto comando disinnesto / <i>Slave cylinder</i>		4848576 (ex 4770993)
10	718046	Cilindro maestro comando disinnesto / <i>Master cylinder</i>		4797845
11	717068	Leva a forcella disinnesto / <i>Withdrawal lever</i>	65.12 TURBO Z - 79.12 TURBO Z 79.14 U.T. - 95.14/.14Z - 109.14/.14Z	8586051 (ex 8584071)
12	728543	Manicotto portareggispinta con cuscinetto / <i>Withdrawal sleeve assy</i>	50.9Z - 60.11 TURBO Z - 65.9Z	8587214
3 60/65NC - 70NC - 75NC 50.9/F9 - 50.10/F10 - 55.9/F9 - 55.10/F10 60.10/F10 - 65.10/F10 - 70.10/F10 - 75.10/F10 - 79.10/F10				
13	718038	Cilindretto comando disinnesto / <i>Slave cylinder</i>		4311345 (ex 4191164)
14	718047	Cilindretto comando disinnesto / <i>Slave cylinder</i>	U.T.	4848576 (ex 4770993)
15	718046	Cilindro maestro comando disinnesto / <i>Master cylinder</i>		4797845 (ex 4217083)
16	716591	Manicotto portareggispinta nudo / <i>Release bearing carrier</i>		-
17	716592	Manicotto portareggispinta con cuscinetto / <i>Withdrawal sleeve assy</i>		8582291
18	732003	Molla richiamo manicotto portareggispinta / <i>Return spring</i>	60/65NC - 70NC - 75NC 75.10/F10 - 79.10/F10	541369
19	728527	Reggispinta distacco / <i>Thrust bearing</i>	ø 50x84,2x22 60/65NC - 70NC - 75NC	541743
20	728529	Reggispinta distacco (SKF 630086) / <i>Thrust bearing</i>	ø 50x81,7x22 50.9/F9 - 50.10/F10 - 55.9/F9 55.10/F10 - 60.10/F10 - 65.10/F10 70.10/F10 - 75.10/F10 - 79.10/F10	4614120
4 645/650 N2/ N3 - 655 662 N2/ N3				
21	718043	Cilindretto comando disinnesto / <i>Slave cylinder</i>		4271838 (ex 4221755)
22	718007	Cilindro maestro comando disinnesto / <i>Master cylinder</i>		4657683 (ex 4146273)
23	716563	Manicotto portareggispinta / <i>Withdrawal sleeve</i>		-
24	716565	Manicotto portareggispinta con cuscinetto / <i>Withdrawal sleeve assy</i>		4605262
25	732003	Molla richiamo manicotto / <i>Return spring</i>		991701
26	728522	Reggispinta distacco (SKF 615644) / <i>Thrust bearing</i>	ø 60x97x24	1905136 (ex 4614121)

1

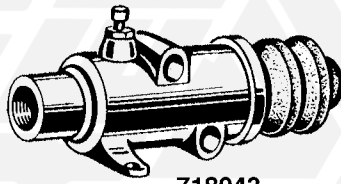

718043
1

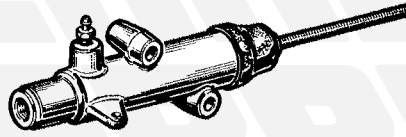

718038
2

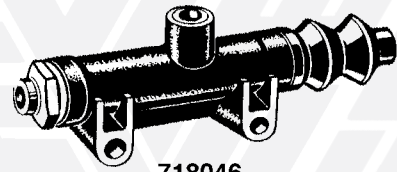

718046
3

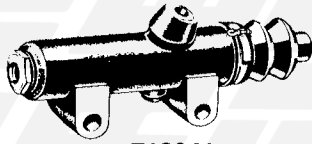

718041
4

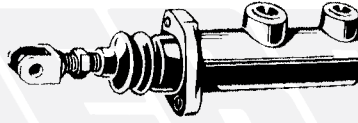

718007
5



716563
6

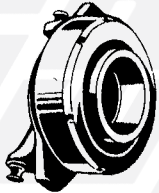

716565
7

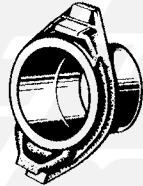

716589
8

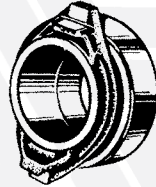

716590
9

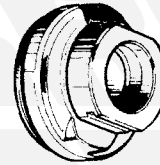

716594
10

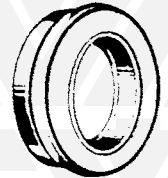

728522
11

2

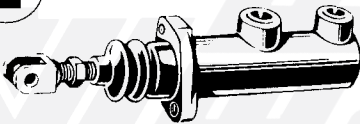

718217
12

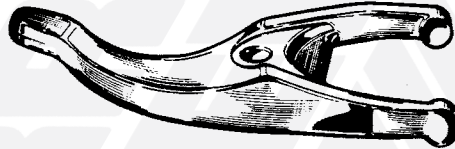

717067
13



728260
14

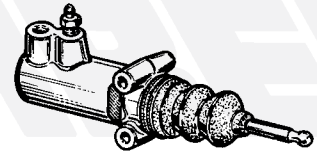

718216
15

3



718007
16

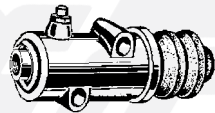

718243
17



732029
18



731721
19



728260
20

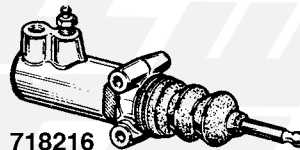

718216
21

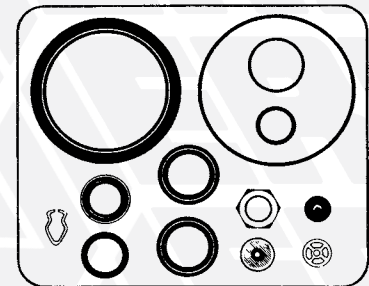

711280
22

NEW

4

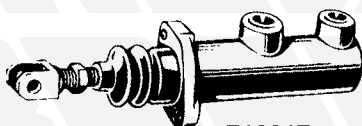

718217
23

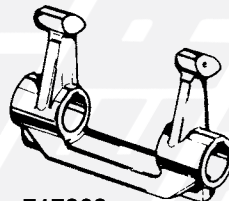

717060
24

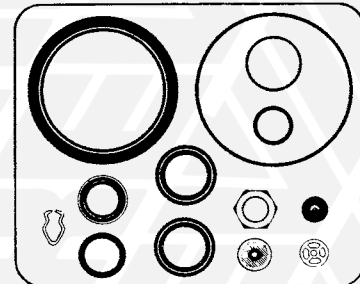

711280
26



731721
25

FIG. ITEM	RIF. ERREVI ERREVI REF.	DESCRIZIONE PARTICOLARI DESCRIPTION	TIPO VEHICLE MODEL	RIF. ORIG. ORIG. REF.
1 80NC - 90NC - 100NC - 110NC - 110.14 80.14 - 80.16 - 79.13/F13 - 80.13/F13 90.13/F13 - 100.13/F13				
1	718043	Cilindretto comando disinnesto / <i>Slave cylinder</i>	80NC - 90NC - 100NC - 110NC 110.14 - 80.14 - 80.16	4295958 (ex 4271838)
2	718038	Cilindretto comando disinnesto 2ª Serie / <i>Slave cylinder</i>	80NC - 90NC - 79.13/F13 80.13/F13 - 90.13/F13 - 100.13/F13	4191164
3	718046	Cilindro maestro comando disinnesto / <i>Master cylinder</i>	80NC - 90NC - 79.13/F13 80.13/F13 - 90.13/F13 - 100.13/F13	4797845 (ex 4217083)
4	718041	Cilindro maestro comando disinnesto / <i>Master cylinder</i>	80.14 - 80.16	4292543
5	718007	Cilindro maestro comando disinnesto / <i>Master cylinder</i>	100NC - 110NC - 110.14	4657683
6	716563	Manicotto portareggispinta / <i>Withdrawal sleeve</i>	80NC - 90NC - 100NC - 110NC 110.14 - 80.14 - 80.16	-
7	716565	Manicotto portareggispinta con cuscinetto <i>Withdrawal sleeve assy</i>	80NC - 90NC - 100NC - 110NC 110.14 - 80.14 - 80.16	4605262
8	716589	Manicotto portareggispinta 2ª Serie / <i>Withdrawal sleeve</i>	80NC - 90NC - 100NC - 110NC 79.13/F13 - 80.13/F13 90.13/F13 - 100.13/F13	-
9	716590	Manicotto portareggispinta con cuscinetto <i>Withdrawal sleeve assy</i>	80NC - 90NC - 100NC - 110NC 79.13/F13 - 80.13/F13 90.13/F13 - 100.13/F13	8564269
10	716594	Manicotto distacco frizione con reggispinta <i>Withdrawal sleeve assy</i>	75.13 - 80.13 - 90.13 - 110.13 - 130.13	42061921 (ex 2475547 - 2565803 - 42003396)
11	728522	Reggispinta distacco (RIV 615644) / <i>Thrust bearing</i>	∅ 60x97x24	1905136 (ex 4614121)
2 115.14 - 115.17 - 135.14 - 135.17 145.17 - 175.17				
12	718217	Cilindro maestro comando disinnesto / <i>Master cylinder</i>		4774874
13	717067	Leva a forcella disinnesto / <i>Withdrawal lever</i>		4773745
14	728260	Perno con sfera appoggio leva disinnesto / <i>Ball pin</i>		4577306
15	718216	Pompa disinnesto frizione / <i>Master cylinder</i>	115.17 - 135.14/ .17 - 145.17	4777521 (ex 4769389)
3 130NC - 150NC20 - 159.20				
16	718007	Cilindro maestro comando disinnesto / <i>Master cylinder</i>		4657683 (ex 4219866)
17	718243	Cilindro comando frizione / <i>Clutch cylinder</i>		4271840 (ex 4221757)
18	732029	Molla richiamo manicotto / <i>Sleeve spring</i>		4607761
19	731721	Membrana completa / <i>Diaphragm c/w pin</i>		9921881
20	728260	Perno con sfera appoggio leva disinnesto / <i>Ball pin</i>		4577306
21	718216	Pompa disinnesto frizione / <i>Master cylinder</i>	150NC20 - 159.20	4777521 (ex 4769389)
22	711280	Serie guarnizioni e valvoline per revisione servofrizione / <i>Repair kit</i>		9981242
4 165.24R/ .24T - 175.24R/ .24T				
23	718217	Cilindro maestro comando disinnesto / <i>Master cylinder</i>		4774874 (ex 4756348)
24	717060	Leva disinnesto / <i>Withdrawal lever</i>		4702081
25	731721	Membrana completa / <i>Diaphragm c/w pin</i>		9921881
26	711280	Serie guarnizioni e valvoline per revisione servofrizione / <i>Repair kit</i>		9981242
27	731719	Valvolina / <i>Valve</i>		9921880

1

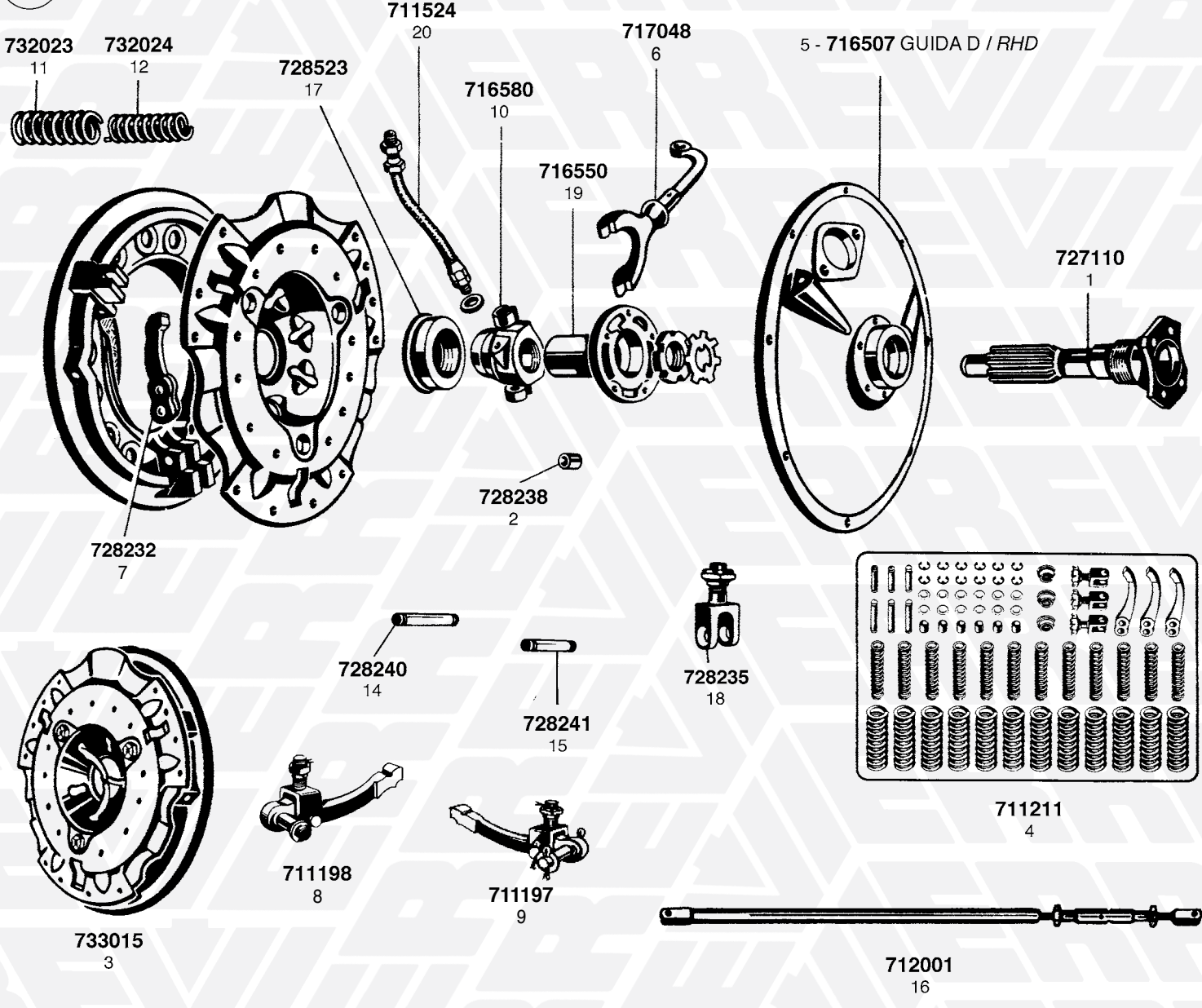

2

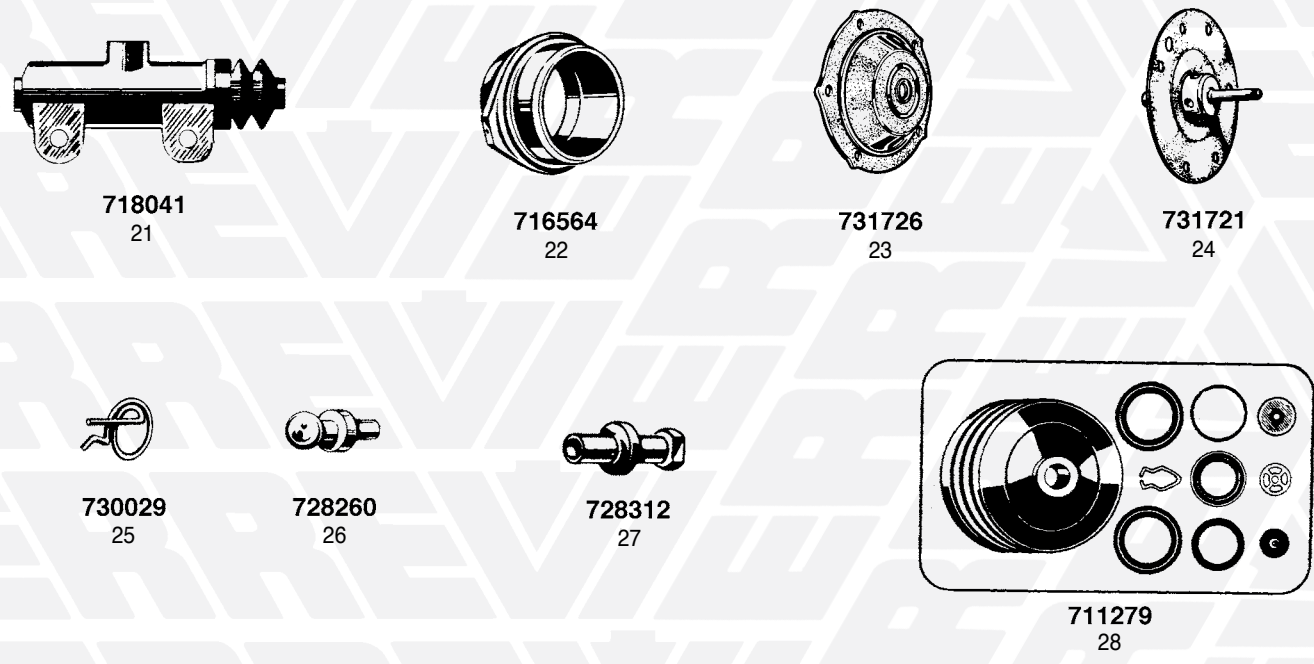
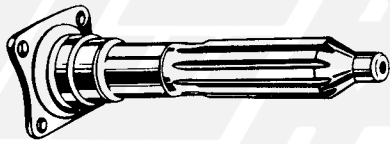
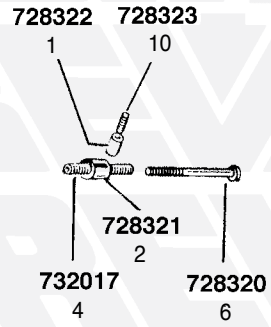
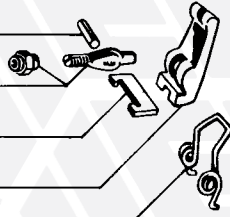

FIG. ITEM	RIF. ERREVI ERREVI REF.	DESCRIZIONE PARTICOLARI DESCRIPTION	TIPO VEHICLE MODEL	RIF. ORIG. ORIG. REF.
<div style="text-align: center;"> 1 682N3 - 682N4 - 682T3 - 682T4 </div>				
1	727110	Albero frizione rinforzato / <i>Shaft</i>		880878
2	728238	Boccola per levetta in metallo antifrizione / <i>Finger ferrule</i>	ø 12x14x15	4550885
3	733015	Complessivo frizione equilibrato / <i>Sub-assembly</i>		-
4	711211	Complessivo revisione frizione composto da: Repair kit, inclusive of: levette - supporti - perni - mollette - molle spingidisco <i>fingers - eyebolts - eyebolt pins - springs - outer and inner springs</i>		-
5	716507	Coperchio per frizione in alluminio / <i>Cover</i>		854840
6	717048	Leva a forcella disinnesto / <i>Withdrawal lever</i>		4552869
7	728232	Levetta distacco / <i>Finger</i>		4550884
8	711198	Levetta completa montata con seeger / <i>Finger assy</i>		-
9	711197	Levetta completa montata con copiglie / <i>Finger assy</i>		-
10	716580	Manicotto portareggispinta / <i>Withdrawal sleeve</i>		4561428
11	732023	Molla esterna spingidisco / <i>Outer spring</i>		4036875
12	732024	Molla interna spingidisco / <i>Inner spring</i>		4036876
13	732022	Molla per supportino levetta / <i>Spring</i>		670366
14	728240	Perno per supp. levetta lungo con scanalatura seeger / <i>Release lever pin</i>	ø 12x54	4561424
15	728241	Perno per supp. levetta corto con scanalatura seeger / <i>Release lever pin</i>	ø 12x43	4561425
16	712001	Puntone registrabile completo / <i>Rod</i>		850817
17	728523	Reggispinta distacco (606297 RIV) / <i>Thrust bearing</i>	ø 65x95,5x22,5	894827
18	728235	Supporto per levetta con dado / <i>Finger support c/w nut</i>		-
19	716550	Supporto manicotto portareggispinta / <i>Sleeve support</i>		626144
20	711524	Tube flessibile grassaggio reggispinta / <i>Grease line</i>		744462
<div style="text-align: center;"> 2 684N/NP - 160NC/NT </div>				
21	718041	Cilindro maestro comando disinnesto / <i>Master cylinder</i>		4292543 (ex 4241597)
22	716564	Manicotto portareggispinta / <i>Withdrawal sleeve</i>		4672298 (ex 4629910)
23	731726	Membrana per stantuffo / <i>Diaphragm</i>		9925656
24	731721	Membrana completa / <i>Diaphragm c/w pin</i>		9921881
25	732029	Molla richiamo manicotto disinnesto / <i>Sleeve spring</i>		4607761
26	728260	Perno a sfera appoggio leva disinnesto / <i>Ball pin</i>		4577306
27	728312	Registro per puntone disinnesto / <i>Clevis</i>		4641784
28	711279	Serie guarnizioni e valvoline per revisione servofrizione / <i>Repair kit</i>		9921884
29	731719	Valvolina / <i>Valve</i>		9921880

**FRIZIONE
CLUTCH**

1

- 7 - 728219
- 9 - 728223
- 8 - 728220
- 3 - 728222
- 5 - 732011



727112
11

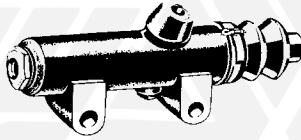

718041
12



717049
14

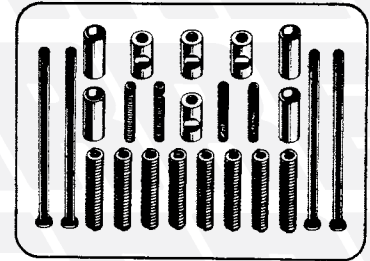

711210
13

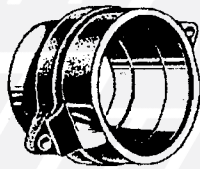

716581
15



716582
16



716584
17

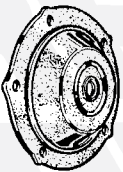

731726
18

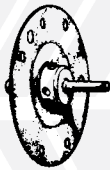

731721
19



732003
20



732029
21



728260
22



728312
23



728525
24

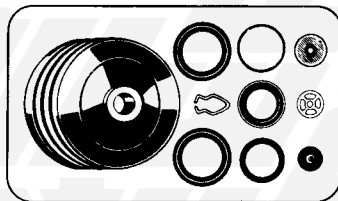

711279
25

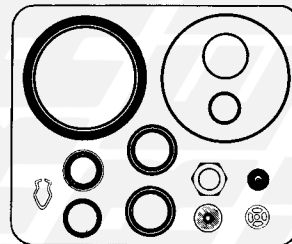

711280
26

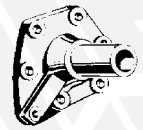

716553
27

FIG. ITEM	RIF. ERREVI ERREVI REF.	DESCRIZIONE PARTICOLARI DESCRIPTION	TIPO VEHICLE MODEL	RIF. ORIG. ORIG. REF.
<div style="display: flex; align-items: center;"> <div style="border: 1px solid black; border-radius: 50%; width: 30px; height: 30px; display: flex; align-items: center; justify-content: center; margin-right: 10px;"> 1 </div> <div> <p style="margin: 0;">180NC - 619N1</p> <p style="margin: 0;">300PC</p> </div> </div>				
1	728322	Boccolina per guida vite / <i>Ferrule</i>		9917866
2	728321	Boccolina per molletta / <i>Ferrule</i>		9918072
3	728222	Levetta distacco / <i>Release lever</i>		9927584 (ex 9916666)
4	732017	Molla per boccolina / <i>Ferrule spring</i>		9918071
5	732011	Molla richiamo levetta distacco / <i>Release lever spring</i>		9916640
6	728320	Pernetto per boccolina con molla / <i>Pin</i>		9927586 (ex 9917867)
7	728219	Pernetto per supporto levetta / <i>Release lever pin</i>		9916644
8	728220	Piastrina appoggio levetta / <i>Release lever strut</i>		9916638
9	728223	Supportino per levetta con dado / <i>Eyebolt c/w nut</i>		9917858 (ex 9916637)
10	728323	Vite per boccolina di guida / <i>Dowel</i>		9917865
11	727112	Albero frizione / <i>Shaft</i>		4625869
12	718041	Cilindro maestro comando disinnesto / <i>Master cylinder</i>		4292543 (ex 4700150)
13	711210	Complessivo pernetti e boccoline per spingidisco intermedio composto da: Repair kit, inclusive of: 4 pernetti - 4 boccoline - 4 boccoline per viti - 4 viti - 8 mollette 4 pins - 4 ferrules - 4 bushings - 4 screws - 8 springs		-
14	717049	Leva a forcella disinnesto / <i>Withdrawal lever</i>		4630065
15	716581	Manicotto portareggispinta / <i>Withdrawal sleeve</i>		4517066
16	716582	Manicotto portareggispinta / <i>Withdrawal sleeve</i>		4672296 (ex 4624483)
17	716584	Manicotto portareggispinta con cuscinetto <i>Withdrawal sleeve assy</i>		-
18	731726	Membrana per stantuffo / <i>Diaphragm</i>		9925656
19	731721	Membrana completa / <i>Diaphragm c/w pin</i>		9921881
20	732003	Molla richiamo manicotto / <i>Sleeve spring</i>	693N1	4007194
21	732029	Molla richiamo manicotto / <i>Sleeve spring</i>		4607761
22	728260	Perno con sfera appoggio leva disinnesto / <i>Ball pin</i>		4577306
23	728312	Registro per puntone / <i>Clevis</i>		4641784
24	728525	Reggispinta distacco (RIV 630098) / <i>Thrust bearing</i>	ø 75x117x26	4675388 (ex 4624485)
25	711279	Serie guarnizioni e valvoline per revisione servofrizione / <i>Repair kit</i>		9921884
26	711280	Serie guarnizioni e valvoline per revisione servofrizione / <i>Repair kit</i>	300PC U.T.	9981242
27	716553	Supporto manicotto portareggispinta / <i>Sleeve support</i>		4630064
28	731719	Valvolina / <i>Valve</i>		9921880

**FRIZIONE
CLUTCH**

1

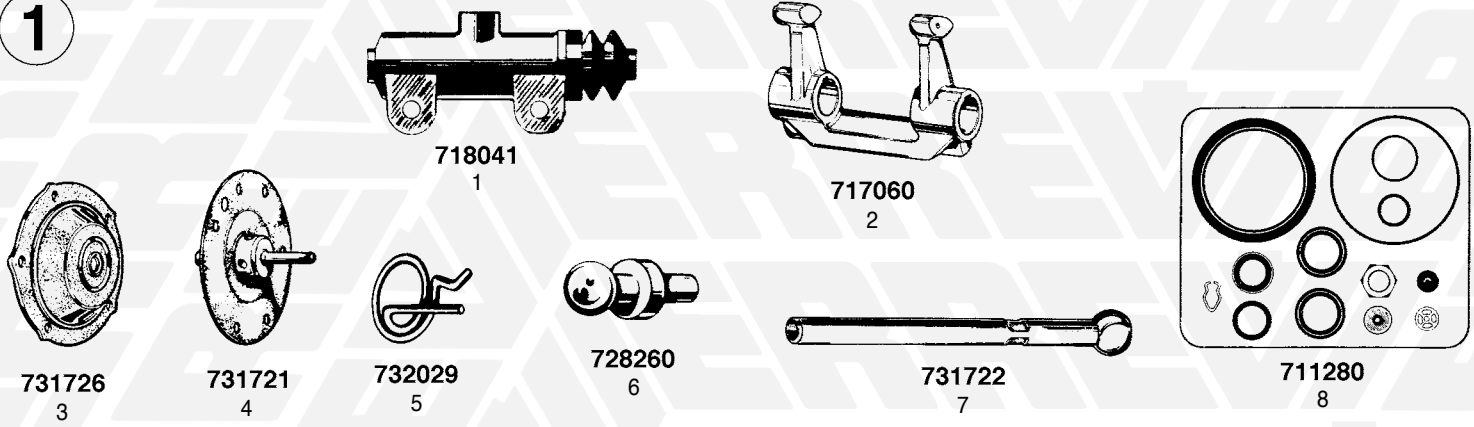

2

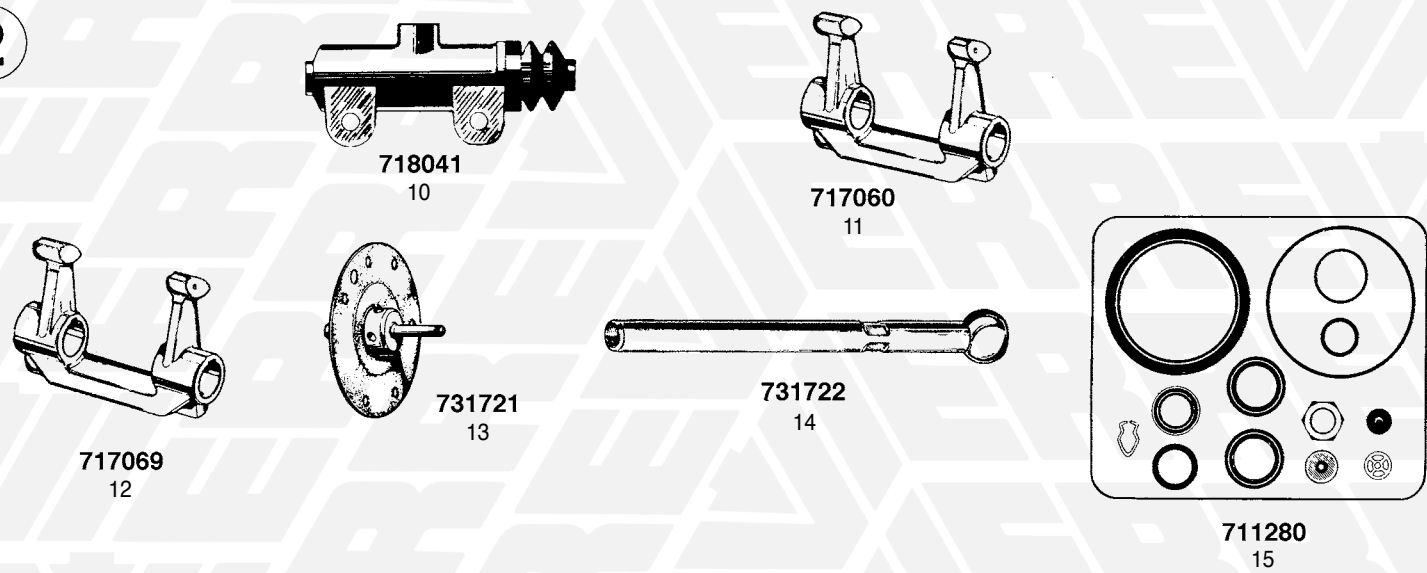

3

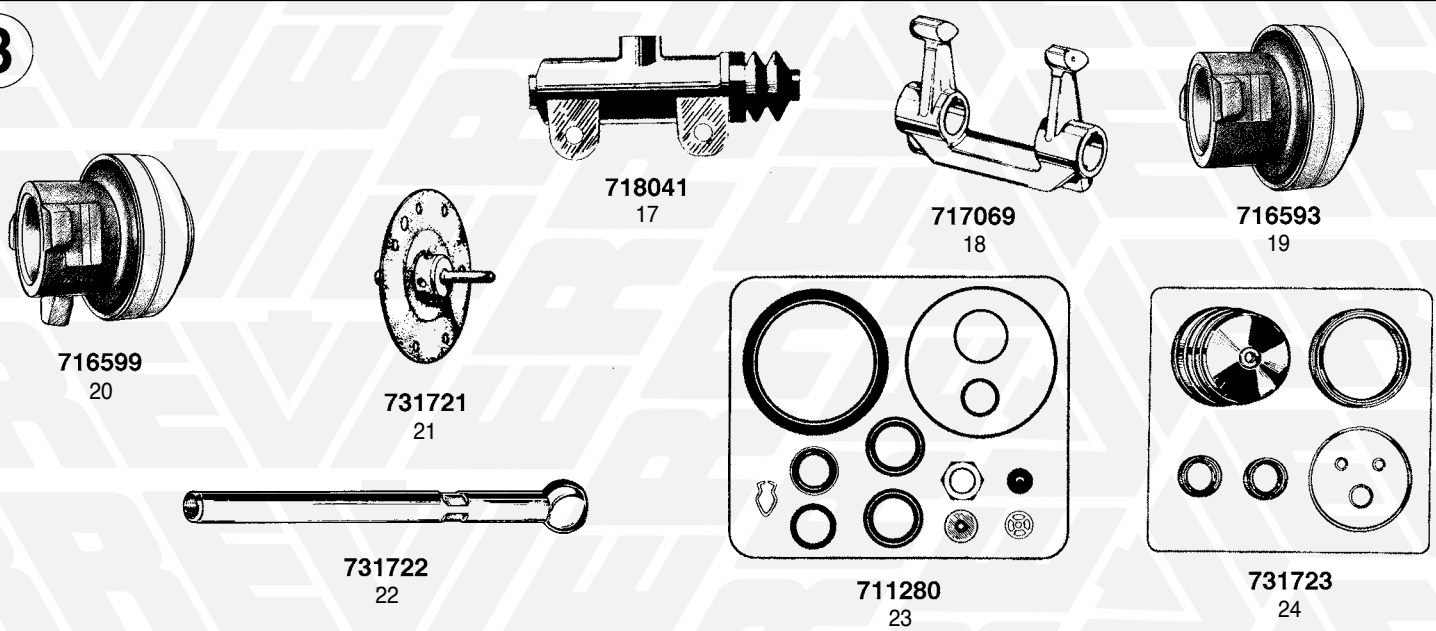

4

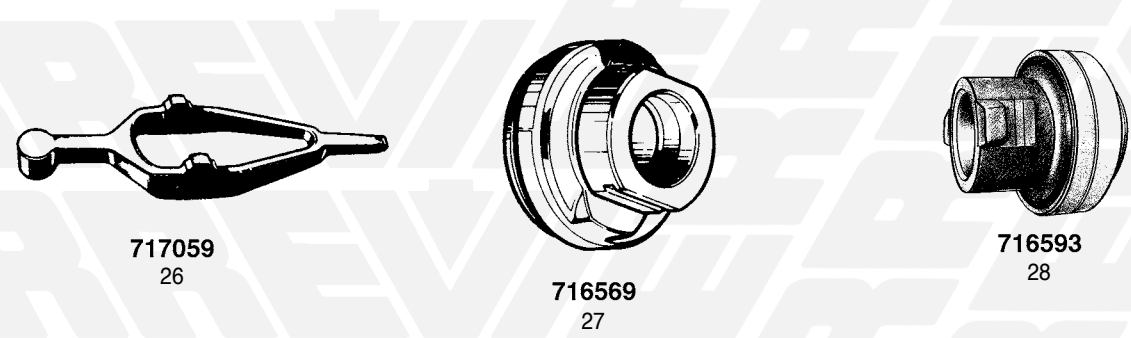
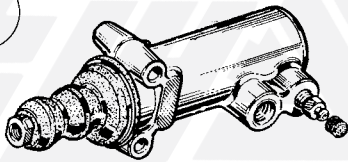
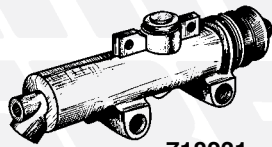

FIG. ITEM	RIF. ERREVI ERREVI REF.	DESCRIZIONE PARTICOLARI DESCRIPTION	TIPO VEHICLE MODEL	RIF. ORIG. ORIG. REF.
1 170/190NC26 - NT26 - NC33 - NT33 - 170NC35 - NT35 170/190F26 - F26T - F35 - F35T				
1	718041	Cilindro maestro comando disinnesto / <i>Master cylinder</i>		4292543
2	717060	Leva a forcella disinnesto / <i>Withdrawal lever</i>	170/190NC33 - NT33 170NC35 - NT35 170/190F35 - F35T	4702081
3	731726	Membrana per stantuffo / <i>Diaphragm</i>	170/190NC e derivati	9925656
4	731721	Membrana completa / <i>Diaphragm c/w pin</i>		9921881
5	732029	Molla richiamo manicotto portareggispinta / <i>Sleeve spring</i>	170/190NC26 - NT26 - F26-F26T	4607761
6	728260	Perno con sfera appoggio leva disinnesto / <i>Ball pin</i>	170/190NC26 - NT26 - F26-F26T	4577306
7	731722	Puntale di regolazione per asta servofrizione / <i>Adjusting rod</i>	170/190NC26-NT26-NC33-NT33 170NC35 - NT35	4675799
8	711280	Serie guarnizioni e valvoline per revisione servofrizione / <i>Repair kit</i>	170/190F26 - F26T - F35 - F35T	9981242
9	731719	Valvolina / <i>Valve</i>		9921880
2 180.24/ .24T/ .26 - 190i26/ i26T/ i35/ i35T 190.30 - 220F35T				
10	718041	Cilindro maestro comando disinnesto / <i>Master cylinder</i>	180.26 - 190i26/ i26T/ i35/ i35t 190.30 - 220F35T	4292543
11	717060	Leva a forcella disinnesto / <i>Withdrawal lever</i>	180.24/ .24T/ .26 - 190i35/ i35T 190.30	4702081
12	717069	Leva a forcella disinnesto-CAMBIO ZF- / <i>Withdrawal lever (ZF Gearbox)</i>	190.30	4746189
13	731721	Membrana completa / <i>Diaphragm c/w pin</i>		9921881
14	731722	Puntale di regolazione per asta servofrizione / <i>Adjusting rod</i>	180.26 - 190i26/ i26T/ i35/ i35t 190.30 - 220F35T	4675799
15	711280	Serie guarnizioni e valvoline per revisione servofrizione / <i>Repair kit</i>		9981242
16	731719	Valvolina / <i>Valve</i>		9921880
3 190.33 - 190.42 - 190.38/ .38T - 220.38PT TURBOSTAR				
17	718041	Cilindro maestro comando disinnesto / <i>Master cylinder</i>		4292543
18	717069	Leva a forcella disinnesto / <i>Withdrawal lever</i>	190.38 - 190.33 - 190.36 - 190.42	4746189
19	716593	Manicotto distacco frizione con reggispinta / <i>Withdrawal sleeve assy</i>	190.33 - 190.42	8193332 (ex 42062095 - 93163685)
20	716599	Manicotto distacco frizione con reggispinta / <i>Withdrawal sleeve assy</i>	190.48	504222042
21	731721	Membrana completa / <i>Diaphragm c/w pin</i>		9921881
22	731722	Puntale di regolazione per asta servofrizione / <i>Adjusting rod</i>		4675799
23	711280	Serie guarnizioni e valvoline per revisione servofrizione / <i>Repair kit</i>		9981242
24	731723	Serie guarnizioni per revisione servofrizione U.T. / <i>Repair kit</i>		8124434
25	731719	Valvolina / <i>Valve</i>		9921880
4 330F26/ .26 - 330.30 - 330F35/ .35				
26	717059	Leva a forcella disinnesto / <i>Withdrawal lever</i>		42003011
27	716569	Manicotto distacco c/reggispinta / <i>Withdrawal sleeve assy</i>		42063184 (ex 42003473)
28	716593	Manicotto distacco frizione con reggispinta <i>Withdrawal sleeve assy</i>	330.26H	8193332 (ex 42062095 - 93163685)

1



718225
1



718231
2

NEW

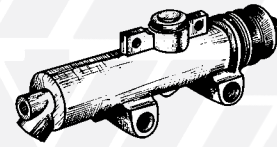

718232
3

NEW

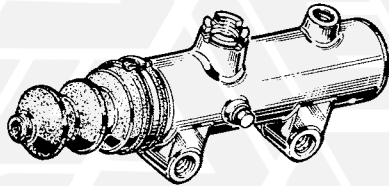

718226 - 718229 - 718242
6 5 4

NEW

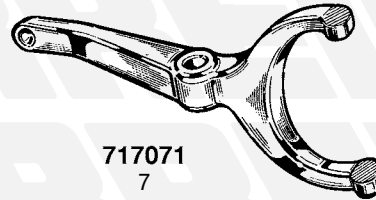

717071
7

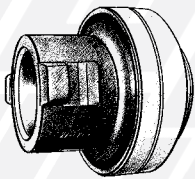

716595
8

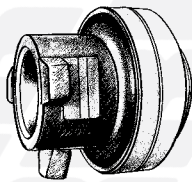

716599
9



716596
10

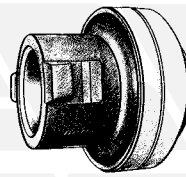

716598
11

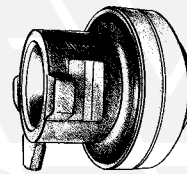

716597
12

2

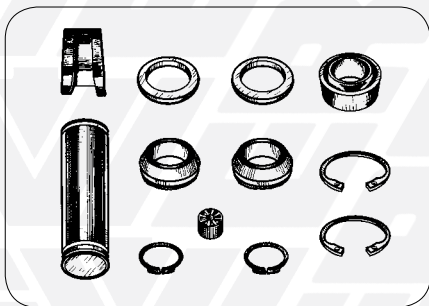

711206
13

NEW

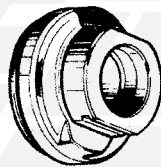

716594
14

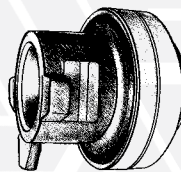

716602
15



716603
16

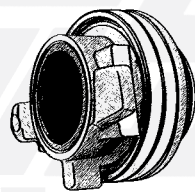

716604
17

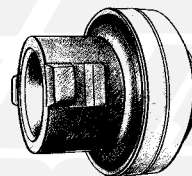

716595
18

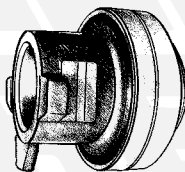

716597
19

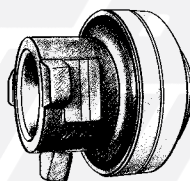

716599
20

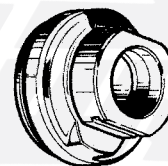

716569
21

FIG. ITEM	RIF. ERREVI ERREVI REF.	DESCRIZIONE PARTICOLARI DESCRIPTION	TIPO VEHICLE MODEL	RIF. ORIG. ORIG. REF.
<div style="display: flex; justify-content: space-between;"> <div style="width: 15%;"> <p>1</p> </div> <div style="width: 60%;"> <p>EUROCARGO EUROCARGO "TECTOR" EUROTECH EUROSTAR EUROTRAKKER EUROTECH "CURSOR" EUROSTAR "CURSOR" EUROTRAKKER "CURSOR"</p> </div> <div style="width: 20%;"> <p>130E24/E28 - 150E24/E28 - 180E24/E28 - 320E28T 190E24/E31/E35 - 260E24/E31/E35 - 440E31/E35 190E43-440E39/E43 190E35-260E31/E35 - 340E35-380E35-410E35</p> </div> </div>				
1	718225	Cilindretto comando disinnesto / <i>Slave cylinder</i>	EUROCARGO	4854828
2	718231	Cilindro comando frizione / <i>Clutch cylinder</i>	EUROTECH - EUROTRAKKER EUROTRAKKER CURSOR - STRALIS	41285355 (ex 41211005)
3	718232	Cilindro comando frizione / <i>Clutch cylinder</i>	EUROTECH - EUROTRAKKER EUROTRAKKER CURSOR - STRALIS	41285356 (ex 41211006)
4	718242	Cilindro comando frizione / <i>Clutch cylinder</i>	EUROCARGO 60E14 - 65E14 - 75E14	8604136
5	718229	Cilindro com. disinn. / <i>Master cylinder</i>	EUROCARGO	4853409
6	718226	Cilindro com. disinn. / <i>Master cylinder</i>	ø pist. 28 <i>piston ø 28</i>	4853408
7	717071	Leva forcella disinnesto / <i>Withdrawal lever</i>	EUROCARGO	42115302
8	716595	Manicotto distacco frizione con reggispinta / <i>Withdrawal sleeve assy</i>	EUROCARGO - EUROCARGO "Tector" EUROTECH - EUROSTAR EUROTRAKKER - STRALIS	500305439
9	716599	Manicotto distacco frizione con reggispinta / <i>Withdrawal sleeve assy</i>	EUROCARGO - EUROTECH EUROSTAR - EUROTRAKKER - STRALIS	504222042
10	716596	Manicotto distacco frizione con reggispinta / <i>Withdrawal sleeve assy</i>	EUROTECH	1905470 (ex 42061853 - 42102316)
11	716598	Manicotto distacco frizione con reggispinta / <i>Withdrawal sleeve assy</i>	EUROTECH - EUROSTAR EUROTRAKKER EUROTRAKKER "Cursor" - STRALIS	504070593 (ex 500335068)
12	716597	Manicotto distacco frizione con reggispinta / <i>Withdrawal sleeve assy</i>	EUROTRAKKER - STRALIS	504237895
<div style="display: flex; justify-content: space-between;"> <div style="width: 15%;"> <p>2</p> </div> <div style="width: 60%;"> <p>MAN</p> </div> </div>				
13	711206	Compressivo revisione distacco frizione / <i>Clutch release fork repair kit</i>	L2000 - M2000 - TGA - TGL - TGM	81305606019 81305606022
14	716594	Manicotto distacco frizione con reggispinta / <i>Withdrawal sleeve assy</i>	M90 - L2000	81305500044 81305500060
15	716602	Manicotto distacco frizione con reggispinta / <i>Withdrawal sleeve assy</i>	F90 - F2000 - TGA - TGS - TGX	81305500087 81305500063 81305500067 81305500071 81305500073 81305500077 81305500088 81305500110 81305500116
16	716603	Manicotto distacco frizione con reggispinta / <i>Withdrawal sleeve assy</i>	F2000 - TGA - TGS - TGX	81305500085 81300007220
17	716604	Manicotto distacco frizione con reggispinta / <i>Withdrawal sleeve assy</i>	M2000 - TGL - TGM	81305500082
18	716595	Manicotto distacco frizione con reggispinta / <i>Withdrawal sleeve assy</i>	TGA - TGM - TGS - TGX	81305500096 81305500097 81305500104 81305500114
19	716597	Manicotto distacco frizione con reggispinta / <i>Withdrawal sleeve assy</i>	TGA - TGM - TGS - TGX	81305500251 81305500255 81305500249
20	716599	Manicotto distacco frizione con reggispinta / <i>Withdrawal sleeve assy</i>	TGA - TGM - TGS - TGX - TGL	81305500096 81305500114 81305500102 81305500101
21	716569	Manicotto distacco frizione con reggispinta / <i>Withdrawal sleeve assy</i>	BUS	81305500069 81305500078

FRIZIONE CLUTCH

1

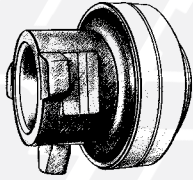

716599
1

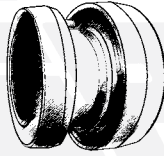

716606
2

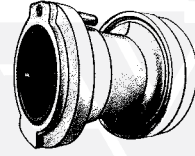

716607
3

2

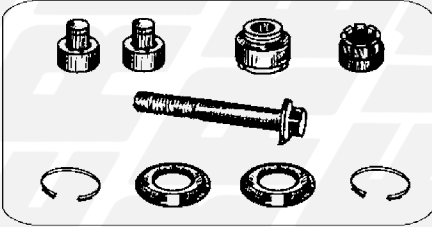

711203
4

NEW

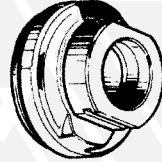

716594
5

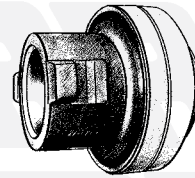

716595
6

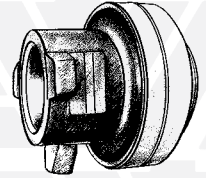

716599
7

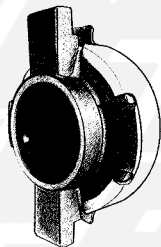

716603
8

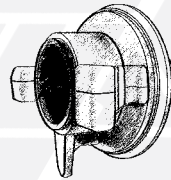

716608
9

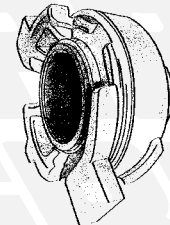

716609
10

3

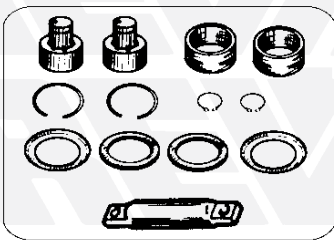

711212
11

NEW

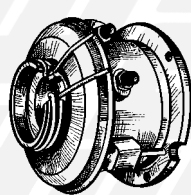

718233
12

NEW

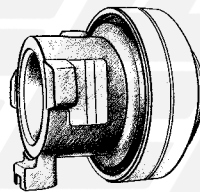

716611
13

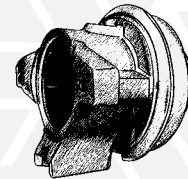

716612
14

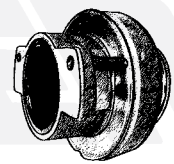

716613
15

4

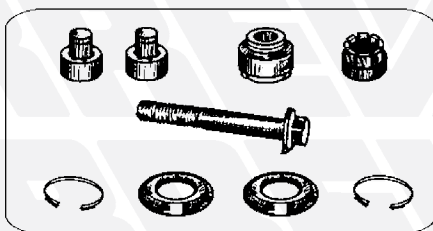

711203
16

NEW

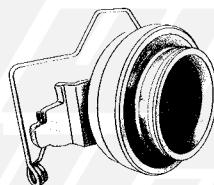

716614
17

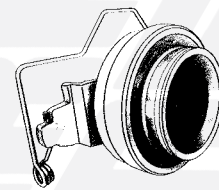

716615
18

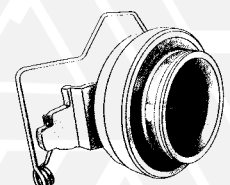

716616
19

FIG. ITEM	RIF. ERREVI ERREVI REF.	DESCRIZIONE PARTICOLARI DESCRIPTION	TIPO VEHICLE MODEL	RIF. ORIG. ORIG. REF.
<h2>1 MERCEDES</h2>				
1	716599	Manicotto distacco frizione con reggispinta / <i>Withdrawal sleeve assy</i>		0002543008
2	716606	Manicotto distacco frizione con reggispinta / <i>Withdrawal sleeve assy</i>	ATEGO AXOR - AXOR 2 ACTROS - ACTROS MP2	0022503715 0022509915
3	716607	Manicotto distacco frizione con reggispinta / <i>Withdrawal sleeve assy</i>	ATEGO AXOR - AXOR 2 ACTROS - ACTROS MP2	0022504115 0022506715 0022508115 0022509815
<h2>2 RENAULT</h2>				
4	711203	Complessivo revisione frizione / <i>Clutch release fork, repair kit</i>	MAGNUM - PREMIUM	74208062125
5	716594	Manicotto distacco frizione con reggispinta / <i>Withdrawal sleeve assy</i>	MIDLINER	5000613650 5000058221 5000240864 5000677075 5001866623 5001866625
6	716595	Manicotto distacco frizione con reggispinta / <i>Withdrawal sleeve assy</i>	PREMIUM MAGNUM	5001873287 5001864270 5010245921
7	716599	Manicotto distacco frizione con reggispinta / <i>Withdrawal sleeve assy</i>	PREMIUM MAGNUM MAGNUM E.TECH	5001873287 5001858682 5001864270
8	716603	Manicotto distacco frizione con reggispinta / <i>Withdrawal sleeve assy</i>	PREMIUM - MAGNUM MAGNUM E.TECH - KERAX	5010452025 5010545676
9	716608	Manicotto distacco frizione con reggispinta / <i>Withdrawal sleeve assy</i>	PREMIUM - MAGNUM - KERAX	5010244086 5010244204
10	716609	Manicotto distacco frizione con reggispinta / <i>Withdrawal sleeve assy</i>	PREMIUM - MAGNUM - KERAX	5010244202 5010244017
<h2>3 SCANIA</h2>				
11	711212	Complessivo revisione frizione / <i>Clutch release fork, repair kit</i>	Serie P - G - R - T Series Serie 4 Series	17373065
12	718233	Dispositivo disinnesto frizione / <i>Clutch disconnecting</i>	Serie 4 Series	551572 1123296 1393332 1434649 1455730 1522377
13	716611	Manicotto distacco frizione con reggispinta / <i>Withdrawal sleeve assy</i>	93 - 113 - 143	1393163 1321260
14	716612	Manicotto distacco frizione con reggispinta / <i>Withdrawal sleeve assy</i>	93 - 113 - 143 94 - 114 - 124 - 144 - 164	1393162 1373276
15	716613	Manicotto distacco frizione con reggispinta / <i>Withdrawal sleeve assy</i>	94 - 114 - 124 - 144 - 164	1749125 1728165 1851631
<h2>4 VOLVO</h2>				
16	711203	Complessivo revisione frizione / <i>Clutch release fork, repair kit</i>	FM7 - FM12 FH12 - FH16	208062125 31919675
17	716614	Manicotto distacco frizione con reggispinta / <i>Withdrawal sleeve assy</i>	FL10 - FL12 FM9 - FM12 FH12 - FH16 B10	1655843 1668921 1672944 20569157
18	716615	Manicotto distacco frizione con reggispinta / <i>Withdrawal sleeve assy</i>	FL12 FM7 - FM9 - FM10 - FM12 FH12	3192217 1655732 1667258
19	716616	Manicotto distacco frizione con reggispinta / <i>Withdrawal sleeve assy</i>	FM7 - FM12 FH12	3192221 1521767 20569155