

DIFFERENZIALE E MOZZI POSTERIORI REAR AXLE AND WHEELS

RICAMBI PER / SPARE PARTS FOR

ASTRA	pag.	94 - 95
DAF	pag.	94 - 95
IVECO	pag.	96 - 115
MAN	pag.	116 - 117
MERCEDES	pag.	118 - 119
NISSAN	pag.	118 - 119
RENAULT	pag.	120 - 121
SCANIA	pag.	122 - 123
VOLVO	pag.	124 - 127

PONTE POST.
REAR AXLE

1



729336
1

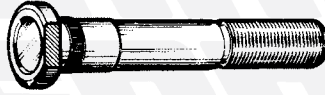

729055
2

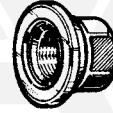

729657
3



728910
4

2



729629
8



6 - 729342
7 - 729341



729398
5

NEW



729784
9

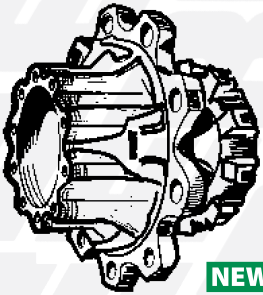

NEW

713907
Nudo / Bare
10

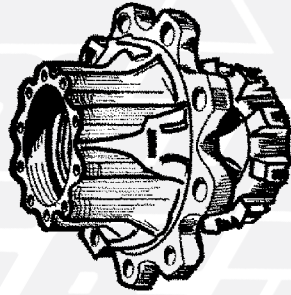

713758
Compl. / Assembly
11

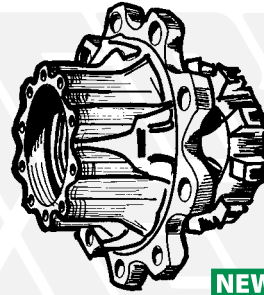

NEW

713906
Compl. FAG / FAG Assembly
12



728701
16

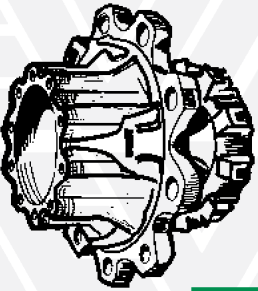

NEW

713909
Nudo / Bare
13

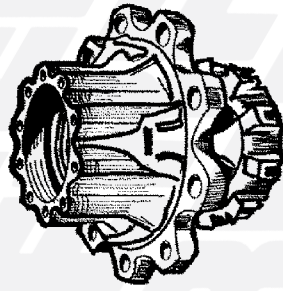

713773
Compl. / Assembly
14



NEW

713908
Compl. FAG / FAG Assembly
15



728701
16



730783
23

NEW



730784
24

NEW



25 - 730782
26 - 730781

NEW



726375
27

NEW



726376
28

NEW



727259
29



17 - 728722
18 - 728723
19 - 728724
20 - 728725
21 - 728727
22 - 728729

NEW



727262
30

NEW

FIG. ITEM	RIF. ERREVI ERREVI REF.	DESCRIZIONE PARTICOLARI DESCRIPTION		TIPO VEHICLE MODEL	RIF. ORIG. ORIG. REF.
<div style="display: flex; align-items: center;"> <div style="font-size: 2em; margin-right: 10px;">1</div> <div> <h2 style="margin: 0;">ASTRA</h2> <p style="margin: 0;">BM20 - BM21F - BM304F - BM305F - BM64.26 - BM64.30 - BM64.36 HD7 (64.34 - 64.38 - 64.42 - 64.45 - 64.52) - HD8 (4x2 - 4x4 - 6x4 - 6x6 - 8x4)</p> </div> </div>					
1	729336	Colonna fissaggio mozzi / <i>Wheel stud</i>	M22x1,5 L=107	BM304F - BM305F	101788 (ex 103253)
2	729055	Colonna fissaggio mozzi / <i>Wheel stud</i>	M22x1,5 L=111	BM 64.26/.30/.36 HD7 (64.34/.38/.42/.45/.52) HD8 (4x2 - 4x4 - 6x4 - 6x6 - 8x4)	112329 115498 42061641 42101367 (ex 111445)
3	729657	Dado per colonna / <i>Wheel nut</i>	M22x1,5	HD8 (4x2 - 4x4 - 6x4 - 6x6 - 8x4)	40051
4	728910	Tassello fissaggio ruota - foro \varnothing 20 / <i>Wheel pad, hole \varnothing 20</i>		BM20 - BM21F	16320
<div style="display: flex; align-items: center;"> <div style="font-size: 2em; margin-right: 10px;">2</div> <div> <h2 style="margin: 0;">DAF</h2> </div> </div>					
5	729398	Colonna fissaggio ruota / <i>Wheel stud</i>	M20x1,5 L=85	LF45 - LF55	1400065 PAK4938
6	729342	Colonna fissaggio ruota / <i>Wheel stud</i>	M22x1,5 L=94	85CF - 85FA - 95FA - 95XF	1309190 1356736 890763
7	729341	Colonna fissaggio ruota / <i>Wheel stud</i>	M22x1,5 L=104	2100 - 2300 - 2500 - 2800 - 3600	620649 99717 1308038
8	729629	Dado per colonna / <i>Wheel nut</i>	M22x1,5	2100 - 2300 - 2500 - 2800 - 3600	652575
9	729784	Dado fissaggio mozzo / <i>Wheel nut</i>	M86x2		1396548
10	713907	Mozzo ruota nudo / <i>Wheel hub, bare</i>		XF95 - 95XF	13916075 16576375 18180035 13889065
11	713758	Mozzo ruota completo / <i>Wheel hub assembly</i>		XF95 - 95XF	1391617 1657637 1818003 1388906
12	713906	Mozzo ruota completo di cuscinetto FAG / <i>Wheel hub assembly (complete with FAG bearing)</i>		XF95 - 95XF	1391617 1657637 1818003 1388906
13	713909	Mozzo ruota nudo / <i>Wheel hub, bare</i>		XF95 - 95XF	18121615
14	713773	Mozzo ruota completo U.T. / <i>Wheel hub assembly</i>		XF95 - 95XF	1812161
15	713908	Mozzo ruota con cuscinetto FAG / <i>Wheel hub assembly (with FAG bearing)</i>		XF95 - 95XF	1812161
16	728701	Kit cuscinetto completo / <i>Bearing assembly</i>	\varnothing est. 148	XF95 - 95XF	1801594
17	728722	Cuscinetto mozzo / <i>Hub bearing</i>	\varnothing 90x140x32		0077060 32018XA VKHB2170
18	728723	Cuscinetto mozzo / <i>Hub bearing</i>	\varnothing 95x145x32	LF55 - 65CF	0622103 32019XA VKHB2161
19	728724	Cuscinetto mozzo / <i>Hub bearing</i>	\varnothing 100x150x32		699117 32020X VKHB2306
20	728725	Cuscinetto mozzo / <i>Hub bearing</i>	\varnothing 110x170x38		1453936 VKHB2281 32022X
21	728727	Cuscinetto mozzo / <i>Hub bearing</i>	\varnothing 105x160x43	65CF - 75CF - 85CF - 95FA - 95XF - CF65 CF75 - CF85 - XF195 - XF105 - LF45	266488-33021 VKHB2162
22	728729	Cuscinetto mozzo / <i>Hub bearing</i>	\varnothing 75x125x37		221664-33115 VKHB2222
23	730783	Paraolio interno mozzo / <i>Oil seal, inner</i>	\varnothing 100x135x13	65CF - 75CF - 85CF - 95XF	0647330
24	730784	Paraolio interno mozzo / <i>Oil seal, inner</i>	\varnothing 100x140x20	65CF - 75CF - 85CF - 95XF	1238034
25	730782	Paraolio interno mozzo / <i>Oil seal, inner</i>	\varnothing 120x164,5x19,5	65CF - 75CF	0678157
26	730781	Paraolio interno mozzo / <i>Oil seal, inner</i>	\varnothing 124,5x164,5x17,5	75CF - 85CF - 95XF - CF65 - CF75 - CF85	0292766
27	726375	Rondella fissaggio mozzo / <i>Retaining washer</i>	\varnothing 69,5x119x9	LF55 - CF65 - CF75 - CF85 - XF95 - XF105	1692215
28	726376	Rondella fissaggio mozzo / <i>Retaining washer</i>	\varnothing 69,5x119x9	XF95 - XF105	1692209 1385327
29	727259	Ruota fonica / <i>Impulse wheel</i>	100 denti 100 teeth	CF65 - CF75 - CF85	1805824 (ex 1657638)
30	727262	Ruota fonica / <i>Impulse wheel</i>	\varnothing 168x212x18 100 denti 100 teeth	65CF - 75CF - 85CF - CF65 CF75 - CF85	1391517 1805823

**PONTE POST.
REAR AXLE**

1



729501
1

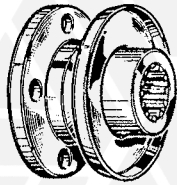

715011
2

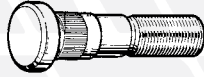

729106
3



729183
4



729184
5



729149
6



729347
7



729626
8



729763
9



728650
11

NEW

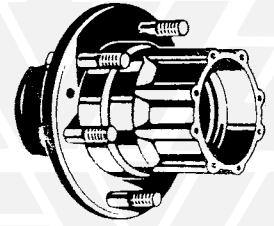

713590
10



728713
13

NEW

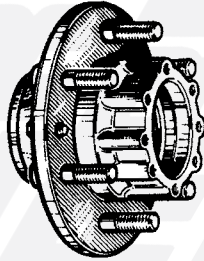

713526
12



728670
15

NEW

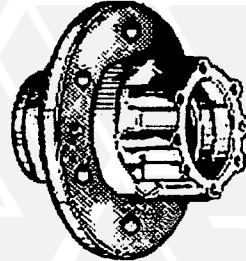

713625
14



730738
16



730768
17

2

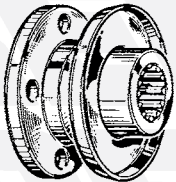

715011
18



729184
19



729626
20



729763
21



728713
23

NEW

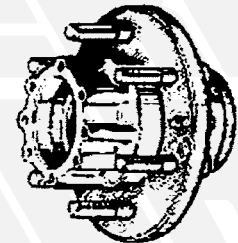

713526
22

3



729024
24



729044
28



729043
27



729026
25



726823
26

FIG. ITEM	RIF. ERREVI ERREVI REF.	DESCRIZIONE PARTICOLARI DESCRIPTION	TIPO VEHICLE MODEL	RIF. ORIG. ORIG. REF.
1 IVECO DAILY - NEW DAILY - TURBO DAILY (30.8 - 30.10 - 35.8 - 35.10 - 35.12 - 40.8 - 40.10 - 45.10 - 49.10 - 49.12) GRUPPO DIFFERENZIALE / DIFFERENTIAL GROUP				
1	729501	Dado per manicotto pignone / Pinion nut	40.8	7166475 (ex 545701 - 4696423)
2	715011	Manicotto pignone conico / Pinion driving flange	30.10 - 35.10 - 35.12 - 40.10 45.10 - 49.10 - 49.12	7166992
MOZZI POSTERIORI / REAR HUBS				
3	729106	Colonna fiss. ruota (ponte salisbury) / Wheel stud (salisbury rear axle)	M18x1,5 L=68	32.8 - 35.8 - 40.8
4	729183	Colonna fiss. ruota (ponte FIAT) 1ª Serie / Wheel stud (FIAT rear axle)		30.8 - 35.8
5	729184	Colonna fiss. ruota U.T. / Wheel stud	M18x1,5 L=58	7168330 42119082
6	729149	Colonna fiss. ruota / Wheel stud	M18x1,5 L=65	2478620 42117463 46390478
7	729347	Colonna fissaggio ruota / Wheel stud	M18x1,5 L=75	59.12
8	729626	Dado per colonna / Wheel nut	M18x1,5	42117465 (ex 7168333)
9	729763	Ghiera fissaggio mozzo / Grooved nut	M52x1,5	TUTTI I TIPI
10	713590	Mozzo ruota c/colonne - RUOTE GEMELLATE - Rear hub assy - twin wheels -		NO 49.12 - 59.12
11	728650	Cuscinetto interno ed esterno mozzo / Hub bearing	ø 55x90x23	DAILY - NEW DAILY - TURBO DAILY 30.8/.10 - 35.8/.10/.12 40.8/.10 - 45.10 - 49.10
12	713526	Mozzo ruota posteriore con colonne / Rear hub c/w bolts		TUTTI I TIPI
13	728713	Kit cuscinetto completo / Bearing assembly	ø 55x90x60	NEW DAILY 35.8 TURBO DAILY 35.10/.12 - 49.10/.12 DAILY CNG 35.11 - 49.11
14	713625	Mozzo ruota, nudo / Rear hub, bare		7180049
15	728670	Cuscinetto interno ed esterno mozzo / Hub bearing	ø77,8x121,5 x25,2	7187566 (ex 7180066) VKBA3552
16	730738	Paraolio mozzi / Oil seal	ø70x90x12	7172993
17	730768	Paraolio interno mozzo in VITON / Oil seal (VITON material)	ø 95x130x16	TURBO DAILY 59.12 DAILY CNG 59.11
18	715011	Manicotto pignone conico / Pinion driving flange		40100483 (ex 40002630)
2 DAILY 2000 35C9/C10/C11/C12/C13/C15 - 50C11/C13/C15 GRUPPO DIFFERENZIALE / DIFFERENTIAL GROUP				
19	729184	Colonna fiss. ruota U.T. / Wheel stud	M18x1,5 L=58	59.11 DAILY CNG
20	729626	Dado per colonna / Wheel nut	M18x1,5	7185250 (ex 40102143)
21	729763	Ghiera fissaggio mozzo / Grooved nut	M52x1,5	7168330
22	713526	Mozzo ruota posteriore con colonne / Rear hub c/w bolts		93805743 99474404 (ex 4459602)
23	728713	Kit cuscinetto completo / Bearing assembly	ø 55x90x60	7180039
3 35NC - 40NC - 45NC - 49NC - 50NC - 55NC - 65NC - 70NC - 75NC				
24	729024	Colonna fissaggio ruota / Wheel stud	M18x1,5 L=72	7180049
25	729026	Dado per colonna / Wheel nut	M18x1,5	7187566 (ex 7180066) VKBA3552
26	726823	Fermo per ghiera mozzo / Lockwasher		8527732
27	729043	Rondella spaccata per colonna / Lockwasher		15501521
28	729044	Rondella conica per colonna / Cone washer		8515168

PONTE POST. REAR AXLE

1

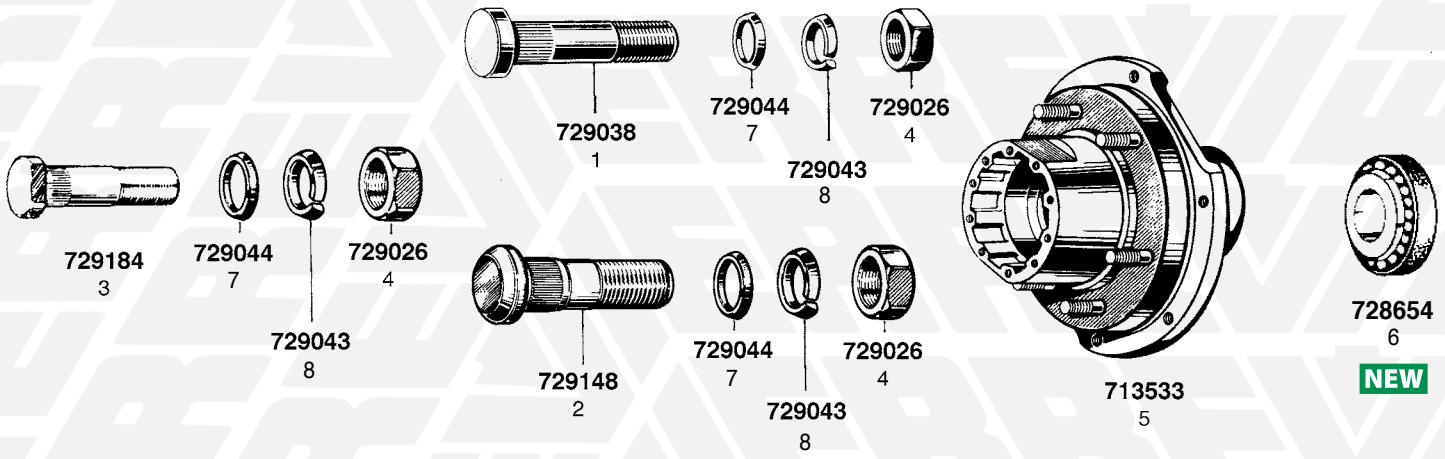

2

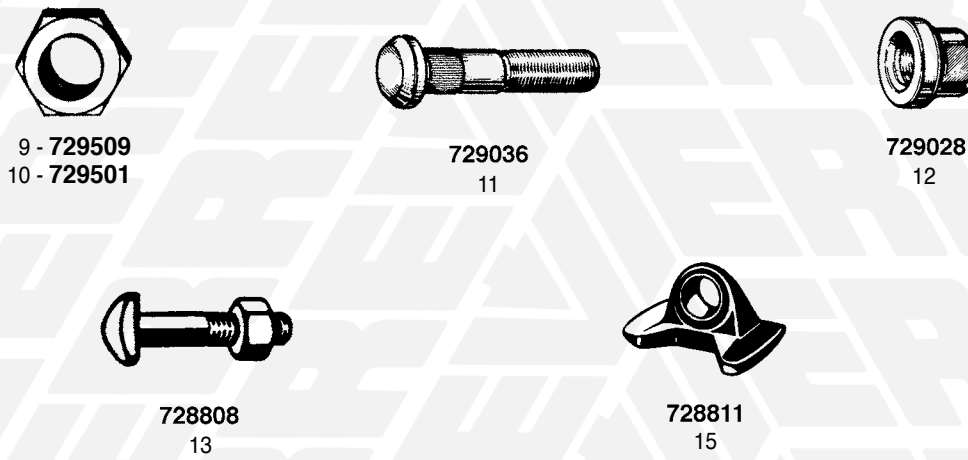

3

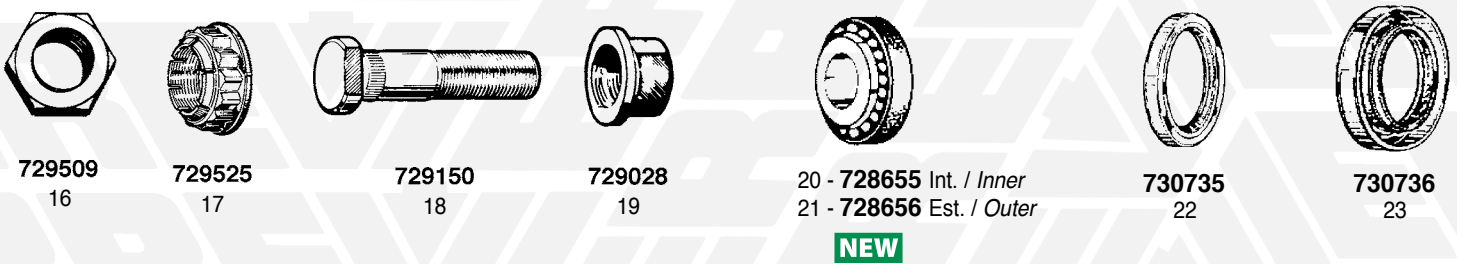

4

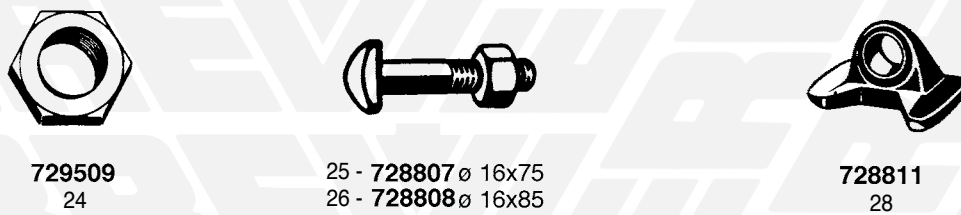

FIG. ITEM	RIF. ERREVI ERREVI REF.	DESCRIZIONE PARTICOLARI DESCRIPTION	TIPO VEHICLE MODEL	RIF. ORIG. ORIG. REF.
1 50.8/F8 - 50.9/F9 - 50.9Z - 50.10/F10 - 55.8/F8 - 55.9/F9 - 55.10/F10 - 60.8/F8 60.10/F10 - 60.11 TURBO Z - 65.9Z - 65.10/F10 - 65.12 TURBO Z 70.10/F10 - 75.10/F10 - 79.10/F10 - 79.12 TURBO Z - 79.13/F13 - 79.14 - 79.14Z				
1	729038	Colonna fissaggio ruota 1ª Serie / Wheel stud	M18x1,5 L=55	7161201
2	729148	Colonna fissaggio ruota 2ª Serie / Wheel stud	M18x1,5 L=55	7161552
3	729184	Colonna fissaggio ruota U.T. / Wheel stud	M18x1,5 L=58	7168346
4	729026	Dado per colonna / Wheel nut	M18x1,5	15501521 (ex 15501524)
5	713533	Mozzo ruota con colonnette / Rear hub assy		4686447 4686446 (ex 7168365)
6	728654	Cuscinetto interno ed esterno mozzo (VKHB2154) Hub bearing	ø 70x110x25 TUTTI I TIPI	1905216 (ex 7164410)
7	729044	Rondella conica per colonna / Cone washer		8527735
8	729043	Rondella spaccata per colonna / Lockwasher		1121808 (ex 8527733)
2 80NC - 90NC - 80.13/F13 - 90.13/F13 - 100.13/F13 - 110.14 GRUPPO DIFFERENZIALE / DIFFERENTIAL GROUP				
9	729509	Dado per manicotto pignone / Pinion nut	M35x1,5	4685835 (ex 4611483)
10	729501	Dado per manicotto pignone / Pinion nut	M28x1,5 80NC - 90NC	7166475 (ex 545701)
MOZZI POSTERIORI / REAR HUBS				
11	729036	Colonna fissaggio ruota / Wheel stud	M20x1,5 L=77,5	7161203
12	729028	Dado per colonna / Wheel nut	M20x1,5	2476979
13	728808	Bullone raggiera con dado / Wheel stud	M16x2 L=85 80NC - 90NC	4532460
14	728750	Dado per bullone raggiera / Wheel nut	M16x2 80NC - 90NC	4517201
15	728811	Tassello fissaggio ruota / Wheel pad	80NC - 90NC	4529999
3 109.14 - 115.17 - 135.14 - 135.17 GRUPPO DIFFERENZIALE / DIFFERENTIAL GROUP				
16	729509	Dado per manicotto pignone 1ª Serie / Pinion nut	M35x1,5	4685835
17	729525	Dado per manicotto pignone U.T. / Pinion nut	M39x1,5	7984882
MOZZI POSTERIORI / REAR HUBS				
18	729150	Colonna fissaggio ruota / Wheel stud	M20x1,5 L=87	2475863
19	729028	Dado per colonna / Wheel nut	M20x1,5	2476979
20	728655	Cuscinetto interno ed esterno mozzo (VKHB2080) Hub bearing	ø 85x150x38,5	1905172 (ex 7164544)
21	728656	Cuscinetto esterno mozzo / Hub bearing, outer (VKHB2137)	ø 75x120x31	7166346
22	730735	Paraolio esterno mozzi / Oil seal, outer	ø 130x100x14	40100113 (ex 40100110)
23	730736	Paraolio interno mozzi / Oil seal, inner	ø 152x134x14	40001790 40100050
4 100NC - 110NC - 130NC GRUPPO DIFFERENZIALE / DIFFERENTIAL GROUP				
24	729509	Dado per manicotto pignone / Pinion nut	M35x1,5 100NC - 110NC - 130NC	4685835 (ex 4611483)
MOZZI POSTERIORI / REAR HUBS				
25	728807	Bullone raggiera con dado / Wheel stud	M16x2 L=75	4517528
26	728808	Bullone raggiera con dado / Wheel stud	M16x2 L=85	4532460
27	728750	Dado per bullone raggiera / Wheel nut	M16x2	4517201
28	728811	Tassello fissaggio ruota / Wheel pad		4529999

1



729525
1



NEW



729173
2



3 - 729629 CH 32 - H 31
4 - 729657 CH 32 - H 27

5 - 728655 Est. / Outer
6 - 728657 Int. / Inner

2



729145
7



726535
9



729046
10



729029
8

3



729506
11



12 - 729519
13 - 729502

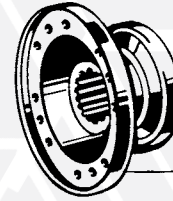

715003
14



19 - 730674 Est. / Outer
18 - 730708 Int. / Inner



15 - 728821 18x105
16 - 728822 18x125



20 - 728904
21 - 728905

4



729511
22



23 - 728821 18x105
24 - 728822 18x125



730708
26



728905
27

FIG. ITEM	RIF. ERREVI ERREVI REF.	DESCRIZIONE PARTICOLARI DESCRIPTION	TIPO VEHICLE MODEL	RIF. ORIG. ORIG. REF.	
1 145.17 GRUPPO DIFFERENZIALE / DIFFERENTIAL GROUP					
1	729525	Dado per manicotto pignone / Pinion nut	M39x1,5	7984882	
MOZZI POSTERIORI / REAR HUBS					
2	729173	Colonna fissaggio ruota / Wheel stud	M22x1,5 L=92	7168595	
3	729629	Dado per colonna 1ª Serie / Wheel nut	M22x1,5 H=31	4459603	
4	729657	Dado per colonna U.T. / Wheel nut	M22x1,5 H=27 CH32	41036367 (ex 41031725)	
5	728655	Cuscinetto interno ed esterno mozzo / Hub bearing	ø 85x150 x38,5	109.14-115.17-135.14-135.17-145.17 TURBOSTAR 190.30/.38 220.36PT/.38PT 190.33/.36/.42/.48-240.36/.48 TURBOTECH 190.24/.26/.30 240.26 - 260.30 - 260.36/.48 E.CARGO-EUROTECH-EUROSTAR	1905172 (ex 7164544) VKHB2080
6	728657	Cuscinetto interno mozzo / Hub bearing, inner	ø 96x170 x46,5	145.17	7164543 VKHB2210
2 175.17 - 175.24R/ .24T					
7	729145	Colonna fissaggio ruota / Wheel stud	M22x1,5 L=101	7168465 42117453	
8	729029	Dado per colonna / Wheel nut	M22x1,5	41800483	
9	726535	Rondella conica per colonna / Cone washer		3420371	
10	729046	Rondella spaccata per colonna / Lockwasher		504023611 (ex 1121811)	
3 682N3/ N4 - 684NP - 619N1 - 160NC - 160.26 - 170/190NC26/ NC33/ NT33 170NC35 - 170/190F26/ F35 - 180NC GRUPPO DIFFERENZIALE / DIFFERENTIAL GROUP					
11	729506	Dado per pignone cilindrico / Pinion nut	M50x1,5	4698939 (ex 4542054)	
12	729519	Dado per pignone conico / Pinion nut	M50x1,5	682N3/N4 - 684NP 619N1 - 160NC - 180NC	8532165
13	729502	Dado per pignone conico / Pinion nut	M50x1,5	682N3/ N4 U.T. - 170/190 160.26	4689843
14	715003	Manicotto per pignone conico / Pinion driving flange		4619754	
MOZZI POSTERIORI / REAR HUBS					
15	728821	Bullone raggiera con dado / Wheel stud	M18x2,5 L=105	865558	
16	728822	Bullone raggiera con dado / Wheel stud	M18x2,5 L=125	-	
17	728751	Dado per bullone raggiera / Wheel nut	M18x2,5	865559	
18	730708	Paraolio interno mozzo / Oil seal, inner	ø 200x180x15	40000691	
19	730674	Paraolio esterno mozzo / Oil seal, outer	ø 168x150x13	40000950 (ex 4573796)	
20	728904	Tassello fissaggio ruota / Wheel pad		682N3/ N4 - 690N3/ N4 - 691 180NC	743587
21	728905	Tassello fissaggio ruota / Wheel pad		619N1 - 684NP - 160NC 170/190 - 160.26	743587
4 697N/NP - 300PC GRUPPO DIFFERENZIALE / DIFFERENTIAL GROUP					
22	729511	Dado fiss. forcella sul pignone 1°-2° differenziale / Mainshaft nut	M40x1,5	697N/NP - 300PC	4608818
MOZZI POSTERIORI E INTERMEDI / MIDDLE AND REAR AXLE					
23	728821	Bullone raggiera con dado / Wheel stud	M18x2,5 L=105	865558	
24	728822	Bullone raggiera con dado / Wheel stud	M18x2,5 L=125	-	
25	728751	Dado per bullone raggiera / Wheel nut	M18x2,5	865559	
26	730708	Paraolio interno mozzo / Oil seal, inner	ø 200x180x15	40000691	
27	728905	Tassello fissaggio ruota / Wheel pad		743587	

**PONTE POST.
REAR AXLE**

1



720169

1



720168

2



730720

3



729084

5



729145 - 729055 - 729351

7

6

8



726535

22



729046

21



729029

9



726535

22



729046

21



729029

9

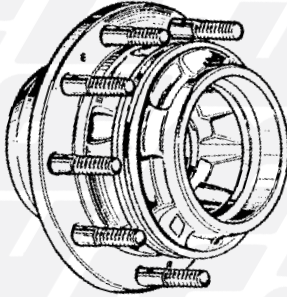

14 - 713545
15 - 713582



16 - 728658 Int. / Inner
17 - 728659 Est. / Outer

NEW



729728

11



730739

18

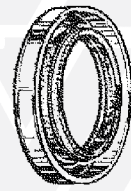

730769

19

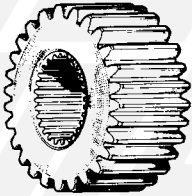

731798

12

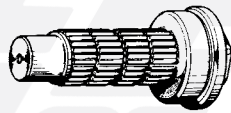

728537

20

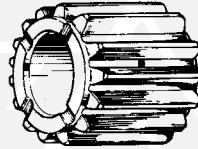

731800

13



728379

4



726237

23

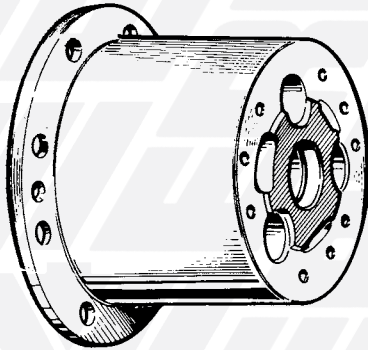

792074

23

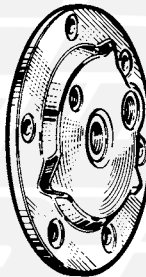

716520

10

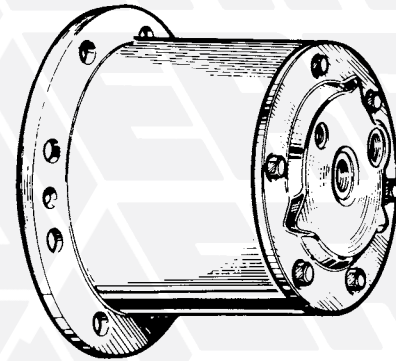

792075

25

2



729145

26



726535

36



729046

35



729029 - 729629

27

28

729657

29

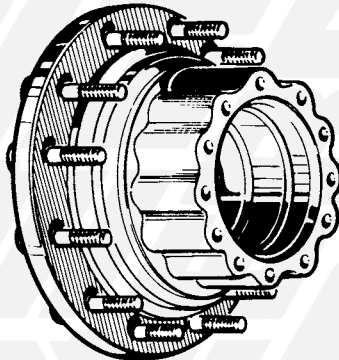

713552

30



31 - 728655 Int. / Inner
32 - 728662 Est. / Outer

NEW



730739

33



730769

34



727254

37

FIG. ITEM	RIF. ERREVI ERREVI REF.	DESCRIZIONE PARTICOLARI DESCRIPTION	TIPO VEHICLE MODEL	RIF. ORIG. ORIG. REF.
1 180.24/ .26 - 190i26/ i35 - 190.30/ .38 - 220.38PT - 240.30P/ .38P GRUPPO DIFFERENZIALE / DIFFERENTIAL GROUP				
1	720169	Perno portasatellite corto / <i>Pinion spindle</i>	∅ 27x177	42063134
2	720168	Perno portasatellite lungo / <i>Pinion spindle</i>		42063135
MOZZI POSTERIORI / REAR HUBS				
3	730720	Anello di tenuta per mozzo / <i>Oil seal</i>		42061628 (ex 42037594)
4	728379	Anello rasamento satellite / <i>Thrust washer</i>		42037800
5	729084	Colonna fissaggio ruota 1ª Serie / <i>Wheel stud</i>	M22x1,5 L=110	2477764
6	729055	Colonna fissaggio ruota 2ª Serie / <i>Wheel stud</i>	M22x1,5 L=111	42064826 42061641 42101367 (ex 2475869 - 42117455)
7	729145	Colonna fissaggio ruota U.T. / <i>Wheel stud</i>	M22x1,5 L=101	42127220 42117453
8	729351	Colonna fiss. ruota (cerchi in lega) / <i>Wheel stud (Alloy rims)</i>	M22x1,5 L=128,5	-
9	729029	Dado per colonna fissaggio ruota / <i>Wheel nut</i>	M22x1,5	41800483
10	716520	Coperchio per scatola riduttore / <i>Cover</i>		42062798 (ex 2476601)
11	729728	Dado bloccaggio mozzo / <i>Nut</i>	M82x1,5	3555488
12	731798	Ingranaggio centrale riduttore / <i>Axle shaft gear</i>		4459828
13	731800	Ingranaggio satellite riduttore / <i>Step-down gear</i>		42159023 (ex 4459829)
14	713545	Mozzo ruota completo di colonnette U.T. / <i>Rear hub</i>		42101959 (ex 42037491)
15	713582	Mozzo ruota completo di colonnette U.T. / <i>Wheel hub c/w studs</i>		42101361
16	728658	Cuscinetto interno mozzo (VKHB2215) <i>Hub bearing, inner</i>	∅ 105x190x41,3	1102864 (ex 26800090)
17	728659	Cuscinetto esterno mozzo / <i>Hub bearing, outer (VKHB2216)</i>	∅ 120x180x38	1103360
18	730739	Paraolio esterno mozzo / <i>Oil seal, outer</i>	∅ 200x180x12	40003720
19	730769	Paraolio esterno mozzo in VITON / <i>Oil seal, outer (VITON material)</i>	∅ 200x180x12	40100673
20	728537	Perno portasatellite / <i>Saddle pin</i>		2477919
21	729046	Rondella spaccata per colonna / <i>Lockwasher</i>		504023611 (ex 1121811)
22	726535	Rondella conica per colonna / <i>Cone washer</i>		3420371
23	726237	Rondella rasamento satellite / <i>Thrust washer</i>	∅ 29x51x1,3	2443705
24	792074	Scatola riduttore U.T. / <i>Transfer case housing</i>		42037489
25	792075	Scatola riduttore compl. di ingranaggi e coperchio U.T. / <i>Transfer case assy</i>		-
2 TURBOSTAR 190.30 U.T./ .38 U.T. - 220.36PT U.T./ .38PT U.T. 190.33/ .36/ .42/ .48 - 240.36/ .48 - 260.36/ .48 TURBOTECH 190.24/ .26/ .30 - 240.26 - 260.3				
26	729145	Colonna fiss. ruota / <i>Wheel stud</i>	M22x1,5 L=101	7168465 (ex 42026222)
27	729029	Dado per colonna / <i>Wheel nut</i>	M22x1,5 H=22	41800483
28	729629	Dado per colonna 1ª Serie / <i>Wheel nut</i>	M22x1,5 H=31	TURBOTECH 4459603
29	729657	Dado per colonna U.T. / <i>Wheel nut</i>	M22x1,5 H=27	TURBOTECH 41036367 (ex 41031725)
30	713552	Mozzo ruota completo di colonnette (senza ruota fonica e parapolvere) / <i>Wheel hub c/w studs</i>		7168464 7168589
31	728655	Cuscinetto interno ed esterno mozzo (VKHB2080) <i>Hub bearing</i>	∅ 85x150x38,5	1905172 (ex 7164544)
32	728662	Cuscinetto interno mozzo (VKHB221) <i>Hub bearing, inner</i>	∅ 105x190x53	7177004 (ex 26800270)
33	730739	Paraolio esterno mozzo / <i>Oil seal, outer</i>	∅ 200x180x12	40003720
34	730769	Paraolio esterno mozzo in VITON / <i>Oil seal, outer (VITON material)</i>	∅ 200x180x12	40100673
35	729046	Rondella spaccata per colonna / <i>Lockwasher</i>		504023611 (ex 1121811)
36	726535	Rondella conica per colonna / <i>Cone washer</i>		3420371
37	727254	Ruota fonica / <i>Impulse wheel</i>	∅ 202x218x24	190.30H - 330.30H/.36H 7166885

**PONTE POST.
REAR AXLE**

1

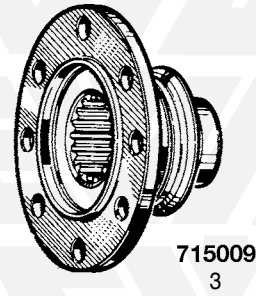
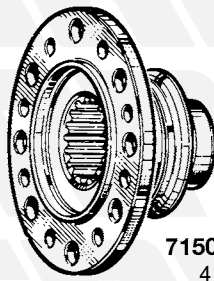
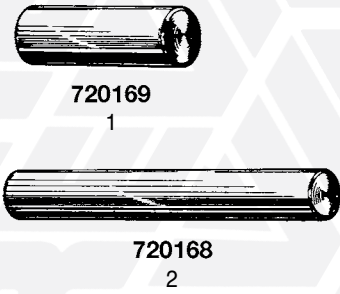

2

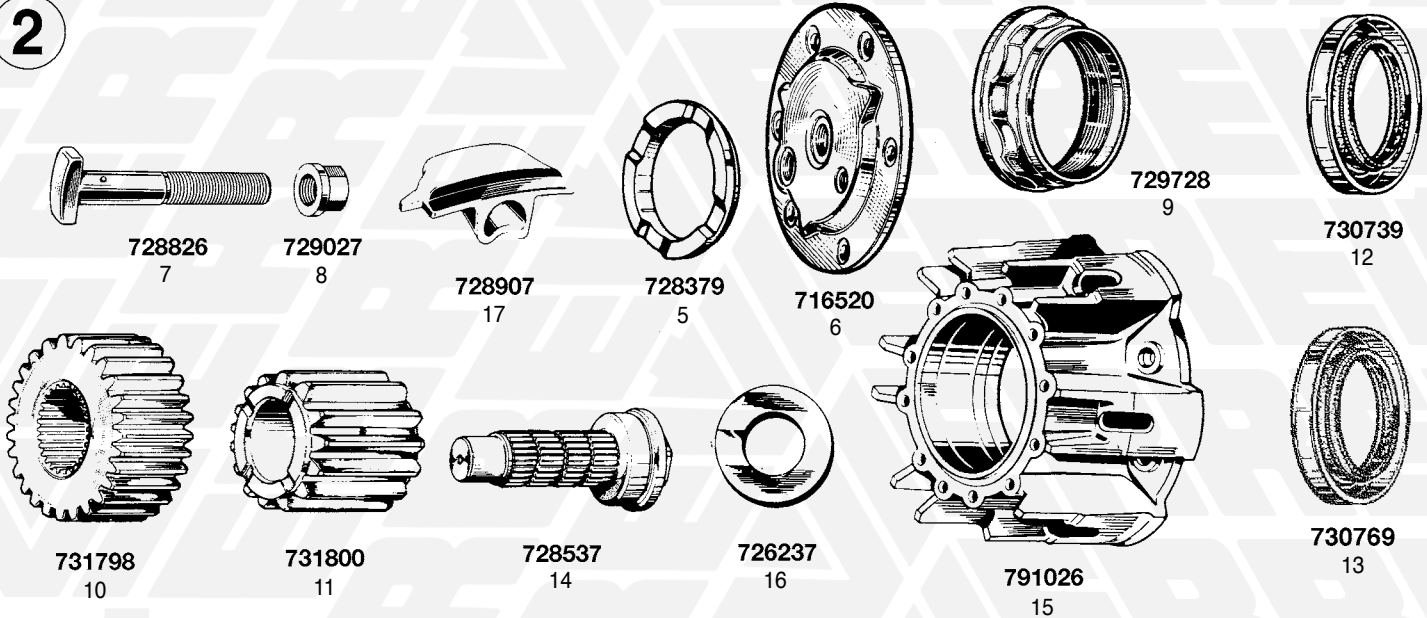

3

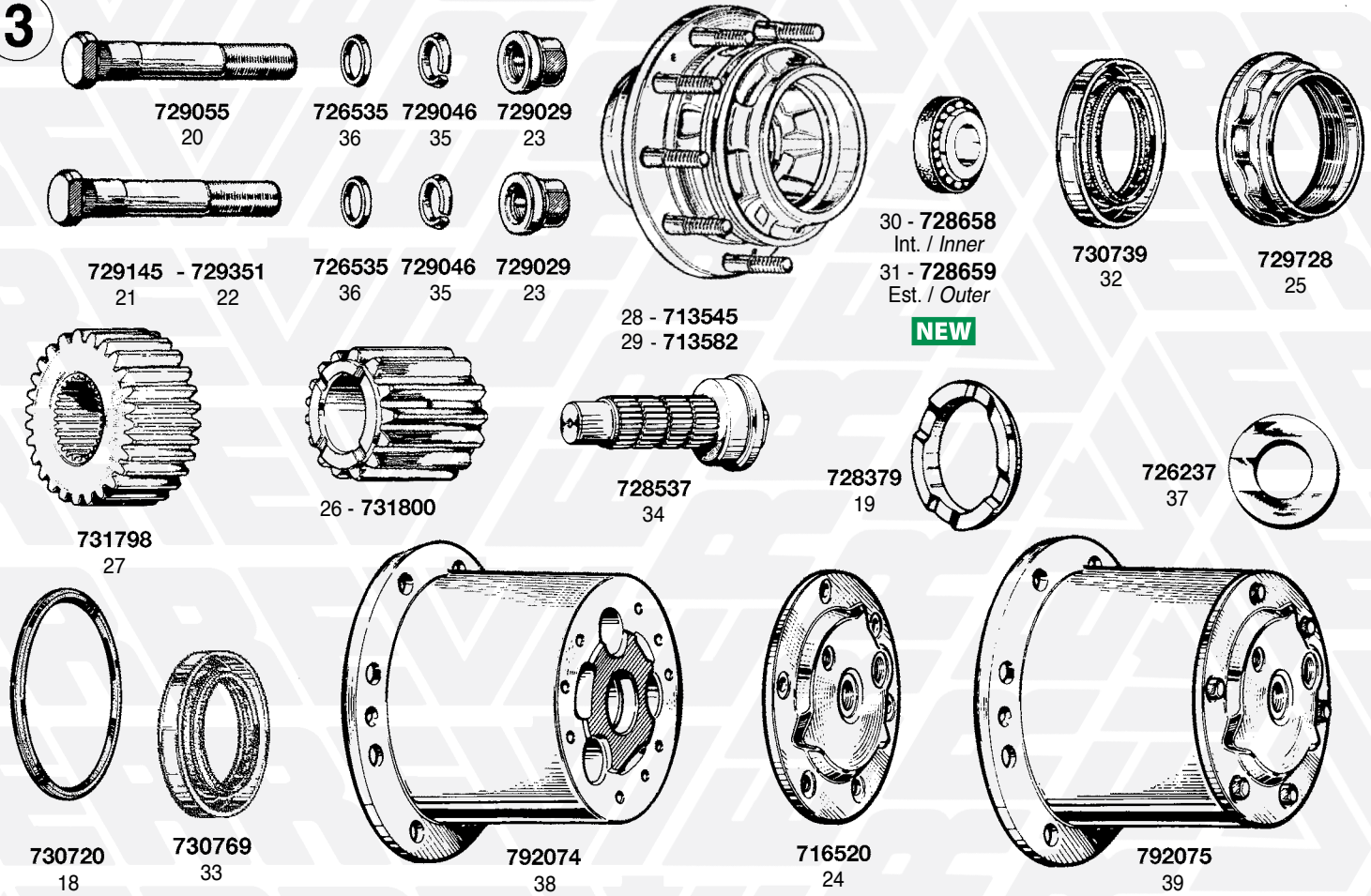

FIG. ITEM	RIF. ERREVI ERREVI REF.	DESCRIZIONE PARTICOLARI DESCRIPTION	TIPO VEHICLE MODEL	RIF. ORIG. ORIG. REF.
<div style="text-align: center;"> 1 330F26/ .26 - 330.30 - 330F35/ .35 - 330.36 GRUPPO DIFFERENZIALE / DIFFERENTIAL GROUP </div>				
1	720169	Perno portasatellite corto / <i>Pinion spindle</i>	∅ 27x75	42063134
2	720168	Perno portasatellite lungo / <i>Pinion spindle</i>	∅ 27x177	42063135
3	715009	Manicotto pignone (ponte intermedio) / <i>Pinion sleeve (middle axle)</i>	330F26/ F35	2968747
4	715008	Manicotto pignone (ponte intermedio) / <i>Pinion sleeve (middle axle)</i>	330.26/ .30/ .35	42494048
<div style="text-align: center;"> 2 MOZZI POSTERIORI CON RIDUTTORE (VEICOLI CON RAGGIERA) REAR AXLE EQUIPPED WITH TRANSFER CASE (VEHICLES WITH SPOKE WHEELS) </div>				
5	728379	Anello rasamento satellite / <i>Thrust washer</i>		42037800
6	716520	Coperchio per scatola riduttore / <i>Cover</i>		42062798 (ex 2476601)
7	728826	Bullone raggiera / <i>Wheel stud</i>	M20x2 L=115	42026106
8	729027	Dado per bullone raggiera / <i>Wheel nut</i>	M20x2	2478508
9	729728	Dado bloccaggio mozzo / <i>Nut</i>	M82x1,5	3555488
10	731798	Ingranaggio centrale riduttore / <i>Axle shaft gear</i>		4459828
11	731800	Ingranaggio satellite riduttore / <i>Step-down gear</i>		42159023 (ex 4459829)
12	730739	Paraolio esterno mozzo / <i>Oil seal, outer</i>	∅ 200x180x12	42037581
13	730769	Paraolio esterno mozzo in VITON / <i>Oil seal, outer (VITON material)</i>	∅ 200x180x12	40100673
14	728537	Perno portasatellite / <i>Saddle pin</i>		2477919
15	791026	Raggiera ruota / <i>Spoke wheel</i>		42037519 (ex 42026044)
16	726237	Rondella rasamento satellite / <i>Thrust washer</i>	∅ 29x51x1,3	2443705
17	728907	Tassello fissaggio ruota / <i>Wheel pad</i>		42014566
<div style="text-align: center;"> 3 MOZZI POSTERIORI CON RIDUTTORE (VEICOLI CON MOZZO) REAR AXLE EQUIPPED WITH TRANSFER CASE (VEHICLES WITH HUBS) </div>				
18	730720	Anello di tenuta per mozzo / <i>Oil seal</i>		42061628 (ex 42037594)
19	728379	Anello rasamento satellite / <i>Thrust washer</i>		42037800
20	729055	Colonna fiss. ruota 1ª Serie / <i>Wheel stud</i>	M22x1,5 L=111	42064826 42061641 42101367 (ex 42064826-42117455)
21	729145	Colonna fiss. ruota U.T. / <i>Wheel stud</i>	M22x1,5 L=101	42127220 42117453
22	729351	Colonna fiss. ruota (cerchi in lega) / <i>Wheel stud (Alloy rims)</i>	M22x1,5 L=128,5	-
23	729029	Dado per colonna fissaggio ruota / <i>Wheel nut</i>	M22x1,5	41800483
24	716520	Coperchio per scatola riduttore / <i>Cover</i>		42062798 (ex 2476601)
25	729728	Dado bloccaggio mozzo / <i>Nut</i>	M82x1,5	3555488
26	731800	Ingranaggio satellite riduttore / <i>Step-down gear</i>		42159023 (ex 4459829)
27	731798	Ingranaggio centrale riduttore / <i>Axle shaft gear</i>		4459828
28	713545	Mozzo ruota completa di colonnette U.T. / <i>Rear hub</i>		42101959 (ex 42037491)
29	713582	Mozzo ruota completa di colonnette U.T. / <i>Wheel hub c/w studs</i>		42101361
30	728658	Cuscinetto interno mozzo (VKHB2215) <i>Hub bearing, inner</i>	∅ 105x190x41,3	1102864 (ex 26800090)
31	728659	Cuscinetto esterno mozzo / <i>Hub bearing, outer (VKHB2216)</i>	∅ 120x180x38	1103360
32	730739	Paraolio esterno mozzo / <i>Oil seal, outer</i>	∅ 200x180x12	42037581
33	730769	Paraolio esterno mozzo in VITON / <i>Oil seal, outer (VITON material)</i>	∅ 200x180x12	40100673
34	728537	Perno portasatellite / <i>Saddle pin</i>		2477919
35	729046	Rondella spaccata per colonna / <i>Lockwasher</i>		504023611 (ex 1121811)
36	726535	Rondella conica per colonna / <i>Cone washer</i>		3420371
37	726237	Rondella rasamento satellite / <i>Thrust washer</i>	∅ 29x51x1,3	2443705
38	792074	Scatola riduttore U.T. / <i>Transfer case housing</i>		42037489
39	792075	Scatola riduttore completa di ingranaggi e coperchio U.T. <i>Transfer case assy</i>		-

**PONTE POST.
REAR AXLE**

1



729347
1



729626
2



3 - 729185
5 - 729348



729028
4 - 6



7 - 729187
8 - 729054



9 - 729629 CH 32 - H 31
10 - 729657 CH 32 - H 27



729349
11

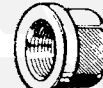

12 - 729629 CH 32 - H 31
13 - 729657 CH 32 - H 27

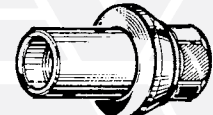

14 - 729803
15 - 729692

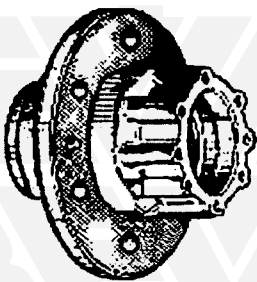

713625
17



728670
18

NEW

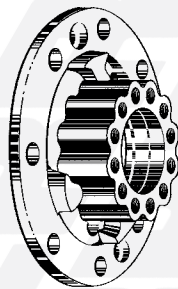

713630
19



728663
20

NEW

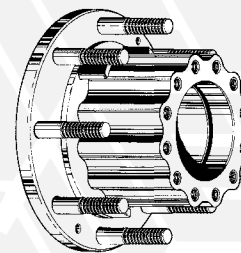

713637
21



22 - 728655
Int. / Inner
23 - 728656
Est. / Outer

NEW

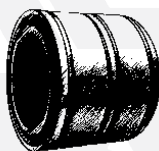

728711
16

NEW



730768
24



730765
25



727286
26

NEW

FIG. ITEM	RIF. ERREVI ERREVI REF.	DESCRIZIONE PARTICOLARI DESCRIPTION	TIPO VEHICLE MODEL	RIF. ORIG. ORIG. REF.	
1 EUROCARGO					
1	729347	Colonna fiss. ruota / <i>Wheel stud</i>	M18x1,5 L=75	60E10/E12/E14 - 65E10/E12/E14 75E12/E14/E15	42117465 7168333
2	729626	Dado per colonna / <i>Wheel nut</i>	M18x1,5	60E10/E12/E14 - 65E10/E12/E14 75E12/E14/E15	4459602 93805743 99474404
3	729185	Colonna fiss. ruota / <i>Wheel stud</i>	M20x1,5 L=77	80E15/E18/E21 - 100E15/E18/E21 120EL5/EL18/EL21 - 180E21T	42064829 7170510 42117435 42117434
4	729028	Dado per colonna / <i>Wheel nut</i>	M20x1,5	80E15/E18/E21 - 100E15/E18/E21 120EL5/EL18/EL21 - 180E21T	2476979 4803810 99474403
5	729348	Colonna fiss. ruota / <i>Wheel stud</i>	M20x1,5 L=90	120E15/E18/E23 130E15/E18/E23 - 260E23T	42117437 (ex 42064831)
6	729028	Dado per colonna / <i>Wheel nut</i>	M20x1,5	120E15/E18/E23 130E15/E18/E23 - 260E23T	2476979 4803810
7	729187	Colonna fiss. ruota 1ª Serie / <i>Wheel stud</i>	M22x1,5 L=89	150E15/E18/E23/E27 280E23 - 320E27	42064822 (ex 7168333)
8	729054	Colonna fiss. ruota U.T. / <i>Wheel stud</i>	M22x1,5 L=86	150E15/E18/E23/E27 280E23 - 320E27	42117451 42119444 42101338 2476077 7168580
9	729629	Dado per colonna 1ª Serie / <i>Wheel nut</i>	M22x1,5 H=31	150E15/E18/E23/E27-280E23-320E27	4459603
10	729657	Dado per colonna U.T. / <i>Wheel nut</i>	M22x1,5 H=27	150E15/E18/E23/E27 280E23 - 320E27	41036367 (ex 41031725)
11	729349	Colonna fiss. ruota / <i>Wheel stud</i>	M22x1,5 L=120	170E15/E18/E23/E27	42117457 42117309
12	729629	Dado per colonna 1ª Serie / <i>Wheel nut</i>	M22x1,5 H=31	170E15/E18/E23/E27	4459603
13	729657	Dado per colonna U.T. / <i>Wheel nut</i>	M22x1,5 H=27	170E15/E18/E23/E27	41036367 (ex 41031725)
14	729803	Dado con guida / <i>Wheel nut</i>	M22x1,5 H tot. 45 mm	170E15/E18/E23/E27	-
15	729692	Dado con guida / <i>Wheel nut</i>	M22x1,5 H tot. 62 mm	170E15/E18/E23/E27	41032669
16	728711	Kit cuscinetto completo / <i>Bearing assembly</i>	∅ 78x130x90	120EL15/EL18/EL21	7182915 (ex 7181863) (ex 7192915)
17	713625	Mozzo ruota nudo / <i>Wheel hub, bare</i>		60E10/E12/E14 - 65E10/E12/E14 75E12/E14/E15	7172993
18	728670	Cuscinetto interno ed esterno mozzo / <i>Hub bearing</i>	∅ 77,8x121,5x25,2	TURBO DAILY 59.12 DAILY CNG 59.11	1905220 VKHB2209
19	713630	Mozzo ruota nudo / <i>Wheel hub, bare</i>		80E15/E15H/E18/E21 - 85E18 95E18 - 100E15/E18/E21 - 180E21	7173696
20	728663	Cuscinetto interno ed esterno mozzo / <i>Hub bearing</i>	∅ 75x115x25	80E15/E15H/E18/E21 - 85E18 - 95E18 - 100E15/E18/E21 - 180E21	1905219 (ex 7173736 ex 7173737) VKHB2282
21	713637	Mozzo ruota completo di colonnette / <i>Wheel hub/w studs</i>		120E15/E15H/E18/E18H/E21H 120E23-130E15/E18/E23 - 150E18H 170E15/E18/E23 - 260E23	7172551
22	728655	Cuscinetto interno ed esterno mozzo / <i>Hub bearing</i>	∅ 85x150x38,5		1905172 (ex 7164544) VKHB2080
23	728656	Cuscinetto esterno mozzo / <i>Hub bearing, outer</i>	∅ 75x120x31		7166346 VKHB2137
24	730768	Paraolio esterno mozzo in VITON / <i>Oil seal, outer (VITON material)</i>	∅ 95x130x16		7185250 (ex 40102143)
25	730765	Paraolio esterno mozzo in VITON / <i>Oil seal, outer (VITON material)</i>	∅ 114x152x15	120E15/E15H/E18/E18H/E21H/E23 130E15/E18/E23 - 150E18 170E15/E18/E23 - 260E23	40102321
26	727286	Ruota fonica / <i>Impulse wheel</i>	∅ 110x118x101,5	60E10/E12/E14 - 65E10/E12/E14 75E12/E14/E15	7172753

**PONTE POST.
REAR AXLE**

1



729347
1



729626
2



3 - 729185
5 - 729348



729028
4 - 6

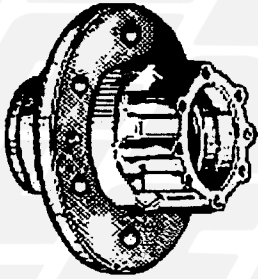

713625
7



728670
8

NEW

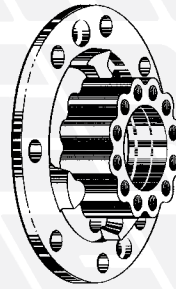

713630
9



728663
10

NEW

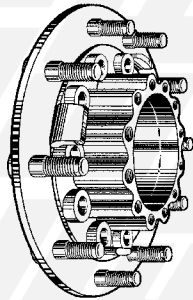

713631
11

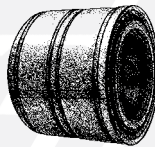

728710
12

NEW



730768
13

FIG. ITEM	RIF. ERREVI ERREVI REF.	DESCRIZIONE PARTICOLARI DESCRIPTION	TIPO VEHICLE MODEL	RIF. ORIG. ORIG. REF.
1 EUROCARGO "TECTOR"				
1	729347	Colonna fiss. ruota / <i>Wheel stud</i>	M18x1,5 L=75	75E13/E15/E17/E18 42117465 7168333
2	729626	Dado per colonna / <i>Wheel nut</i>	M18x1,5	75E13/E15/E17/E18 4459602
3	729185	Colonna fiss. ruota / <i>Wheel stud</i>	M20x1,5 L=77	100E17/E18/E21 - 120E17/E21 42064829 7170510 42117435 42117434
4	729028	Dado per colonna / <i>Wheel nut</i>	M20x1,5	100E17/E18/E21 - 120E17/E21 2476979 4803810 99474403
5	729348	Colonna fiss. ruota / <i>Wheel stud</i>	M20x1,5 L=90	100E18/E21 - 130E18/E24/E28 42064831 (ex 42117437)
6	729028	Dado per colonna / <i>Wheel nut</i>	M20x1,5	100E18/E21 - 130E18/E24/E28 2476979 4803810
7	713625	Mozzo ruota nudo / <i>Wheel hub, bare</i>		75E13/E15/E17/E18 7172993
8	728670	Cuscinetto interno ed esterno mozzo / <i>Hub bearing</i>	∅ 77,8x121,5x25,2	TURBO DAILY 59.12 DAILY CNG 59.11 1905220 VKHB2209
9	713630	Mozzo ruota nudo / <i>Wheel hub, bare</i>		100E17/E18/E21 7173696
10	728663	Cuscinetto interno ed esterno mozzo / <i>Hub bearing</i>	∅ 75x115x25	EUROCARGO 80E15/E15H/E18/E21 85E18 - 95E18 100E15/E18/E21 - 180E21 1905219 (ex 7173736 ex 7173737) VKHB2282
11	713631	Mozzo ruota completo di colonnette / <i>Wheel hub/w studs</i>		180E21/E24/E28 7179777 7186804
12	728710	Kit cuscinetto completo / <i>Bearing assembly</i>	∅ 90x160x125	2996882 (ex 7179751 - 7183074 - 7189050)
13	730768	Paraolio esterno mozzo in VITON / <i>Oil seal, outer (VITON material)</i>	∅ 95x130x16	7185250 (ex 40102143)

**PONTE POST.
REAR AXLE**

1



729054
1



2 - 729629 CH 32 - H 31
3 - 729657 CH 32 - H 27



729349
4

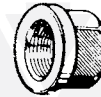

729657
5



729728
11



729145
6



729657
7

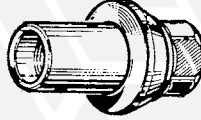

8 - 729803
9 - 729692



728733
10

NEW



727254
21

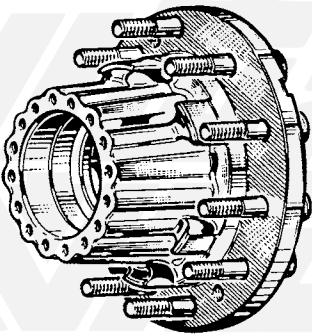

713596
12



13 - 728655 Est. / Outer
14 - 728662 Int. / Inner

NEW

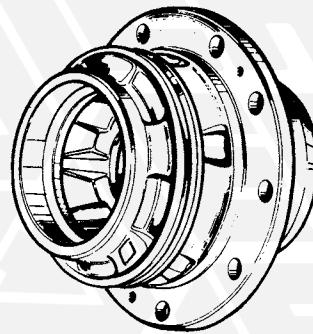

713508
15



16 - 728658 Int. / Inner
17 - 728659 Est. / Outer

NEW

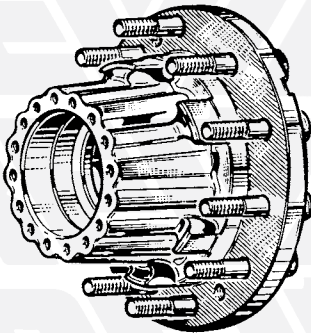

713518
18

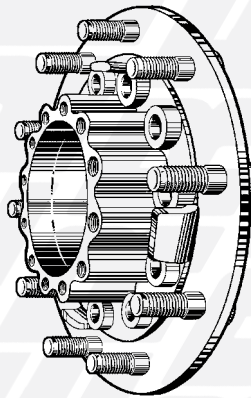

713631
20

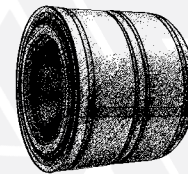

728710
19

FIG. ITEM	RIF. ERREVI ERREVI REF.	DESCRIZIONE PARTICOLARI DESCRIPTION		TIPO VEHICLE MODEL	RIF. ORIG. ORIG. REF.
<div style="display: flex; align-items: center;"> <div style="border: 1px solid black; border-radius: 50%; width: 30px; height: 30px; display: flex; align-items: center; justify-content: center; margin-right: 10px;"> 1 </div> <div> <p>EUROTECH - EUROTECH "CURSOR" EUROSTAR - EUROSTAR "CURSOR"</p> </div> </div>					
1	729054	Colonna fiss. ruota / <i>Wheel stud</i>	M22x1,5 L=86	EUROTECH "CURSOR"-EUROSTAR "CURSOR"	42117451 42119444 42101338 2476077 7168580
2	729629	Dado per colonna 1ª Serie / <i>Wheel nut</i>	M22x1,5 H=31	EUROTECH "Cursor"-EUROSTAR "Cursor"	4459603
3	729657	Dado per colonna U.T. / <i>Wheel nut</i>	M22x1,5 H=27	EUROTECH "CURSOR"-EUROSTAR "CURSOR"	41036367 41299921 (ex 41031725)
4	729349	Colonna fiss. ruota / <i>Wheel stud</i>	M22x1,5 L=120	EUROTECH-EUROSTAR 260E24/E31/E35/E39/E43 EUROTECH "CURSOR"	42117457 42117309
5	729657	Dado per colonna / <i>Wheel nut</i>	M22x1,5 H=27	EUROTECH -EUROSTAR 260E24/E31/E35/E39/E43 EUROTECH "CURSOR"	41036367 41299921 (ex 41031725)
6	729145	Colonna fiss. ruota / <i>Wheel stud</i>	M22x1,5 L=101	EUROTECH-EUROSTAR 260E24/E31/E35/E39/E43 EUROTECH "CURSOR"	42064824 42117453
7	729657	Dado per colonna / <i>Wheel nut</i>	M22x1,5 H=27	EUROTECH -EUROSTAR 260E24/E31/E35/E39/E43 EUROTECH "CURSOR"	41036367 41299921 (ex 41031725)
8	729803	Dado con guida / <i>Wheel nut</i>	M22x1,5 H tot. 45 mm		-
9	729692	Dado con guida / <i>Wheel nut</i>	M22x1,5 H tot. 62 mm		41032669 41036369
10	728733	Cuscinetto interno mozzo / <i>Hub bearing, inner</i>	ø 90x160x42,5	EUROTECH 240E38-400E38 EUROSTAR 180E38-240E38-400E38	1905353 7178975 26800240 32218A VKHB2030
11	729728	Dado bloccaggio mozzo / <i>Nut</i>	M82x1,5	190E42-440E42 EUROTECH 190E35-440E35/E39/E43 EUROTECH "CURSOR"	3555488
12	713596	Mozzo ruota completo di colonne / <i>Wheel hub c/w studs (senza ruota fonica e parapolvere)</i>		EUROTECH-EUROSTAR	7179929 7181782 42551227
13	728655	Cuscinetto interno ed esterno mozzo / <i>Hub bearing</i>	ø 85x150 x38,5		1905172 (ex 7164544) VKHB2080
14	728662	Cuscinetto interno mozzo / <i>Hub bearing, inner</i>	ø 105x190x53	EUROTECH - EUROSTAR	7177004 (ex 26800270) VKHB2212
15	713508	Mozzo ruota / <i>Rear hub</i>		190E42-440E42 EUROTECH 190E35-440E35 EUROTECH "CURSOR"	42104691
16	728658	Cuscinetto interno mozzo / <i>Hub bearing, inner</i>	ø 105x190x41,3	EUROTECH 190E42 - 440E42 EUROTECH "Cursor" 190/440E35	1102864 (ex 26800090) VKHB2215
17	728659	Cuscinetto esterno mozzo / <i>Hub bearing, outer</i>	ø 120x180x38	EUROTECH 190E42 - 440E42 EUROTECH "Cursor" 190/440E35	1103360 VKHB2216
18	713518	Mozzo ruota completo di colonne / <i>Wheel hubc/w studs</i>			7180909
19	728710	Kit cuscinetto completo / <i>Bearing assembly</i>	ø 90x160x125		2996882 (ex 7179751 7183074 7189050)
20	713631	Mozzo ruota completo di colonne / <i>Wheel hubc/w studs</i>		EUROTECH "Cursor" - EUROSTAR "Cursor"	7179777 7186804
21	727254	Ruota fonica / <i>Impulse wheel</i>	ø 202x218x24	EUROTECH - EUROTECH "Cursor" EUROSTAR	7166885

1



729054
1



2 - 729629 CH 32 - H 31
3 - 729657 CH 32 - H 27



729055
4

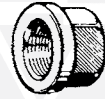

729657
5



726237
21



729351
6

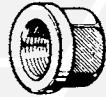

7 - 729629 CH 32 - H 31
8 - 729657 CH 32 - H 27

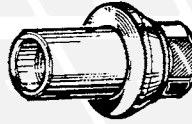

9 - 729803
10 - 729692

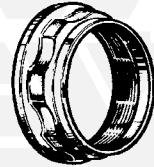

729728
12



727254
22

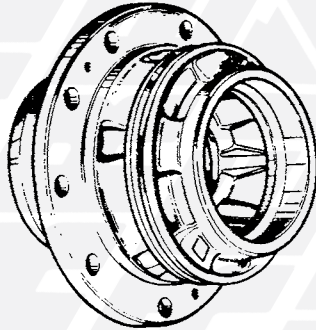

713508
15



16 - 728658 Int. / Inner
17 - 728659 Est. / Outer

NEW



730757
18

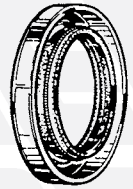

730739
19

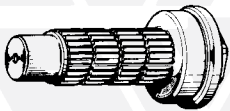

20 - 728544

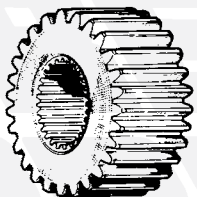

13 - 731851

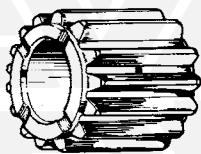

14 - 731850

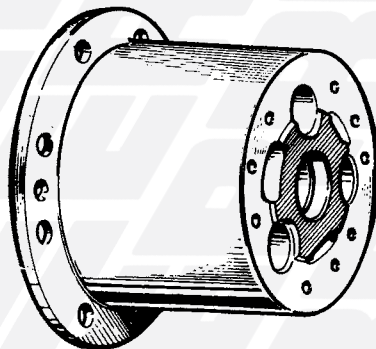

792076
23

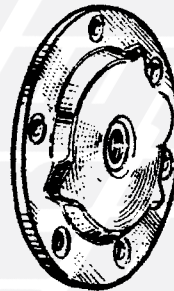

716521
11

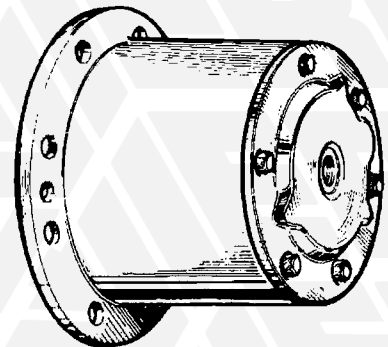

792077
24

FIG. ITEM	RIF. ERREVI ERREVI REF.	DESCRIZIONE PARTICOLARI DESCRIPTION	TIPO VEHICLE MODEL	RIF. ORIG. ORIG. REF.	
<div style="display: flex; align-items: center; justify-content: center;"> <div style="border: 1px solid black; border-radius: 50%; width: 30px; height: 30px; display: flex; align-items: center; justify-content: center; margin-right: 10px;">1</div> <div> EUOTRAKKER - EUOTRAKKER "CURSOR" </div> </div>					
1	729054	Colonna fiss. ruota / <i>Wheel stud</i>	M22x1,5 L=86	340E42-410E42 EUOTRAKKER EUOTRAKKER "CURSOR"	42117451 42119444 42101338 2476077 7168580
2	729629	Dado per colonna 1ª Serie / <i>Wheel nut</i>	M22x1,5 H=31	340E42-410E42 EUOTRAKKER EUOTRAKKER "CURSOR"	4459603
3	729657	Dado per colonna U.T. / <i>Wheel nut</i>	M22x1,5 H=27	340E42-410E42 EUOTRAKKER EUOTRAKKER "CURSOR"	41036367 41299921 (ex 41031725)
4	729055	Colonna fiss. ruota / <i>Wheel stud</i>	M22x1,5 L=111	EUOTRAKKER 180E24/E27 EUOTRAKKER } 190E24/E27/E38 } "CURSOR"	42064826 42127249 42061641 42101367 (ex 42117455)
5	729657	Dado per colonna / <i>Wheel nut</i>	M22x1,5 H=27	EUOTRAKKER 180E24/E27 EUOTRAKKER } 190E24/E27/E38 } "CURSOR"	41036367 41299921 (ex 41031725)
6	729351	Colonna fiss. ruota (cerchi in lega) / <i>Wheel stud (Alloy rims)</i>	M22x1,5 L=128,5	EUOTRAKKER	-
7	729629	Dado per colonna 1ª Serie / <i>Wheel nut</i>	M22x1,5 H=31	EUOTRAKKER	4459603
8	729657	Dado per colonna / <i>Wheel nut</i>	M22x1,5 H=27	EUOTRAKKER	41036367 (ex 41031725)
9	729803	Dado con guida / <i>Wheel nut</i>	M22x1,5 H TOT. 45	EUOTRAKKER "CURSOR"	-
10	729692	Dado con guida / <i>Wheel nut</i>	M22x1,5 H TOT. 62	EUOTRAKKER "CURSOR"	41036369
11	716521	Coperchio scatola riduttore / <i>Cover</i>			42118921
12	729728	Dado bloccaggio mozzo / <i>Nut</i>	M82x1,5		3555488
13	731851	Ingranaggio centrale riduttore / <i>Axle shaft gear</i>	Z=30		42064799
14	731850	Ingranaggio satellite riduttore / <i>Step-down gear</i>	Z=17		42064798
15	713508	Mozzo ruota / <i>Rear hub</i>			42104691
16	728658	Cuscinetto interno mozzo / <i>Hub bearing, inner</i>	ø 105x190x41,3		1102864 (ex 26800090) VKHB2215
17	728659	Cuscinetto esterno mozzo / <i>Hub bearing, outer</i>	ø 120x180x38		1103360 VKHB2216
18	730757	Paraolio interno mozzo / <i>Oil seal, inner</i>	ø180x200x12	380E37 - 410E42 - 720E37/E42 EUOTRAKKER 190E31/E35 - 380E38/E48 } EUOTRAKKER 410E38/E44 - 720E38 } "CURSOR"	42127526 (ex 40100443)
19	730739	Paraolio esterno mozzo / <i>Oil seal, outer</i>	ø 200x180x12		42037581
20	728544	Perno portasatellite / <i>Saddle pin</i>			42064785
21	726237	Rondella rasamento satellite / <i>Thrust washer</i>	ø 29x51x1,3		2443705
22	727254	Ruota fonica / <i>Impulse wheel</i>	ø 202x218x24		7166885
23	792076	Scatola riduttore / <i>Transfer case housing</i>			42118227
24	792077	Scatola riduttore compl. di ingranaggi e coperchio / <i>Transfer case assy</i>			-

**PONTE POST.
REAR AXLE**

1



729054
1



2 - 729629 CH 32 - H 31
3 - 729657 CH 32 - H 27

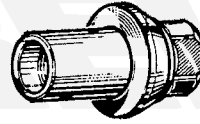

4 - 729803
5 - 729692



729177
6



7 - 729629 H 31
8 - 729657 H 27



729741
9

NEW

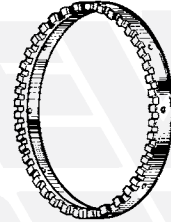

727254
13

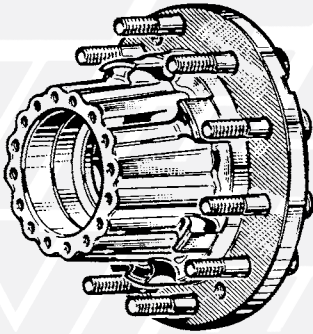

713518
10

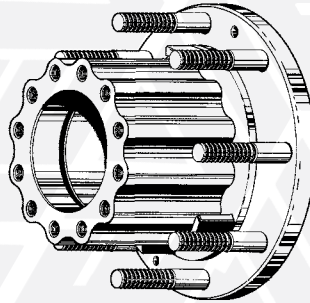

713631
12

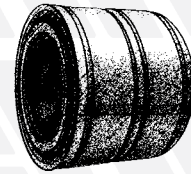

728710
11

FIG. ITEM	RIF. ERREVI ERREVI REF.	DESCRIZIONE PARTICOLARI DESCRIPTION	TIPO VEHICLE MODEL	RIF. ORIG. ORIG. REF.
1 STRALIS				
1	729054	Colonna fiss. ruota / <i>Wheel stud</i>	M22x1,5 L=86 260S40/S43	42117451 42119444 42101338 2476077 7168580
2	729629	Dado per colonna 1ª Serie / <i>Wheel nut</i>	M22x1,5 H=31 260S40/S43	4459603
3	729657	Dado per colonna / <i>Wheel nut</i>	M22x1,5 H=27 260S40/S43	41036367 41299921 (ex 41031725)
4	729803	Dado con guida / <i>Wheel nut</i>	M22x1,5 H tot. 45 190S43/S48- 260S40/S43/S48/S54 - 440S40/S43/S48/S54	-
5	729692	Dado con guida / <i>Wheel nut</i>	M22x1,5 H tot. 62 190S43/S48 - 260S40/S43/S48/S54 440S40/S43/S48/S54	41036369
6	729177	Colonna fiss. ruota / <i>Wheel stud</i>	M22x1,5 L=77 260S40/S43/S44/S48/S54 440S40/S43/S44/S48/S54	42117448 42116737 (ex 42064821)
7	729629	Dado per colonna / <i>Wheel nut</i>	M22x1,5 H=31 260S40/S43/S44/S48/S54 440S40/S43/S44/S48/S54	4459603
8	729657	Dado per colonna / <i>Wheel nut</i>	M22x1,5 H=27 260S40/S43/S44/S48/S54 440S40/S43/S44/S48/S54	41036367 41299921 (ex 41031725)
9	729741	Dado bloccaggio mozzo / <i>Wheel nut</i>	M88x2 190S36 - 260S36 - 440S45/S50	7184036 (ex 7179746)
10	713518	Mozzo ruota completo di colonne / <i>Wheel hub c/w studs</i>		7180909
11	728710	Kit cuscinetto completo / <i>Bearing assembly</i>	ø 90x160x125	2996882 (ex 7179751 -7183074 - 7189050)
12	713631	Mozzo ruota completo di colonne / <i>Wheel hub c/w studs</i>		7179777 7186804
13	727254	Ruota fonica / <i>Impulse wheel</i>	ø 202x218x24	7166885

**PONTE POST.
REAR AXLE**

1



729389
4

NEW



729390
5

NEW

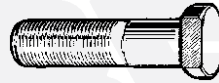

729391
6

NEW



729392
7

NEW



729029
2



729046
3



729182
1



729830
9

NEW



729831
8

NEW



729832
10

NEW



729785
11

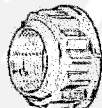

729786
17

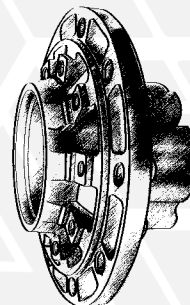

19 - 713782 Nudo / Bare

NEW

20 - 713796 Compl. / Assembly



728709
21



728720
22

NEW



12 - 728721

13 - 728722

14 - 728727

15 - 728728

16 - 728729

NEW

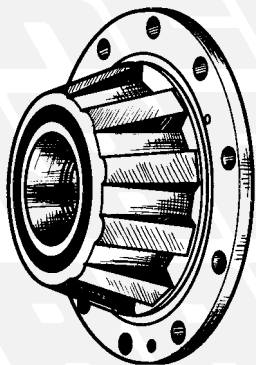

713916
23

NEW



729777
24

NEW



729778
25

NEW



728711
18

NEW



730774
26

NEW



730785
27

NEW

FIG. ITEM	RIF. ERREVI ERREVI REF.	DESCRIZIONE PARTICOLARI DESCRIPTION		TIPO VEHICLE MODEL	RIF. ORIG. ORIG. REF.
1 MAN					
1	729182	Colonna fissaggio ruota / <i>Wheel stud</i>	M22x1,5 L=110	F2000 - F90	81455010067 81455010082 81455010141
2	729029	Dado per colonna / <i>Wheel nut</i>	M22x1,5		41800483
3	729046	Rondella spaccata per colonna / <i>Lockwasher</i>			504023611 (ex 1121811)
4	729389	Colonna fissaggio ruota / <i>Wheel stud</i>	M18x1,5 L=58	TGL	81455010152 81455010116
5	729390	Colonna fissaggio ruota / <i>Wheel stud</i>	M18x1,5 L=70	TGL	81455010171
6	729391	Colonna fissaggio ruota / <i>Wheel stud</i>	M18x1,5 L=70	L2000	81455010181
7	729392	Colonna fissaggio ruota / <i>Wheel stud</i>	M18x1,5 L=70	L2000	81455010159
8	729831	Colonna fissaggio ruota / <i>Wheel stud</i>	M22x1,5 L=65	E2000 - F2000 - M2000 TGA TGM - TGS - TGX	81455010129
9	729830	Colonna fissaggio ruota / <i>Wheel stud</i>	M22x1,5 L=80	L2000 - M2000 - TGA - TGM TGS - TGX	81455010114 81455010133 81455010163 81455010164 81455010174
10	729832	Colonna fissaggio ruota / <i>Wheel stud</i>	M22x1,5 L=110	F2000 - TGA - TGM - TGS - TGX	81455010176 81455010131
11	729785	Dado di fiss. manicotto pignone conico / <i>Pinion nut</i>	M45x1,5	F90 - G90 - M90 TGM - TGL - TGX - TGA - TGS	81906400032 81906850311
12	728721	Cuscinetto esterno mozzo (30220A, VKHB2164) <i>Hub bearing, outer</i>	ø 100x180x37	F90 - E2000 - F2000 - M2000 - TGA	06324890032 06324890095 64934200023 64934200024 64934200065 81934200090
13	728722	Cuscinetto interno ed esterno mozzo (32018XA, VKHB2170) <i>Hub bearing</i>	ø 90x140x32	L2000 - M2000 - M90	06324890011 06324890051
14	728727	Cuscinetto interno mozzo (33021, VKHB2162) <i>Hub bearing, inner</i>	ø 105x160x43	TGA - TGS - TGX	06324990096 06324990127 06324990183 06324990188
15	728728	Cuscinetto interno mozzo (33022, VKHB2163) <i>Hub bearing, inner</i>	ø 110x170x47	F2000 - M2000 - F90 - M90 E2000 - TGA - TGM - TGX	06324990044 06324990045 06324990155 06324990156
16	728729	Cuscinetto esterno mozzo (33115, VKHB2222) <i>Hub bearing, outer</i>	ø 75x125x37	L2000 - M2000 - M90 - E2000 F2000 - F90 - TGA	06324990040 06324990131 06324990189 81934200270
17	729786	Dado di fiss. manicotto pignone conico / <i>Pinion nut</i>	M55x1,5	F90 - G90 - M90 TGM - TGL - TGX - TGA - TGS	81906850303 81906850052
18	728711	Kit cuscinetto completo / <i>Bearing assembly</i>	ø 78x130x90	L2000 - TGL - TGM	81934200336 81934200379 81934206083 81934206099
19	713782	Mozzo ruota, nudo / <i>Wheel hub, bare</i>		TGM - TGX - TGA - TGS (per freno a disco)	81357010155
20	713796	Mozzo ruota completo / <i>Wheel hub assembly</i>		TGM - TGX - TGA - TGS (per freni a disco) (<i>for brake disc</i>)	813570101555
21	728709	Kit cuscinetto completo / <i>Bearing assembly</i>	ø 105x160x140	TGM - TGX - TGA - TGS	81934200342 81934200320 81934200376
22	728720	Kit cuscinetto completo / <i>Bearing assembly</i>	ø 110x170x146	F2000-TGA-TGS-TGX	81934200346 81934200377 81934206098
23	713916	Mozzo ruota completo / <i>Wheel hub assembly</i>		TGA - TGS - TGX	81357006150 81357006136
24	729777	Ghiera fissaggio mozzo / <i>Axle locking nut</i>	M100x1,5 L=17	TGA	81906200092
25	729778	Ghiera fissaggio mozzo / <i>Axle locking nut</i>	M42x1,5 L=18	TGL	81906200098
26	730774	Paraolio mozzo con ABS / <i>Oil seal c/w ABS</i>	ø 135x175x16	F90 - F2000	81965030188 81965030398 81965030207
27	730785	Paraolio interno mozzo / <i>Oil seal, inner</i>	ø 144x175x14	TGA - TGS - TGX - F2000 M90 - L2000 - F90 - G90 - M2000	06562890371

1

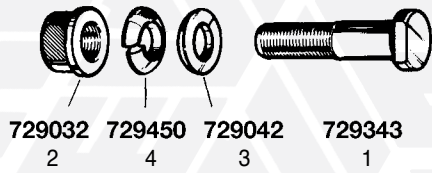

8 - 729374 L=68
9 - 729369 L=80
10 - 729364 L=90
11 - 729375 L=110

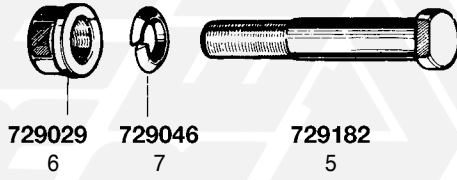

13 - 728721
14 - 728722
15 - 728723
16 - 728724
17 - 728727
18 - 728728
19 - 728729
20 - 728733

NEW



729785
21



729786
22



730785
23

NEW



727267
24

NEW

2



729394
25

NEW

FIG. ITEM	RIF. ERREVI ERREVI REF.	DESCRIZIONE PARTICOLARI DESCRIPTION		TIPO VEHICLE MODEL	RIF. ORIG. ORIG. REF.
1 MERCEDES					
1	729343	Colonna fissaggio ruota / <i>Wheel stud</i>	M20x1,5 L=72	811 - 813 - 913 - 1113 - 1213	3524020171 (ex 3124021071)
2	729032	Dado per colonna / <i>Wheel nut</i>	M20x1,5	811 - 813 - 913 - 1113 - 1213	74361020205 (ex 074361020204)
3	729042	Rondella conica per colonna / <i>Cone washer</i>		811 - 813 - 913 - 1113 - 1213	664020075
4	729450	Rondella spaccata per colonna / <i>Lockwasher</i>		811 - 813 - 913 - 1113 - 1213	74361020352
5	729182	Colonna fissaggio ruota / <i>Wheel stud</i>	M22x1,5 L=110	1222-1622-1932-2626-3250-3535	3464010071 3814010771
6	729029	Dado per colonna / <i>Wheel nut</i>	M22x1,5	1222-1622-1932-2626-3250-3535	3854000124 (ex 6174000024)
7	729046	Rondella spaccata per colonna / <i>Lockwasher</i>		1222-1622-1932-2626-3250-3535	74361022351
8	729374	Colonna fissaggio ruota / <i>Wheel stud</i>	M22x1.5 L=68	ACTROS - ATEGO	9424010271
9	729369	Colonna fissaggio ruote / <i>Wheel stud</i>	M22x1.5 L=80	ATEGO - ACTROS	-
10	729364	Colonna fissaggio ruota / <i>Wheel stud</i>	M22x1.5 L=90	ACTROS - ATEGO	9424010371
11	729375	Colonna fissaggio ruota / <i>Wheel stud</i>	M22x1,5 L=110	ACTROS - ATEGO	3814010771
12	729659	Dado per colonna / <i>Wheel nut</i>	M22x1.5	ACTROS - ATEGO	0004010672
13	728721	Cuscinetto esterno mozzo (30220A, VKHB2164) <i>Hub bearing, outer</i>	ø 100x180x37	Serie MK - SK - NG	0049812105 0049814905 0079810005
14	728722	Cuscinetto mozzo (32018XA, VKHB2170) <i>Hub bearing</i>	ø 90x140x32	ATEGO - ATEGO2 - ATEGO3	0049811705 0049814305 0059815605 0069810005
15	728723	Cuscinetto esterno mozzo (32019XA, VKHB2161) <i>Hub bearing, outer</i>	ø 95x145x32	Serie MK - SK - NG ACTROS - ACTROS MP2	0019802602 0029815405 0039815105 0069814705
16	728724	Cuscinetto mozzo (32019XA, VKHB2161) <i>Hub bearing</i>	ø 100x150x32	ACTROS - ATEGO - AXOR - AXOR 2 ACTROS MP2	0019802602 0029815405 0039815105 0069814705
17	728727	Cuscinetto interno mozzo (3302, VKHB2162) <i>Hub bearing, inner</i>	ø 105x160x43	ACTROS - ATEGO - AXOR - AXOR 2 ACTROS MP2	0009809702 0039812605 0039812805 0059814905
18	728728	Cuscinetto interno mozzo (33022, VKHB2163) <i>Hub bearing, inner</i>	ø 110x170x47	ACTROS - ATEGO - AXOR - AXOR 2 ACTROS MP2 - ACTROS MP4	0049810705 0049810905 0059812105 0089813505 0189817105
19	728729	Cuscinetto mozzo (33115, VKHB2222) <i>Hub bearing</i>	ø 75x125x37	ACTROS - ATEGO - AXOR - AXOR 2 ACTROS MP2	0009814218 0039813005 0039813205 0089810305
20	728733	Cuscinetto mozzo (32218A, VKHB2030) <i>Hub bearing</i>	ø 90x160x42,5		000720032218
21	729785	Dado di fiss. manicotto pignone conico / <i>Pinion nut</i>	M45x1,5	ACTROS	3663530072 3853510672
22	729786	Dado di fiss. manicotto pignone conico / <i>Pinion nut</i>	M55x1,5		3463530072 3853510572
23	730785	Paraolio interno mozzo / <i>Oil seal, inner</i>	ø 144x175x14	ACTROS - ACTROS MP2 - ATEGO	0159974947
24	727267	Ruota fonica / <i>Impulse wheel</i>	ø 153x176x16 100 denti/ <i>teeth</i>	ATEGO - AXOR - AXOR 2 - ACTROS ACTROS MP2	9423560715 9423560315 9423560015
2 NISSAN					
25	729394	Colonna fissaggio ruota / <i>Wheel stud</i>	M16x1,5 L=59	CABSTAR 110-120	402229X50B (ex 43222F3600)

1

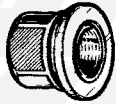

729624
5



729175
1



729387
4

NEW



729393
2

NEW



729395
3

NEW

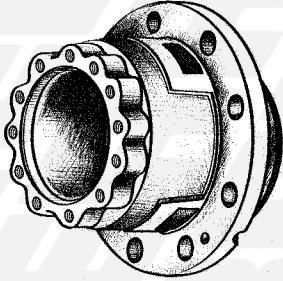

713780
10



11 - 728708 Est. / Outer
12 - 728707 Int. / Inner

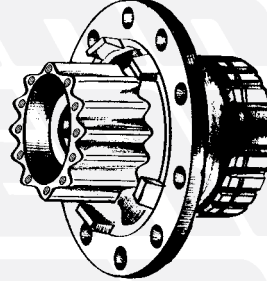

713776
13

NEW

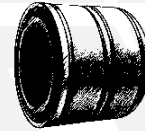

728706
14

NEW



729773
6

NEW

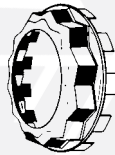

726374
19

NEW



7 - 728723
8 - 728725
9 - 728727

NEW

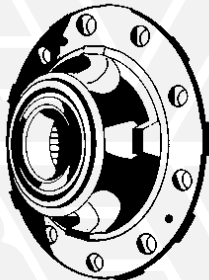

15 - 713901 Nudo / Bare
16 - 713902 Compl. / Assembly

NEW

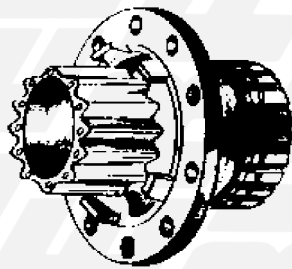

713917
18

NEW

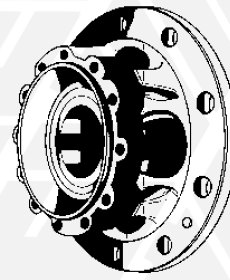

713799
17

NEW

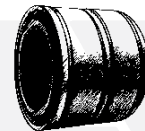

728706
14

NEW



727290
20

NEW

FIG. ITEM	RIF. ERREVI ERREVI REF.	DESCRIZIONE PARTICOLARI DESCRIPTION		TIPO VEHICLE MODEL	RIF. ORIG. ORIG. REF.
<div style="display: flex; align-items: center; justify-content: center;"> <div style="border: 1px solid black; border-radius: 50%; width: 30px; height: 30px; display: flex; align-items: center; justify-content: center; margin-right: 10px;">1</div> <h1 style="margin: 0;">RENAULT</h1> </div>					
1	729175	Colonna fissaggio ruota / <i>Wheel stud</i>	M22x1,5 L=95	Gamma G.R. (veicoli pesanti)	0000190220 5010097347 5010457733 7420551045
2	729393	Colonna fissaggio ruota / <i>Wheel stud</i>	M22x1,5 L=79	MAGNUM - PREMIUM	7420515514
3	729395	Colonna fissaggio ruota / <i>Wheel stud</i>	M22x1,5 L=105	MAGNUM - PREMIUM - KERAX	7420515519
4	729387	Colonna fissaggio ruota / <i>Wheel stud</i>	M22x1,5 L=114	MAGNUM - PREMIUM - KERAX	7420524942 7421147687
5	729624	Dado per colonna / <i>Wheel nut</i>	M22x1,5	Gamma G.R. (veicoli pesanti)	5010262935 5010439317 5010439406 (ex 21323312 - 21623013)
6	729773	Ghiera fissaggio mozzo / <i>Axle locking nut</i>	M8x2	MAGNUM - PREMIUM	7401076335
7	728723	Cuscinetto interno mozzo / <i>Hub bearing, inner</i>	ø 95x145x32	KERAX - MAGNUM - MAXTER MIDLINER - MIDLUM - PREMIUM	5010241096 5010439224 5010534822 5010587011 32019XA VKHB2161
8	728725	Cuscinetto interno ed esterno mozzo / <i>Hub bearing</i>	ø 110x170x38	MIDLINER (6 x 6)	5001014916 5000021895 VKHB2281 32022X
9	728727	Cuscinetto interno mozzo / <i>Hub bearing, inner</i>	ø 105x160x43		5010319057 5010443791 5010443751 33021 VKHB2162
10	713780	Mozzo ruota, nudo / <i>Wheel hub, bare</i>		PREMIUM MAGNUM KERAX	5010566112
11	728708	Cuscinetto esterno mozzo / <i>Outer bearing</i>	ø 95x150x42	PREMIUM MAGNUM KERAX	5010587009
12	728707	Cuscinetto interno mozzo / <i>Inner bearing</i>	ø 95x160x46	PREMIUM MAGNUM KERAX	5010587010
13	713776	Mozzo ruota completo / <i>Wheel hub assembly</i>		MAGNUM - PREMIUM (per freno a disco) / (for brake disc)	7420535263 7485107753
14	728706	Kit cuscinetto completo / <i>Bearing assembly</i>	ø 94x148x135	KERAX - PREMIUM - PREMIUM 2 MAGNUM DXi	7420518661 7420792439 7421036050
15	713901	Mozzo ruota nudo / <i>Wheel hub, bare</i>		PREMIUM - KERAX	7421328181 7420820402
16	713902	Mozzo ruota completo / <i>Wheel hub assembly</i>		PREMIUM - KERAX	7421328181S 7420820402S
17	713799	Mozzo ruota completo / <i>Wheel hub assembly</i>		PREMIUM - KERAX	7420819822 7420820420
18	713917	Mozzo ruota nudo / <i>Wheel hub, bare</i>		PREMIUM - MAGNUM	7420516957
19	726374	Rondella di bloccaggio dado assale / <i>Lock washer</i>		MAGNUM - PREMIUM	7408157714
20	727290	Ruota fonica / <i>Impulse wheel</i>	ø 140x164x7 100 denti / <i>teeth</i>	PREMIUM - MAGNUM - KERAX	7420424109

**PONTE POST.
REAR AXLE**

1



729047
6



729274
7



729268
5

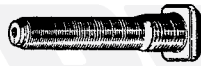

1 - 729162
2 - 729163



3 - 729397
4 - 729833

NEW

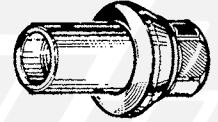

8 - 729808
9 - 729809
10 - 729810
11 - 729811

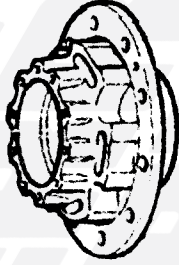

713753
19



728641
23

NEW



12 - 728725
13 - 728726
14 - 728727
15 - 728731
16 - 728733

NEW



729787
17

NEW

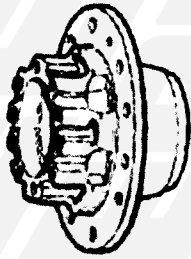

713751
20



728641
23

NEW



730771
24

NEW



730773
25

NEW



727268
26

NEW

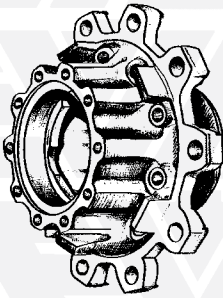

713774
21



728641
23

NEW



728641
23

NEW

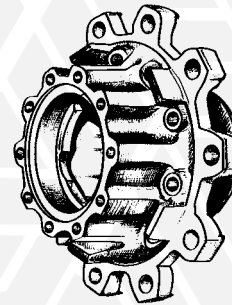

713798
18

NEW



728641
23

NEW

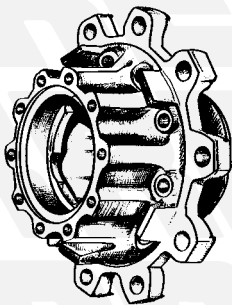

713794
22

NEW



728641
23

NEW

FIG. ITEM	RIF. ERREVI ERREVI REF.	DESCRIZIONE PARTICOLARI DESCRIPTION		TIPO VEHICLE MODEL	RIF. ORIG. ORIG. REF.
1 SCANIA					
1	729162	Colonna posteriore / <i>Wheel stud</i>	7/8"Dx L=85	81 - 86 - 110 - 111 - 112 - 141 142 - 143	295953 1368693
2	729163	Colonna posteriore / <i>Wheel stud</i>	7/8"Dx L=100	110 - 111 - 112 - 142 143 (4x2 - 6x2 - 6x4)	272853 1368694
3	729397	Colonna fissaggio ruota / <i>Wheel stud</i>	7/8"-11BSF L=85	Serie P - G - R - T Series 94 - 114 - 124	2285279 1528712
4	729833	Colonna fissaggio ruota / <i>Wheel stud</i>	7/8"-11BSF L=105	Serie P - G - R - T Series Serie 4 Series	1528655
5	729268	Dado / <i>Wheel nut</i>	7/8"Dx H=26		318690 1365510 1749034 (ex 243956)
6	729047	Dado per bullone raggiera c/battuta / <i>Wheel nut</i> Ruote posteriori (veicoli con mozzi) / <i>Rear wheels (with spoke wheels)</i>	M18x2		265447 (ex 130961)
7	729274	Controdado / <i>Locknut</i> Ruote posteriori (veicoli con mozzi) / <i>Rear wheels (with spoke wheels)</i>	7/8"Dx H=16		121306
8	729808	Dado con guida / <i>Wheel nut</i>	7/8"-11 BSF H tot. 44		-
9	729809	Dado con guida / <i>Wheel nut</i>	7/8"-11 BSF H tot. 50		-
10	729810	Dado con guida / <i>Wheel nut</i>	7/8"-11 BSF H tot. 56		-
11	729811	Dado con guida / <i>Wheel nut</i>	7/8"-11 BSF H tot. 78		-
12	728725	Cuscinetto esterno mozzo / <i>Hub bearing, outer (VKHB2281)</i>	ø 110x170x38	82 - 92 - 112 - 142 - 93 - 113 - 143	351715 264960 362226 32022X
13	728726	Cuscinetto esterno mozzo/ <i>Hub bearing, outer (VKHB2004)</i>	ø 45x100x38,25	82 - 92 - 112 - 142 - 93 - 113 - 143	397314 1362149 014623 32309A
14	728727	Cuscinetto interno mozzo / <i>Hub bearing, inner (VKHB2162)</i>	ø 105x160x43	82 - 92 - 112 - 142 - 93 - 113 - 143	351713 33021
15	728731	Cuscinetto interno ed esterno mozzo / <i>Hub bearing (VKHB2032)</i>	ø 100x157x42	82 - 92 - 112 - 142 93 - 113 - 143	354076 272716 KHM220149.220.110
16	728733	Cuscinetto interno ed esterno mozzo / <i>Hub bearing (VKHB2030)</i>	ø 90x160x42,5	82 - 92 - 112 - 142 93 - 113 - 143	14835 32218A
17	729787	Ghiera fissaggio mozzo / <i>Grooved nut</i>	M60x2	94 - 114 - 124 - 144	1356196 1403618 1873183
18	713798	Mozzo ruota completo / <i>Wheel hub assembly</i>		94 - 114 - 124 - 144 - 164 (per freno a disco) / (for brake disc)	17247905
19	713753	Mozzo ruota, nudo / <i>Wheel hub, bare</i>		93 - 113 - 143 94 - 114 - 124 - 144 - 164	255348 337565 347945 1724788
20	713751	Mozzo ruota, nudo / <i>Wheel hub, bare</i>		94 - 114 - 124 - 144 - 164 (per freno a disco) / (for brake disc)	1382884
21	713774	Mozzo ruota, nudo / <i>Wheel hub, bare</i>		94 - 114 - 124 - 144 - 164 (per freno a disco) / (for brake disc)	1724790
22	713794	Mozzo ruota nudo / <i>Wheel hub, bare</i>		94 - 114 - 124 - 144 - 164	1800283
23	728641	Cuscinetto int./est. mozzo / <i>Hub bearing</i>	ø 90x147x42	93 - 113 - 143 94 - 114 - 124 - 144 - 164	1524625
24	730771	Paraolio mozzo / <i>Oil seal, rear</i>	ø 158x188x16	93 - 113 - 143 - 114 - 124 - 144	1309342 1363674 1528043 1786639 1907845 528043
25	730773	Paraolio mozzo / <i>Oil seal</i>	ø 143,5x170x20	93 - 113 - 143 - 114 - 124 - 144	291076 370076 120310
26	727268	Ruota fonica / <i>Impulse wheel</i>	ø 126x164x8,5 100 denti / <i>teeth</i>	Serie 3 - 4 Series	1339680 1375382

1



729624

4

NEW



- 1 - 729393 L=79
- 2 - 729395 L=105
- 3 - 729387 L=114

NEW

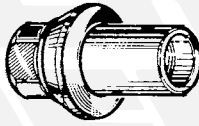

- 8 - 729804
- 9 - 729805
- 10 - 729806
- 11 - 729807



729258

7



- 5 - 729156
- 6 - 729198 con riduttore

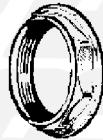

729775

13

NEW



729773

14

NEW



726374

15

NEW

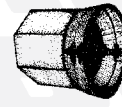

732741

12

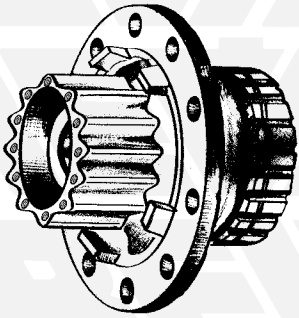

713776

16

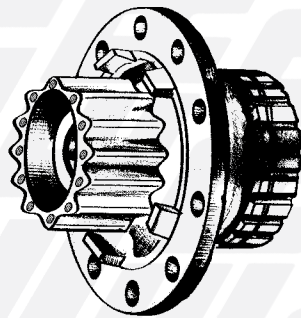

713777

17

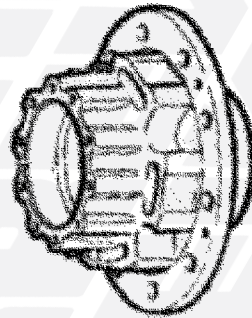

713778

18



728706

19



730760

20

FIG. ITEM	RIF. ERREVI ERREVI REF.	DESCRIZIONE PARTICOLARI DESCRIPTION		TIPO VEHICLE MODEL	RIF. ORIG. ORIG. REF.
1 VOLVO					
1	729393	Colonna fissaggio ruota / <i>Wheel stud</i>	M22x1,5 L=79	FH - FH12 - FH16 - FL6 - FM - FM12	20515514
2	729395	Colonna fissaggio ruota / <i>Wheel stud</i>	M22x1,5 L=105	B7 - B10 - B12 - FH - FM - FH12 FH16 - FM9 - FM12	20515519
3	729387	Colonna fissaggio ruota / <i>Wheel stud</i>	M22x1,5 L=114	FM9 - FM12 - FH12 - FH16	20524942 21147687
4	729624	Dado per colonna / <i>Wheel nut</i>	M22x1.5 H=31 Ch=33	FM9 - FM12 - FH12 - FH16	20551045 21303956 21402076
5	729156	Colonna fissaggio ruota / <i>Wheel stud</i>	7/8"Dx L=102	F7 - F10 - F12 - F16 - N7 - N10 - N12	1573082
6	729198	Colonna fissaggio ruota (con riduttore) / <i>Wheel stud</i>	7/8"Dx L=115	F16	1589009
7	729258	Dado per colonna / <i>Wheel nut</i>	7/8"Dx H=35	F7 - F10 - F12 - F16 N7 - N10 - N12	943491 1083894
8	729804	Dado con guida / <i>Wheel nut</i>	7/8"-14 UNF H tot. 44		-
9	729805	Dado con guida / <i>Wheel nut</i>	7/8"-14 UNF H tot. 50		-
10	729806	Dado con guida / <i>Wheel nut</i>	7/8"-14 UNF H tot. 56		-
11	729807	Dado con guida / <i>Wheel nut</i>	7/8"-14 UNF H tot. 78		-
12	732741	Coperchio per dado colonna / <i>Nut cover</i> Adattabile su tutti i dadi Ch. 32 mm. / <i>Suitable to all 32 mm. key nuts</i>	Ch / Key 32		3943983 1609675
13	729775	Ghiera fissaggio mozzo / <i>Axle nut</i>	M80x2	F10 - F12 - F16 - FL7 - FL10 - FL12 FM7 - FM9 - FM10 - FM12 - FH12 - FH16	1522384
14	729773	Ghiera fissaggio mozzo / <i>Axle locking nut</i>	M86x2	FL6 - FL7 - FL12 - FM7 - FM9 - FM10 FM12 - FH12 - FH16	1076335
15	726374	Rondella di bloccaggio dado assale / <i>Lock washer</i>		FL6-FL7-FL12-FM7-FM9-FM10 FM12-FH12-FH16	8157714
16	713776	Mozzo ruota completo / <i>Wheel hub assembly</i>		FH - FM	85107753
17	713777	Mozzo ruota completo / <i>Wheel hub assembly</i>		FM9 - FM12 - FH12 - FH16	85105696
18	713778	Mozzo ruota completo / <i>Wheel hub assembly</i>		FM9 - FM12 - FH12 - FH16	20517952
19	728706	Kit cuscinetto completo / <i>Bearing assembly</i>	ø 94x148x135	FH - FM - FM9 - FM12 - FH12 - FH16	20967828 1075408 20518661 20792439 20792440 21036050
20	730760	Paraolio mozzo posteriore / <i>Oil seal</i>	ø 168x192,5x32	F7 - F10 - F12 - F16 FL7 - FL10 - FL12 FH12 - FH16	944666 1591903 1610765

1

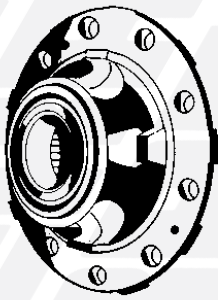

1 - 713901 Nudo / Bare
2 - 713902 Completo / Assembly

NEW

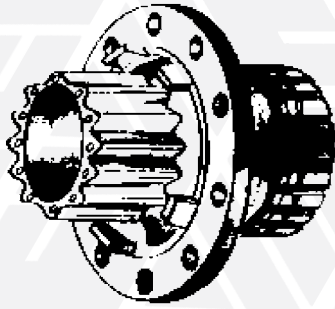

713917
3

NEW

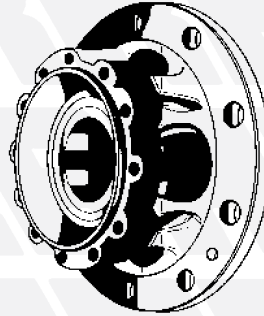

713799
4

NEW

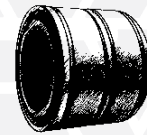

728706
8



730760
15

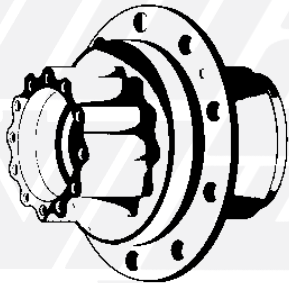

713900
5

NEW



6 - 728718 Int. / Inner
7 - 728719 Est. / Outer

NEW



730760
15



728711
9

NEW



10 - 728733
11 - 728729
12 - 728723
13 - 728722
14 - 728731

NEW

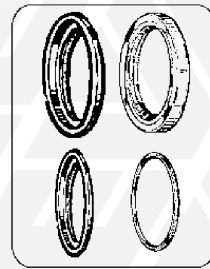

730779
16

NEW



727290
17

NEW

FIG. ITEM	RIF. ERREVI ERREVI REF.	DESCRIZIONE PARTICOLARI DESCRIPTION		TIPO VEHICLE MODEL	RIF. ORIG. ORIG. REF.
<div style="display: flex; align-items: center; justify-content: center;"> <div style="border: 1px solid black; border-radius: 50%; width: 40px; height: 40px; display: flex; align-items: center; justify-content: center; margin-right: 10px;">1</div> <div style="font-size: 24px; font-weight: bold; color: green;">VOLVO</div> </div>					
1	713901	Mozzo ruota nudo / <i>Wheel hub, bare</i>		FH - FM - FH12 - FH16	20819804 20535207 20820402 21328181 21328177
2	713902	Mozzo ruota completo / <i>Wheel hub assembly</i>		FH - FM - FH12 - FH16	20819804S 20535207S 20820402S 21328181S 21328177S
3	713917	Mozzo ruota nudo / <i>Wheel hub, bare</i>		FM - FH	20535263
4	713799	Mozzo ruota completo / <i>Wheel hub assembly</i>		Veicoli 6x4 da cantiere	20820420
5	713900	Mozzo ruota nudo / <i>Wheel hub, bare</i>		F10 - F12 - F16 - FL6 - FL10 - FL7 - FL12 NL10 - NL12 - NH12 - FH12 - FH16	1626992
6	728718	Cuscinetto interno mozzo / <i>Inner bearing</i>	ø 96x160x43	F10 - F12 - F16 - FL6 - FL10 - FL7 - FL12 NL10 - NL12 - NH12 - FH12 - FH16	184795 181278 181279
7	728719	Cuscinetto esterno mozzo / <i>Outer bearing</i>	ø 82,5x145x43	F10 - F12 - F16 - FL6 - FL10 - FL7 - FL12 NL10 - NL12 - NH12 - FH12 - FH16	184794 181280 181281
8	728706	Kit cuscinetto completo / <i>Bearing assembly</i>	ø 94x148x135	FH - FM - FM9 - FM12 - FH12 - FH16	20967828 1075408 20518661 20792439 20792440 21036050
9	728711	Kit cuscinetto completo / <i>Bearing assembly</i>	ø 78x130x90		85103257
10	728733	Cuscinetto interno mozzo / <i>Hub bearing, inner</i>	ø 90x160x42,5		19468 32218A VKHB2030
11	728729	Cuscinetto esterno mozzo / <i>Hub bearing, outer</i>	ø 75x125x37	FL6	184678 33115 VKHB2222
12	728723	Cuscinetto interno mozzo / <i>Hub bearing, inner</i>	ø 95x145x32	FL	20593429 32019XA VKHB2161
13	728722	Cuscinetto esterno mozzo / <i>Hub bearing, outer</i>	ø 90x140x32	FL6	1699173 32018XA VKHB2170
14	728731	Cuscinetto interno mozzo / <i>Hub bearing, inner</i>	ø 100x157x42	F10 - F12 - N10 - N12 - FM7 - FM9 FM10 - FM12 - NL12 - FH12 - FH16 FH - FM	183326 KHM220149,220.110 VKHB2032
15	730760	Paraolio mozzo posteriore / <i>Oil seal</i>	ø 168x192,5x32	F7 - F10 - F12 - F16 FL7 - FL10 - FL12 FH12 - FH16	944666 1591903 1610765
16	730779	Kit paraolio per mozzo / <i>Oil seal kit</i>		FL6 - FL7 - FL10 - FL12 - FM7 FM10 - FM12 - FH12 - FH16	3095043 3095042 8159000
17	727290	Ruota fonica / <i>Impulse wheel</i>	ø 140x164x7 100 denti/teeth	FH12 - FH16 - FL6 - FM10 - FM12 - FM9	20424109

**PONTE POST.
REAR AXLE**

