

AVANTRENO E MOZZI ANTERIORI FRONT AXLE AND WHEELS

RICAMBI PER / SPARE PARTS FOR

ASTRA	pag. 134 - 135
DAF	pag. 134 - 139
FIAT-IVECO	pag. 140 - 141
IVECO	pag. 142 - 163
MAN	pag. 164 - 167
MERCEDES	pag. 168 - 173
NISSAN	pag. 174 - 175
RENAULT	pag. 176 - 179
SCANIA	pag. 180 - 183
VOLVO	pag. 184 - 189

1

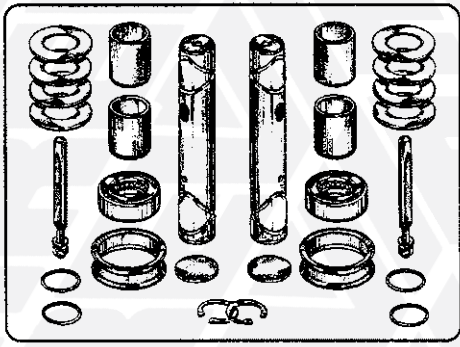

711708
1



729335
5

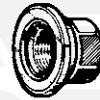

729657
8



729337
6



729657
8



729173
7

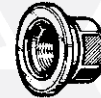

729657
8

2

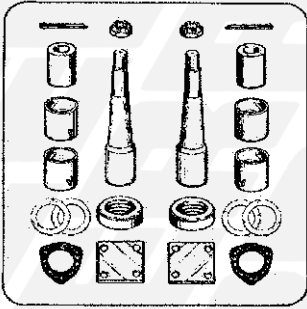

9 - 711375

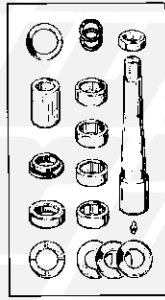

10 - S11384
NEW

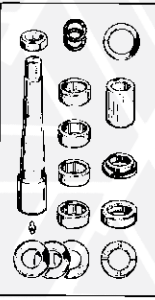

10 - S11384
NEW

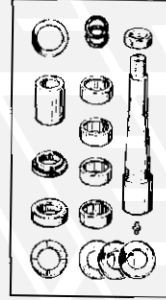

12 - S11739
NEW

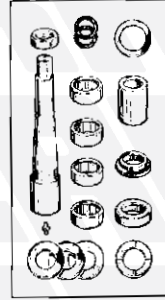

12 - S11739
NEW

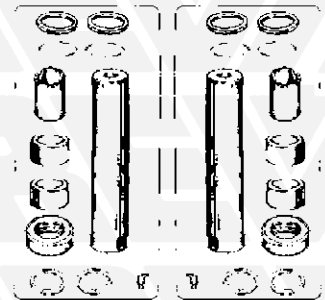

14 - S11823
NEW

14 - S11823
NEW

11 - 711384

13 - 711739

15 - 711823

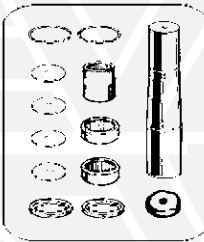

16 - S11891
NEW

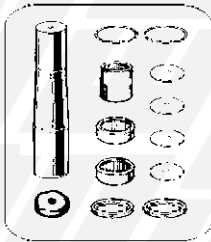

16 - S11891
NEW

17 - 711891

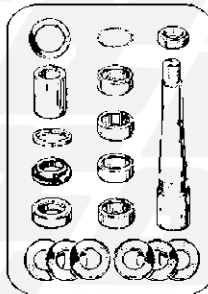

18 - S11892
NEW

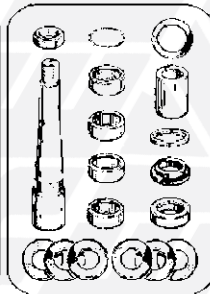

18 - S11892
NEW

19 - 711892

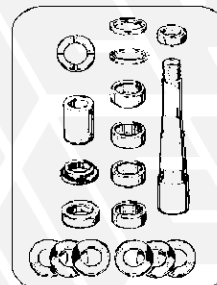

20 - S11893
NEW

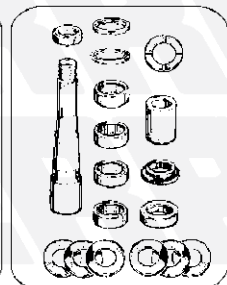

20 - S11893
NEW

21 - 711893

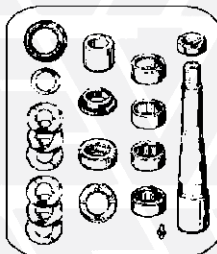

22 - S11771
NEW

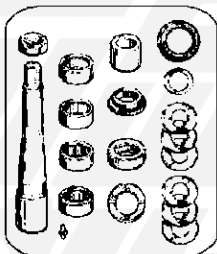

22 - S11771
NEW

23 - 711771

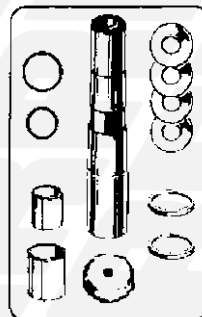

24 - S11787
NEW

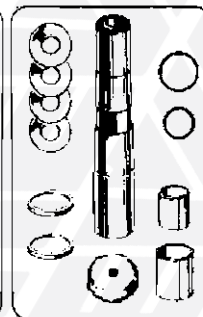

24 - S11787
NEW

25 - 711787

FIG. ITEM	RIF. ERREVI ERREVI REF.	DESCRIZIONE PARTICOLARI DESCRIPTION	TIPO VEHICLE MODEL	RIF. ORIG. ORIG. REF.
<div style="display: flex; align-items: center;"> <div style="font-size: 2em; margin-right: 10px;">1</div> <div> <h2 style="margin: 0;">ASTRA</h2> <p style="margin: 0;">BM304F - BM305F - BM64.26 - BM64.30 - BM64.36 HD7 (64.34-64.38-64.42-64.45-64.52) - HD8 (4x2 - 4x4 - 6x4 - 6x6 - 8x4)</p> </div> </div>				
1	711708	Compressivo revisione perni fusi (2 RUOTE) con cuscinetti <i>King pin repair kit (Services 2 WHEELS) c/w bearings</i>		1009095
2	725778	Boccola sup. e inf. perno fuso / <i>King pin bush</i>	ø 46,3x52,7x55	179957 30209
3	719854	Perno fuso / <i>King pin</i>	ø 46x245	100909
4	728595	Reggispinta perno fuso / <i>King pin thrust bearing</i>		30198
MOZZI E RUOTE / HUBS AND WHEELS				
5	729335	Colonna fissaggio mozzi / <i>Wheel stud</i>	M22x1,5 L=72	BM304F - BM305F 40045
6	729337	Colonna fissaggio mozzi / <i>Wheel stud</i>	M22x1,5 L=90	BM64.26 - BM64.30 - BM64.36 HD7 (64.34-64.38-64.42-64.45-64.52) 151545
7	729173	Colonna fissaggio mozzi U.T. / <i>Wheel stud</i>	M22x1,5 L=92	HD7 (64.34-64.38-64.42-64.45-64.52) HD8 (4x2 - 4x4 - 6x4 - 6x6 - 8x4) 125100 119026
8	729657	Dado per colonna / <i>Wheel nut</i>	M22x1,5	HD8 (4x2 - 4x4 - 6x4 - 6x6 - 8x4) 40051
<div style="display: flex; align-items: center;"> <div style="font-size: 2em; margin-right: 10px;">2</div> <div> <h2 style="margin: 0;">DAF</h2> </div> </div>				
9	711375	Compressivo revisione perni fusi (2 RUOTE) <i>King pin repair kit (Services 2 WHEELS)</i>	Perno / Pin ø 31,5/50 L=275	2100 - 2300 - 2500 - 2800 - 3600 0118086
10	S11384	Compressivo revisione perni fusi (1 RUOTA) <i>King pin repair kit (Services 1 WHEEL)</i>	Perno / Pin ø 31,5/50 L=270	2100 - 2300 - 2500 - 2800 - 3600 0680374 0681621
11	711384	Compressivo revisione perni fusi (2 RUOTE) <i>King pin repair kit (Services 2 WHEELS)</i>		
12	S11739	Compressivo revisione perni fusi (1 RUOTA) <i>King pin repair kit (Services 1 WHEEL)</i>	Perno / Pin ø 31,5/50 L=272	F1700 - F2100 - F65 - F75 - F85 F95 - 65CF - 75CF - 85CF - 95XF 0681706
13	711739	Compressivo revisione perni fusi (2 RUOTE) <i>King pin repair kit (Services 2 WHEELS)</i>		
14	S11823	Compressivo revisione perni fusi (1 RUOTA) <i>King pin repair kit (Services 1 WHEEL)</i>	Perno / Pin ø 45 L=215	LF55 0683485 1895527
15	711823	Compressivo revisione perni fusi (2 RUOTE) <i>King pin repair kit (Services 2 WHEELS)</i>		
16	S11891	Compressivo revisione perni fusi (1 RUOTA) <i>King pin repair kit (Services 1 WHEEL)</i>	Perno / Pin ø 32/40 L=171,5	LF45 0683466 0683590 1895528
17	711891	Compressivo revisione perni fusi (2 RUOTE) <i>King pin repair kit (Services 2 WHEELS)</i>		
18	S11892	Compressivo revisione perni fusi (1 RUOTA) <i>King pin repair kit (Services 1 WHEEL)</i>	Perno / Pin ø 40,5/55 L=292	F75 - F85 - F95 75CF - 85CF - 95XF 0681702 0683392
19	711892	Compressivo revisione perni fusi (2 RUOTE) <i>King pin repair kit (Services 2 WHEELS)</i>		
20	S11893	Compressivo revisione perni fusi (1 RUOTA) <i>King pin repair kit (Services 1 WHEEL)</i>	Perno / Pin ø 40,5/55 L=266	75CF - 85CF CF75 - CF85 - XF95 - XF105 0683470 1895526
21	711893	Compressivo revisione perni fusi (2 RUOTE) <i>King pin repair kit (Services 2 WHEELS)</i>		
22	S11771	Compressivo revisione perni fusi (1 RUOTA) <i>King pin repair kit (Services 1 WHEEL)</i>	Perno / Pin ø 50 L=253	65CF - 75CF - 85CF - 95XF CF65 - CF75 - CF95 - XF105 0683499 1895529
23	711771	Compressivo revisione perni fusi (2 RUOTE) <i>King pin repair kit (Services 2 WHEELS)</i>		
24	S11787	Compressivo revisione perni fusi (1 RUOTA) <i>King pin repair kit (Services 1 WHEEL)</i>	Perno / Pin ø 32/40 L=171	LF45 0683469 1895530
25	711787	Compressivo revisione perni fusi (2 RUOTE) <i>King pin repair kit (Services 2 WHEELS)</i>		



1 - 728726
 2 - 728730
 3 - 728715



729783
 4

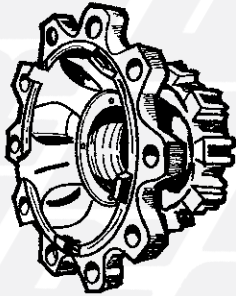

5 - 713911 Nudo / Bare
 6 - 713759 Compl. / Assembly
 7 - 713910 Compl. FAG / FAG Assembly



728700
 8

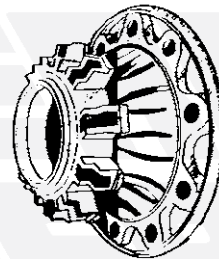

13 - 713915 Nudo / Bare
 14 - 713797 Compl. / Assembly
 15 - 713914 Compl. FAG / FAG Assembly



728717
 16

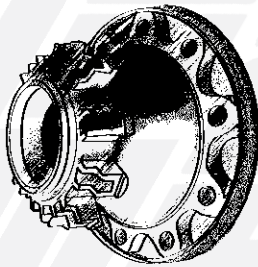

9 - 713913 Nudo / Bare
 10 - 713772 Compl. / Assembly
 11 - 713912 Compl. FAG / FAG Assembly



728702
 12

FIG. ITEM	RIF. ERREVI ERREVI REF.	DESCRIZIONE PARTICOLARI DESCRIPTION		TIPO VEHICLE MODEL	RIF. ORIG. ORIG. REF.
MOZZI E RUOTE / HUBS AND WHEELS					
1	728726	Cuscinetto interno ed esterno mozzo / <i>Hub bearing</i>	ø45x100x38,25	95 FA - 95 FT	283684 283686 140896 32309A VKHB2004
2	728730	Cuscinetto mozzo / <i>Hub bearing</i>	ø 50x90x32	F2000 - F2100 - F2300 - F2800	614943 33210 VKHB2068
3	728715	Cuscinetto ruota / <i>Wheel bearing</i>	ø55x95x30	LF45	1400081
4	729783	Dado fissaggio mozzo / <i>Wheel nut</i>	M58x1,5		1396606
5	713911	Mozzo ruota nudo / <i>Wheel hub, bare</i>		XF95 - 95XF	1391615S 1697346S 1388905S
6	713759	Mozzo ruota completo / <i>Wheel hub assembly</i>		XF95 - 95XF	1391615 1697346 1388905
7	713910	Mozzo ruota completo di cuscinetto FAG <i>Wheel hub assembly (complete with FAG bearing)</i>		XF95 - 95XF	1391615 1697346 1388905
8	728700	Kit cuscinetto completo / <i>Bearing assembly</i>	ø 70x120x110	XF95 - 95XF	1801595
9	713913	Mozzo ruota nudo / <i>Wheel hub, bare</i>		XF95 - 95XF	1691621S 1699327S 1818004S
10	713772	Mozzo ruota completo / <i>Wheel hub assembly</i>		XF95 - 95XF	1818004 1691621 1699327
11	713912	Mozzo ruota completo di cuscinetto FAG <i>Wheel hub assembly (complete with FAG bearing)</i>		XF95 - 95XF	1691621 1699327 1818004
12	728702	Kit cuscinetto completo / <i>Bearing assembly</i>	ø 70x125x114	XF95 - 95XF	1801592
13	713915	Mozzo ruota nudo / <i>Wheel hub, bare</i>		CF75 - CF85 - XF105	1812160S 1428396S 1613331S
14	713797	Mozzo ruota completo / <i>Wheel hub assembly</i>		CF75 - CF85 - XF105	1812160 1428396 1613331
15	713914	Mozzo ruota completo di cuscinetto FAG <i>Wheel hub assembly (complete with FAG bearing)</i>		CF75 - CF85 - XF105	1812160 1428396 1613331
16	728717	Kit cuscinetto completo / <i>Bearing assembly</i>	ø 82x138x130	CF75-CF85 - XF95-XF105	1801593



730857
1



719114
2



719108
3



719109
4



729627
7



729388
6



729398
8



719116
5

NEW



729783
13



729629
12



9 - 729379 L = 72
10 - 729340 L = 85
11 - 729342 L = 94



730788
14

NEW



730780
15



730783
16



730784
17



730782
18



730781
19



726375
20



726376
21



727257
22



727259
23



727287
24

FIG. ITEM	RIF. ERREVI ERREVI REF.	DESCRIZIONE PARTICOLARI DESCRIPTION		TIPO VEHICLE MODEL	RIF. ORIG. ORIG. REF.
MOZZI E RUOTE / HUBS AND WHEELS					
1	730857	Anello di tenuta / <i>O.Ring</i>		XF95 - 95XF	1692506
2	719114	Calotta coprimozzo / <i>Hub cap</i>		LF45	1406287
3	719108	Calotta coprimozzo / <i>Hub cap</i>		XF95 - 95XF	1691965
4	719109	Calotta coprimozzo / <i>Hub cap</i>		XF95 - 95XF	1339107
5	719116	Calotta coprimozzo completa di o.ring / <i>Hub cap assembly</i>	ø 116	LF55	1405816 1400063
6	729388	Colonna fissaggio ruota / <i>Wheel stud</i>	M18x1,5 L=57	LF45	1400082 1703948
7	729627	Dado per colonna / <i>Wheel nut</i>	M18x1,5 H=23 Ch/Key 27	LF45	1402420 0620650
8	729398	Colonna fissaggio ruota / <i>Wheel stud</i>	M20x1,5 L=85	LF45 - LF55	1400065 PAK4938
9	729379	Colonna fissaggio ruota / <i>Wheel stud</i>	M22x1,5 L=72		1337020 0099720 0099721
10	729340	Colonna fissaggio ruota / <i>Wheel stud</i>	M22x1,5 L=85	2100 - 2300 - 2500 - 2800 - 3600	620646 99730 1309191
11	729342	Colonna fissaggio ruota / <i>Wheel stud</i>	M22x1,5 L=94	85CF - 85FA - 95FA - 95XF	1309190 1356736 890763
12	729629	Dado per colonna / <i>Wheel nut</i>	M22x1,5	2100 - 2300 - 2500 - 2800 - 3600	652575
13	729783	Dado fissaggio mozzo / <i>Wheel nut</i>	M58x1,5		1396606
14	730788	Paraolio interno mozzo / <i>Oil seal, inner</i>	ø 98x166x22	65CF - 75CF - 85CF - 95XF CF65 - XF95 - XF105 LF45	1334961
15	730780	Paraolio mozzo / <i>Oil seal</i>	ø 82x105x10	LF45	1400080
16	730783	Paraolio interno mozzo / <i>Oil seal, inner</i>	ø 100x135x13	65CF - 75CF - 85CF - 95XF	0647330
17	730784	Paraolio interno mozzo / <i>Oil seal, inner</i>	ø 100x140x20	65CF - 75CF - 85CF - 95XF	1238034
18	730782	Paraolio interno mozzo / <i>Oil seal, inner</i>	ø 120x164,5x19,5	65CF - 75CF	0678157
19	730781	Paraolio interno mozzo / <i>Oil seal, inner</i>	ø 124,5x164,5x17,5	75CF - 85CF - 95XF - CF65 - CF75 - CF85	0292766
20	726375	Rondella fissaggio mozzo / <i>Retaining washer</i>	ø 69,5x119x9	LF55 - CF65 - CF75 - CF85 - XF95 - XF105	1692215
21	726376	Rondella fissaggio mozzo / <i>Retaining washer</i>	ø 69,5x119x9	XF95 - XF105	1692209 1385327
22	727257	Ruota fonica / <i>Impulse wheel</i>	ø 118x148x13 100 denti / <i>teeth</i>	XF95 - 95XF	1805821 1391515
23	727259	Ruota fonica / <i>Impulse wheel</i>	ø 168x212x18 100 denti / <i>teeth</i>	CF65 - CF75 - CF85	1805824 1657638
24	727287	Ruota fonica / <i>Impulse wheel</i>	ø 138x170x13	CF75 - CF85 85CF	1391516 1805822

1

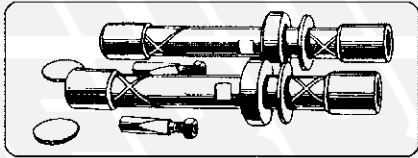

711095
1

2

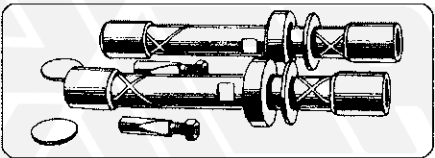

711097
2

3

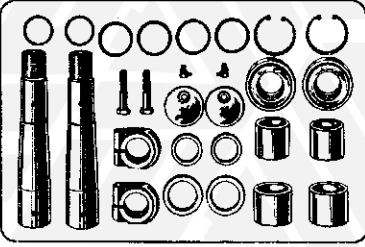

711164
3

4



4 - 729144
5 - 729353
729626
6



8 - 729617 D./RH
9 - 729618 S./LH



14 - 728652 Int. / Inner
15 - 728653 Est. / Outer

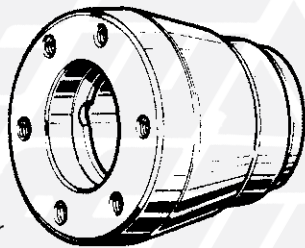

713551
13



730732
17

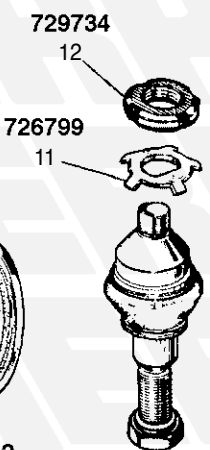

713099
19

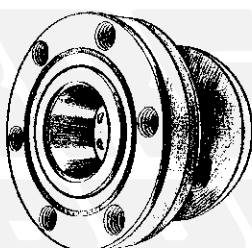

713783
16



729698
10



726640
18

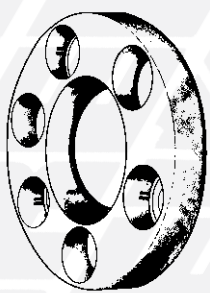

733401
7

FIG. ITEM	RIF. ERREVI ERREVI REF.	DESCRIZIONE PARTICOLARI DESCRIPTION	TIPO VEHICLE MODEL	RIF. ORIG. ORIG. REF.
FIAT-IVECO				
1 LUPETTO 2ª Serie - LEONCINO 3ª Serie				
1	711095	Complessivo revisione perni fusi (2 RUOTE) con cuscinetti King pin repair kit (Services 2 WHEELS) c/w bearings	Perno / Pin ø 26 L=178	-
2 LUPETTO 3M - LEONCINO 3M - CERBIATTO - DAINO - TIGROTTO				
2	711097	Complessivo revisione perni fusi (2 RUOTE) con cuscinetti King pin repair kit (Services 2 WHEELS) c/w bearings	Perno / Pin ø 28,8 L=178	-
3 TIGROTTO 65 q.li / 6.5 tons				
3	711164	Complessivo revisione perni fusi (2 RUOTE) con cuscinetti King pin repair kit (Services 2 WHEELS) c/w bearings	Perno / Pin ø 27/34 L=213	-
4 DAILY - NEW DAILY (30.8 - 30.9 - 32.8 - 35.8 - 35.9 - 40.8) TURBO DAILY (30.10 - 35.10 - 35.12 - 45.10 - 49.10 - 49.12) MOZZI E RUOTE / HUBS AND WHEELS				
4	729144	Colonna fissaggio ruota / Wheel stud	M18x1,5 L=57	93800663
5	729353	Colonna fissaggio ruota / Wheel stud	M18x1,5 L=72	59.12 TURBO DAILY 93816209
6	729626	Dado per colonna / Wheel nut	M18x1,5	93805743 99474404 4459602
7	733401	Copertura protezione ruote / Wheel cover		59.11 DAILY CNG 59.12 TURBO DAILY (96) DAILY 2006 - 2009 - 2012 65-70 C14/C15/C17/C18/C21 EUROCARGO 60-65E10/E12/E14 - 75E12/E14/E15 E.CARGO "Tector" 75E13/E15/E17 99477376
8	729617	Dado D. per fuso S. / Left hand knuckle nut RH	M24x1,5	14044471
9	729618	Dado S. per fuso D. / Right hand knuckle nut LH	M24x1,5	14045171
10	729698	Dado per fuso / Knuckle nut	M27x1,5	35.8 NEW DAILY 96 35.10/ .12 - 49.10/ .12 TURBO DAILY 96 7173068
11	726799	Fermo per ghiera / Lockring		93807321
12	729734	Ghiera bloccaggio snodo articolazione fuso / Locknut	M20x1,5	93802356
13	713551	Mozzo ruota nudo / Front hub bare		30.8 - 30.9 - 30.10 - 35.8 35.9 - 35.10 - 40.8 93804574
14	728652	Cuscinetto interno mozzo / Hub bearing, inner	ø 40x80x25	
15	728653	Cuscinetto esterno mozzo / Hub bearing, outer	ø 25x62x18,25	DAILY 30.8/.9/.10 - 35.8/.9/.10 - 40.8 NEW DAILY 30.8/.9/.10-35.8/.9/.10-40.8 TURBO DAILY 30.8/.9/.10 - 35.8/.9/.10 26800330 93803935 VKHB2262
16	713783	Mozzo ruota completo / Wheel hub assembly		DAILY CNG 59.11 TURBODAILY 59.12 93810034
17	730732	Paraolio mozzi / Oil seal	ø 55x80x10	93804576 40003260
18	726640	Rondella per dado fuso / Flat washer	ø 35x60x6	35.8 NEW DAILY 96 35.10/ .12 - 49.10/ .12 TURBO DAILY 96 7173075
19	713099	Snodo articolazione fuso / Ball joint		93807545 93802242

1

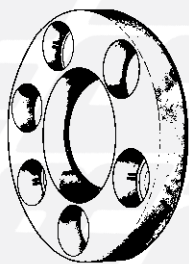

733401
1



729698
2



726640
6



729734
4



726799
3

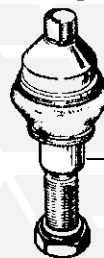

713099
7



729740
5



713109
8



9 - 729144
10 - 729353



729626
11

2

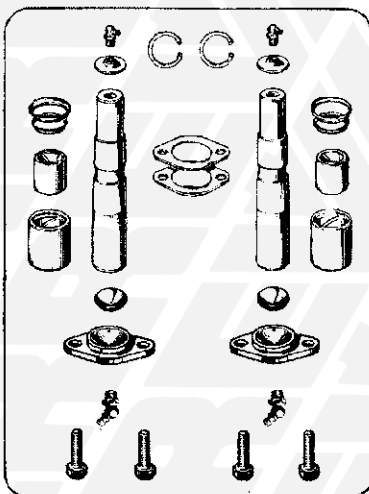

711702
12

3

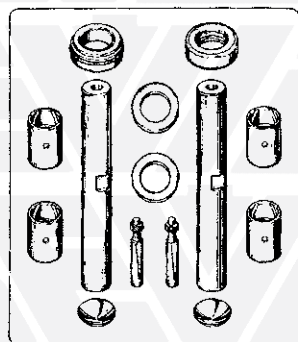

13 - 711255
14 - 711345
15 - 711346
16 - 711254
17 - 711141



726915
22

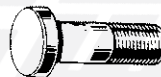

729033
19



729043
21



729026
20



729025
23



719015
18

FIG. ITEM	RIF. ERREVI ERREVI REF.	DESCRIZIONE PARTICOLARI DESCRIPTION	TIPO VEHICLE MODEL	RIF. ORIG. ORIG. REF.
IVECO				
1 DAILY U.TIPO 35C9/C10/C11/C12/C13/C15 - 50C11/C13/C15 - 65C11/C13/C15 MOZZI E RUOTE / HUBS AND WHEELS				
1	733401	Copertura protezione ruote / <i>Wheel cover</i>	59.11 DAILY CNG 59.12 TURBO DAILY (96) DAILY 2006 - 2009 - 2012 65-70 C14/C15/C17/C18/C21 EUROCARGO 60-65E10/E12/E14 - 75E12/E14/E15 E.CARGO "Tector" 75E13/E15/E17	99477376
2	729698	Dado per fuso / <i>Knuckle nut</i>	M27x1,5	7173068
3	726799	Fermo per ghiera / <i>Lockring</i>		93807321
4	729734	Ghiera bloccaggio snodo articolazione fuso / <i>Locknut</i>	M20x1,5	93802356
5	729740	Ghiera bloccaggio snodo articolazione / <i>Locknut</i>	M20x1	DAILY 2006 - 35C12 504212925
6	726640	Rondella per dado fuso / <i>Flat washer</i>	ø 35x60x6	7173075
7	713099	Snodo articolazione fuso / <i>Ball joint</i>		93807545 93802242
8	713109	Snodo articolazione fuso / <i>Ball joint</i>		DAILY 2006 - 35C12 504212586 504212584
9	729144	Colonna fissaggio ruota / <i>Wheel stud</i>	M18x1,5 L=57	35C9/C10/C11/C12/C13/C15 93800663
10	729353	Colonna fissaggio ruota / <i>Wheel stud</i>	M18x1,5 L=72	65C11/C13/C15 93816209
11	729626	Dado per colonna / <i>Wheel nut</i>	M18x1,5	93805743 99474404
2 DAILY DUTY (30.8H - 35.8H - 40.8H) FUSI A SNODO / STEERING KNUCKLES				
12	711702	Completivo revisione perni fusi (2 RUOTE) <i>King pin repair kit (Services 2 WHEELS)</i>	Perno / <i>Pin</i> ø 21/27 L=136	1905817
3 35NC - 40NC - 40/35NC - 50NC - 55NC - 60/65NC - 70NC - 75NC FUSI A SNODO / STEERING KNUCKLES				
13	711255	Completivo revisione perni fusi (2 RUOTE) <i>King pin repair kit (Services 2 WHEELS)</i>	Perno / <i>Pin</i> ø 26 L=154	35NC - 40NC - 40/35NC -
14	711345	Completivo perni fusi c/perni magg. 2/10 <i>King pin set O/S 2/10</i>	Perno / <i>Pin</i> ø 26,2 L=154	35NC - 40NC - 40/35NC -
15	711346	Completivo perni fusi c/perni magg. 4/10 <i>King pin set O/S 4/10</i>	Perno / <i>Pin</i> ø 26,4 L=154	35NC - 40NC - 40/35NC -
16	711254	Completivo revisione perni fusi (2 RUOTE) <i>King pin repair kit (Services 2 WHEELS)</i>	Perno / <i>Pin</i> ø 28,75 L=187	50NC - 55NC -
17	711141	Completivo revisione perni fusi (2 RUOTE) <i>King pin repair kit (Services 2 WHEELS)</i>	Perno / <i>Pin</i> ø 28,75 L=187	60/65NC - 70NC - 75NC -
MOZZI E RUOTE / HUBS AND WHEELS				
18	719015	Calotta coprimozzo / <i>Hub cap</i>	M75x1,5	8543870
19	729033	Colonna ruota / <i>Wheel stud</i>	M18x1,5 L=49	8541412
20	729026	Dado per colonna / <i>Wheel nut</i>	M18x1,5	15501521 17039221 12164221 12164211
21	729043	Rondella spaccata per dado colonna / <i>Lockwasher</i>		1121808 8527733
22	726915	Rondella di sicurezza per dado mozzo / <i>Lockwasher</i>		8558082
23	729025	Dado per colonna / <i>Wheel nut</i>	M18x1,5	8527734

1

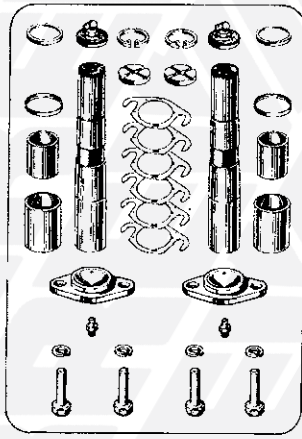

711178
1



729183 2 729043 8 729026 6



729184 4 729043 8 729026 6



729037
3



729185 5 729028 7

2

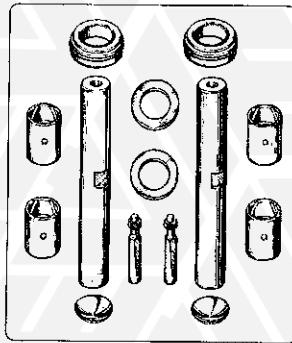

711253
9

3

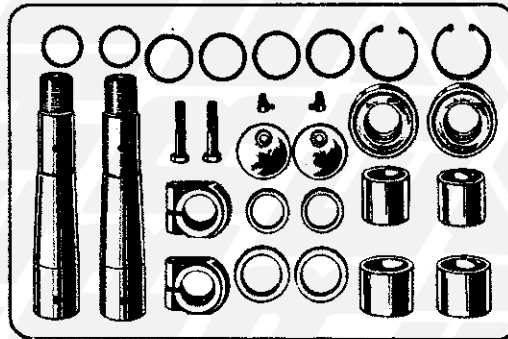

711164
10

4

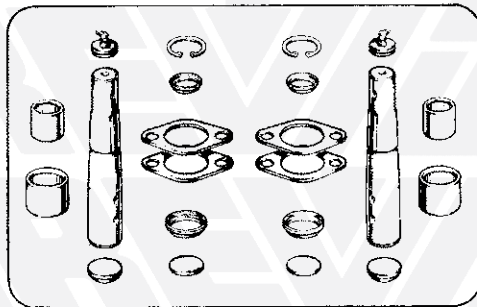

711304
11

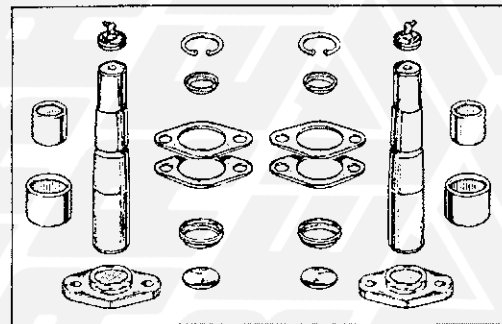

711349 (U.T.)
12



729185 13 729028 15



729177 14

729629 CH 32 - H 31
16

729657 CH 32 - H 27
17

FIG. ITEM	RIF. ERREVI ERREVI REF.	DESCRIZIONE PARTICOLARI DESCRIPTION	TIPO VEHICLE MODEL	RIF. ORIG. ORIG. REF.
1 50.8/F8 - 50.9/F9 - 50.10/F10 - 55.8/F8 - 55.9/F9 55.10/F10 - 60.8/F8 - 60.10/F10 - 65.10/F10 70.10/F10 - 75.10/F10 - 79.10/F10 - 79.13/F13 80.13/F13 - 90.13/F13 - 50.9Z - 60.11 TURBO Z 65.9Z - 65.12 TURBO Z 79.14/ .14Z - 95.14/ .14Z - 109.14/ .14Z FUSI A SNODO / STEERING KNUCKLES				
1	711178	Complessivo revisione perni fusi (2 RUOTE) King pin repair kit (Services 2 WHEELS)	Perno / Pin ø 27/34 L=174	1904814
MOZZI E RUOTE / HUBS AND WHEELS				
2	729183	Colonna fissaggio ruota 1ª Serie / Wheel stud	M18x1,5 L=58	7163380
3	729037	Colonna fissaggio ruota / Wheel stud	M18x1,5 L=45	7161200 7168347
4	729184	Colonna fissaggio ruota - U. TIPO / Wheel stud	M18x1,5 L=58	7168330
5	729185	Colonna fissaggio ruota / Wheel stud	M20x1,5 L=76	7171530 7168849 7160357 42014521
6	729026	Dado per colonna ruota / Wheel nut	M18x1,5	15501521 15501524
7	729028	Dado per colonna ruota / Wheel nut	M20x1,5	2476979
8	729043	Rondella spaccata per dado colonna / Lockwasher		1121808 8527733
2 80NC - 90NC FUSI A SNODO / STEERING KNUCKLES				
9	711253	Complessivo revisione perni fusi (2 RUOTE) King pin repair kit (Services 2 WHEELS)	Perno / Pin ø 30,6 L=187	-
3 645N1/ N2/ N3 - 650N1/ N2/ N3 - 655 100NC - 110NC - 100F13 - 110.14 FUSI A SNODO / STEERING KNUCKLES				
10	711164	Complessivo revisione perni fusi (2 RUOTE) King pin repair kit (Services 2 WHEELS)	Perno / Pin ø 27/34 L=213	-
4 115.14/ .17 - 135.14/ .17 - 145.17 FUSI A SNODO / STEERING KNUCKLES				
11	711304	Complessivo revisione perni fusi (2 RUOTE) King pin repair kit (Services 2 WHEELS)	Perno / Pin ø 34/42 L=202	-
12	711349	Complessivo revisione perni fusi (2 RUOTE) King pin repair kit (Services 2 WHEELS)	Perno / Pin ø 34/42 L=202	-
MOZZI E RUOTE / HUBS AND WHEELS				
13	729185	Colonna fissaggio ruota - U.T. / Wheel stud	M20x1,5 L=76	7168849 7160357 7171530 42014521
14	729177	Colonna fissaggio ruota / Wheel stud	M22x1,5 L=77	145.17 7168925
15	729028	Dado per colonna / Wheel nut	M20x1,5	2476979
16	729629	Dado per colonna 1ª Serie / Wheel nut	M22x1,5 H=31	145.17 4459603
17	729657	Dado per colonna U.T. / Wheel nut	M22x1,5 H=27	145.17 41031725

1

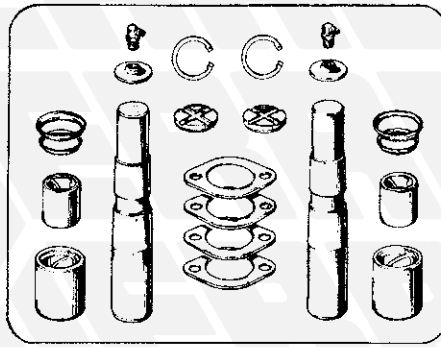

711330
1

2

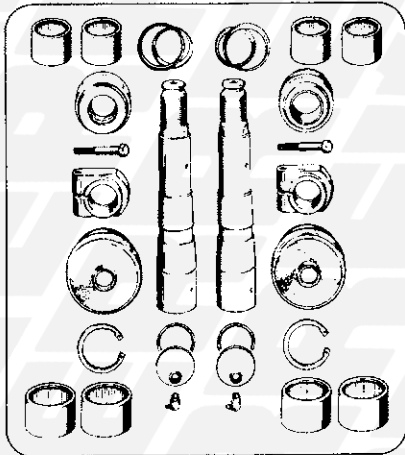

711144
2



729054
3



729046
7



729029 CH 30 - H 22
4

729629 CH 32 - H 31
5

729657 CH 32 - H 27
6

3

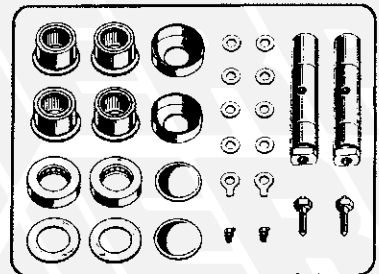

8 - 711099

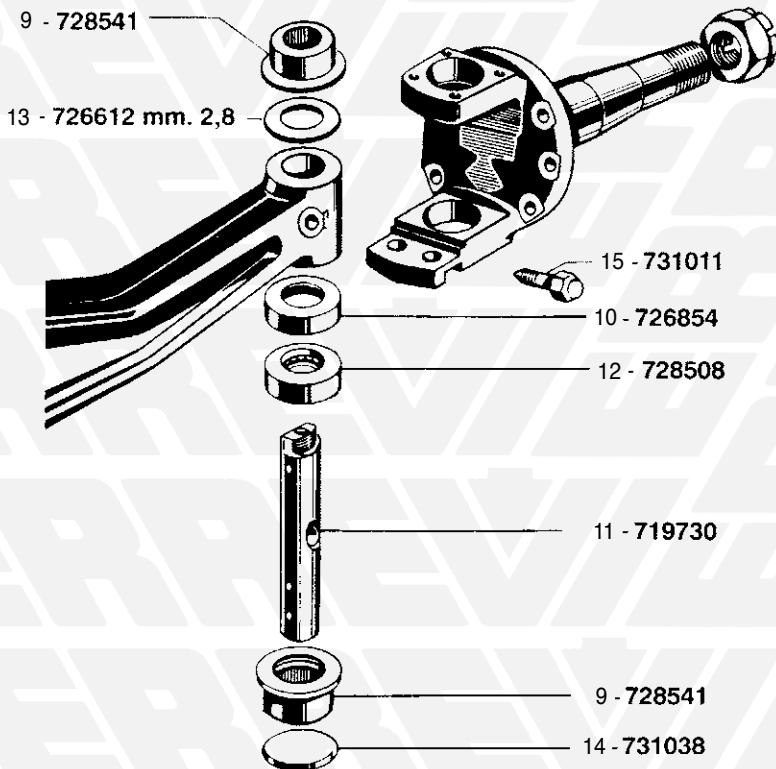

728820
16



728903
18

FIG. ITEM	RIF. ERREVI ERREVI REF.	DESCRIZIONE PARTICOLARI DESCRIPTION	TIPO VEHICLE MODEL	RIF. ORIG. ORIG. REF.
1 100.13 120.13/ .14/ 150.14/ .17/ NC17/ NC20/ FUSI A SNODO / STEERING KNUCKLES				
1	711330	Completivo revisione perni fusi (2 RUOTE) <i>King pin repair kit (Services 2 WHEELS)</i>	Perno / Pin ø 34/42 L=202	1907613 1904808
2 159.17 - 165.24R/ 175.17 - 175.24R/ FUSI A SNODO / STEERING KNUCKLES				
2	711144	Completivo revisione perni fusi (2 RUOTE) con cuscinetti <i>King pin repair kit (Services 2 WHEELS) c/w bearings</i>	Perno / Pin ø 41,3/50,8 L=277	1904805
MOZZI E RUOTE / HUBS AND WHEELS				
3	729054	Colonna fissaggio ruota / <i>Wheel stud</i>	M22x1,5 L=86	7168580 2476077
4	729029	Dado per colonna 1ª Serie / <i>Wheel nut</i>	M22x1,5 H=22	41800483
5	729629	Dado per colonna 2ª Serie / <i>Wheel nut</i>	M22x1,5 H=31	4459603
6	729657	Dado per colonna U.T. / <i>Wheel nut</i>	M22x1,5 H=27	41031725
7	729046	Rondella per dado colonna / <i>Lockwasher</i>		504023611 1121811
3 682 - 691 - 180 E DERIVATI FUSI A SNODO / STEERING KNUCKLES				
8	711099	Completivo revisione perni fusi (2 RUOTE) con cuscinetti <i>King pin repair kit (Services 2 WHEELS) c/w bearings</i>		-
9	728541	Cuscinetto ad aghi per fuso / <i>King pin needle bearing</i>		608911
10	726854	Custodia per reggispinga perno fuso / <i>Thrust bearing casing</i>		608917
11	719730	Perno per fuso snodo / <i>King pin</i>	ø 40 L=220	4722939 4507464
12	728508	Reggispinga per fuso / <i>King pin thrust bearing</i>	ø 40,2/41,3x72,5x21	608916 617710
13	726612	Rondella rasamento assale / <i>Thrust washer</i>	ø 40x69x2,8	608901
14	731038	Tappo in lamiera inf. per fuso / <i>King pin plug</i>		10160801
15	731011	Vite fissaggio perno fuso / <i>Screw</i>		4520406 713195
MOZZI E RUOTE / HUBS AND WHEELS				
16	728820	Bullone per raggiera con dado / <i>Wheel stud</i>	M18x2,5 L=55	865557 4564398
17	728751	Dado per bullone raggiera / <i>Wheel nut</i>	M18x2,5	865559
18	728903	Tassello fissaggio ruota / <i>Wheel pad</i>		392069

1

711147
1

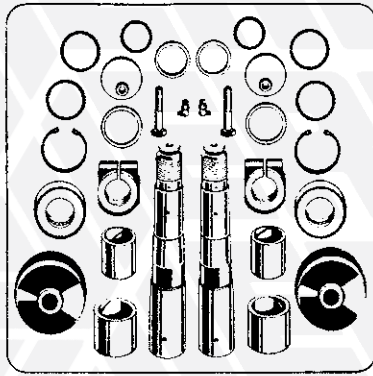

728903
4



728820
2

2

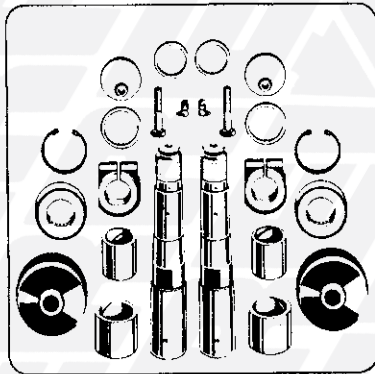

711256
5



729054
6



729046
8



729029
7

3

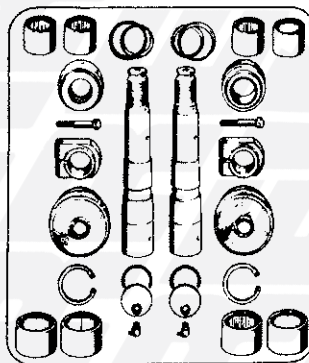

711144
9



729054
10



729046
17



729029
11



728661 Est. / Outer
14

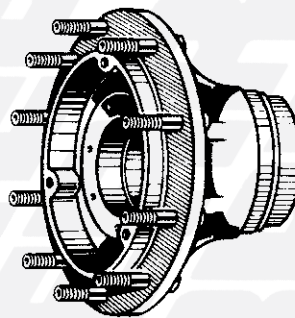

713537
12



728660 Int. / Inner
13



730767
15



730777
16

FIG. ITEM	RIF. ERREVI ERREVI REF.	DESCRIZIONE PARTICOLARI DESCRIPTION	TIPO VEHICLE MODEL	RIF. ORIG. ORIG. REF.
1 619N1/ N1P - 300PC/ PT - 159NC17/ NC20/ NR20/ NT20 - 160.26 170/190NC26/ NT26/ NC33/ NT33 - 170NC35/ NT35 - 170/190F26/ F35 170/190F35 HIDRO/ F35T/ F35T HIDRO FUSI A SNODO / STEERING KNUCKLES				
1	711147	Compressivo revisione perni fusi (2 RUOTE) King pin repair kit (Services 2 WHEELS)	Perno / Pin ø 41,3/50,8 L=277	-
MOZZI E RUOTE / HUBS AND WHEELS				
2	728820	Bullone per raggiera con dado / Wheel stud	M18x2,5 L=55	4564398
3	728751	Dado per bullone raggiera / Wheel nut	M18x2,5	865559
5	728903	Tassello fissaggio ruota / Wheel pad		392069
2 159.17 - 159.20/ - 159F17/ F20/ - 170/190.26/ .35/ 330F26/ F26 HIDRO - 330F35/ F35 HIDRO/ F35T HIDRO FUSI A SNODO / STEERING KNUCKLES				
5	711256	Compressivo revisione perni fusi (2 RUOTE) King pin repair kit (Services 2 WHEELS)	Perno / Pin ø 41,3/50,8 L=277	-
MOZZI E RUOTE (VEICOLI CON MOZZI) / HUBS AND WHEELS (VEHICLES WITH HUBS)				
6	729054	Colonna fissaggio ruota / Wheel stud	M22x1,5 L=86	7168580 2476077
7	729029	Dado per colonna / Wheel nut	M22x1,5	41800483 41800304
8	729046	Rondella spaccata per colonna / Lockwasher		504023611 1121811
3 180.24/ .24T - 180.26 - 190i26/ i26T/ i35/ I35t - 190.30/ .30P/ .30T/ .30PT 190.38/ .38P/ .38T/ .38PT - 190.33/ .36/ .42/ .48 e deriv. TURBOSTAR 220.38T/ .38PT - 220F35T - 220.36PT - 240.30/ .30P - 240.38/ .38P - 240.36P FUSI A SNODO / STEERING KNUCKLES				
9	711144	Compressivo revisione perni fusi (2 RUOTE) con cuscinetti King pin repair kit (Services 2 WHEELS) c/w bearings	Perno / Pin ø 41,3/50,8 L=277	2ª Serie con MOZZI 2 nd Series with HUBS 1904805
MOZZI E RUOTE (VEICOLI CON MOZZI) / HUBS AND WHEELS (VEHICLES WITH HUBS)				
10	729054	Colonna fissaggio ruota / Wheel stud	M22x1,5 L=86	7168580 2476077
11	729029	Dado per colonna / Wheel nut	M22x1,5	41800483
12	713537	Mozzo ruota compl. di colonnette / Front hub assy		7168588 7168586 7162810 7162807
13	728660	Cuscinetto interno mozzo / Hub bearing, inner	ø 75x145x51	4711928 4711927 VKHB2203
14	728661	Cuscinetto esterno mozzo / Hub bearing, outer	ø 55x120x45,5	26800610 1905114 VKHB2002
15	730767	Paraolio interno mozzo / Oil seal, inner	ø 125x150x13	40001933 40001930
16	730777	Paraolio interno mozzo / Oil seal, inner	ø 120x140x13	190.32 - 220.32 - 260.32 2475845 4459071
17	729046	Rondella spaccata per colonna / Lockwasher		504023611 1121811

1

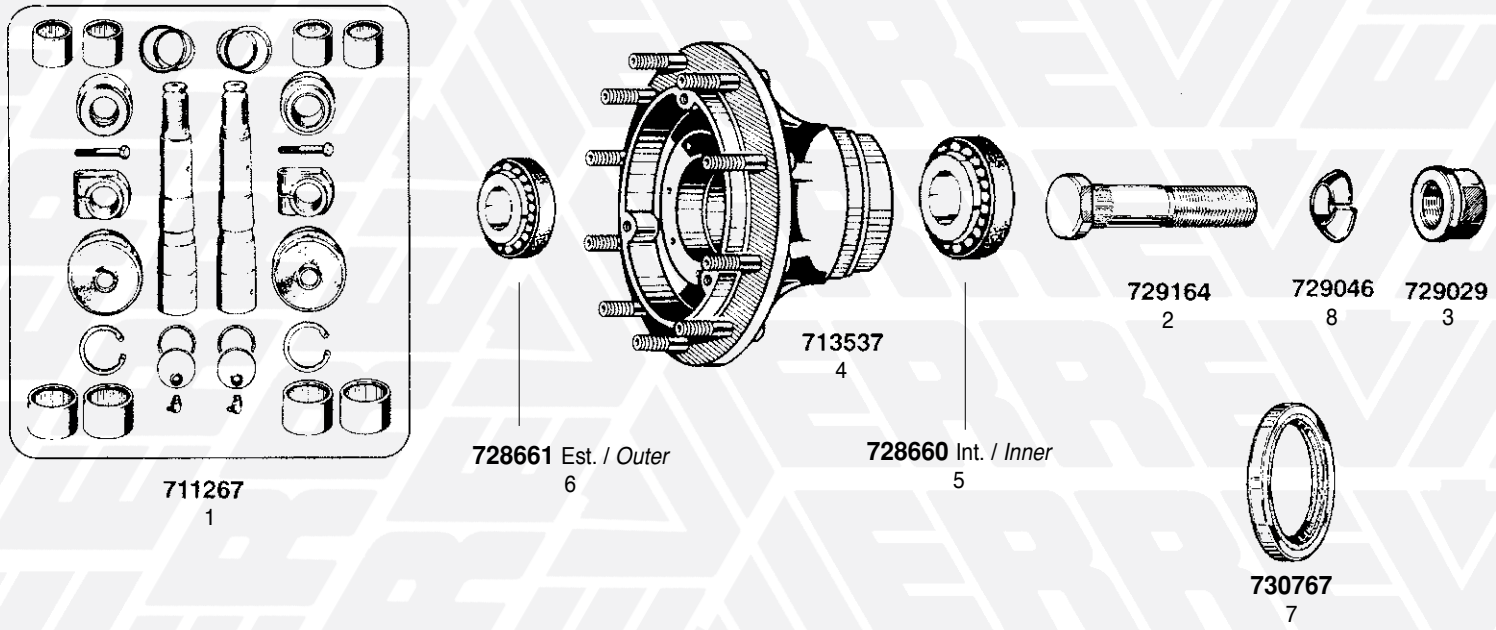

2

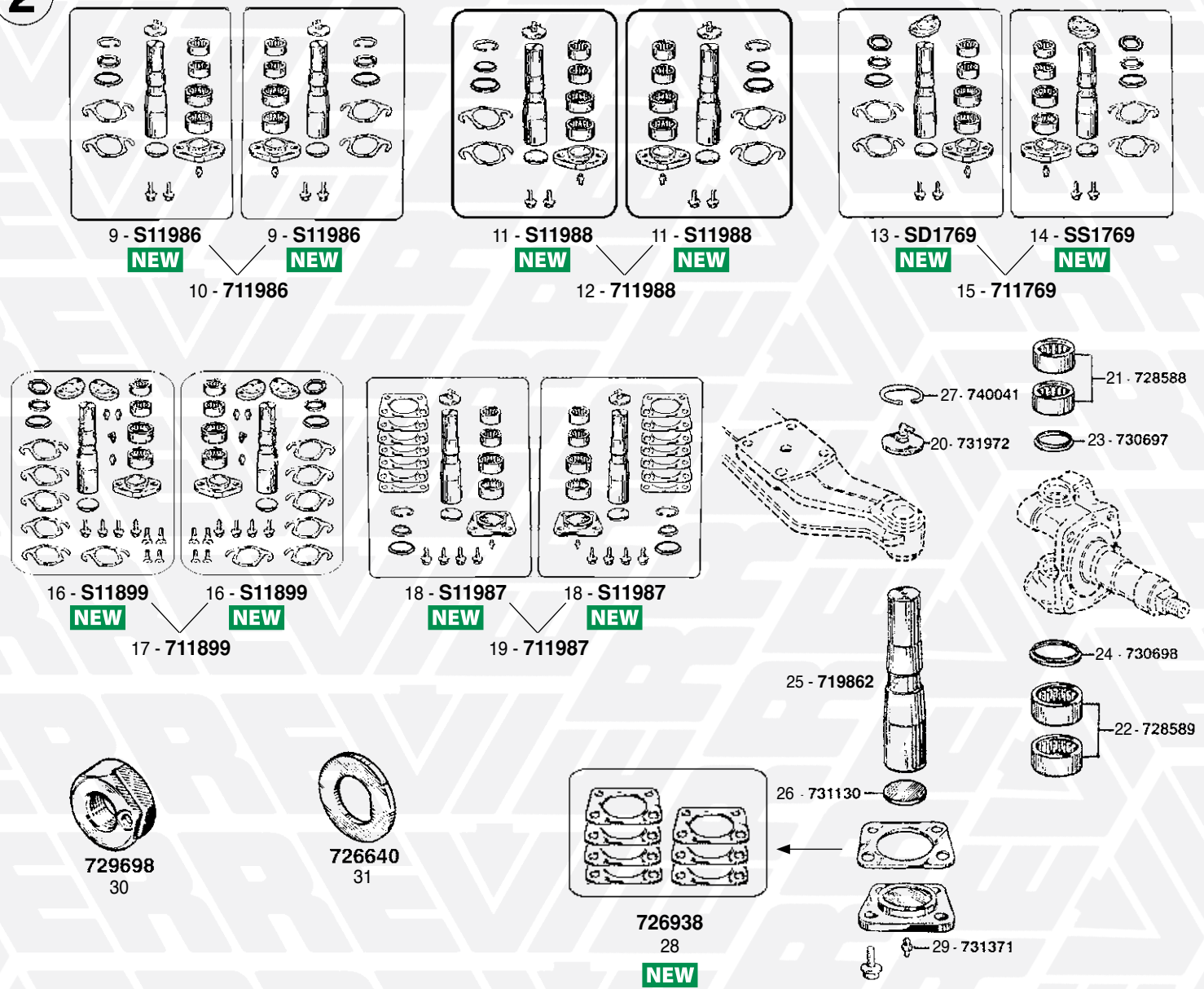
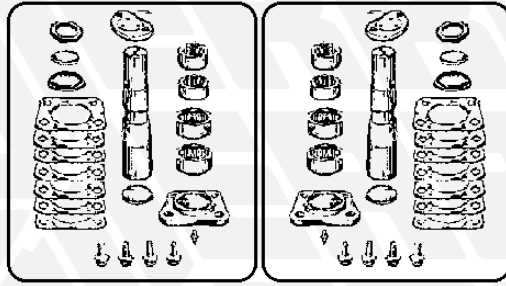

FIG. ITEM	RIF. ERREVI ERREVI REF.	DESCRIZIONE PARTICOLARI DESCRIPTION	TIPO VEHICLE MODEL	RIF. ORIG. ORIG. REF.	
<div style="text-align: center;"> 1 330.26H/ .26HT/ .26N - 330.30H/ .30HT - 330.35H/ .35HT FUSI A SNODO / STEERING KNUCKLES </div>					
1	711267	Complessivo revisione perni fusi (2 RUOTE) con cuscinetti <i>King pin repair kit (Services 2 WHEELS) c/w bearings</i>	Perno / Pin ø 41,3/50,8 L=277	1907840	
MOZZI E RUOTE (VEICOLI CON MOZZI) / HUBS AND WHEELS (VEHICLES WITH HUBS)					
2	729164	Colonna fissaggio ruota - U.TIPO / <i>Wheel stud</i>	M22x1,5 L=81	7168585 7168855 2475870	
3	729029	Dado per colonna / <i>Wheel nut</i>	M22x1,5	41800483	
4	713537	Mozzo ruota compl. di colonnette / <i>Front hub assy</i>		7168586 7162807	
5	728660	Cuscinetto interno mozzo / <i>Hub bearing, inner</i>	ø 75x145x51	4711928 4711927 VKHB2203	
6	728661	Cuscinetto esterno mozzo / <i>Hub bearing, outer</i>	ø 55x120x45,5	26800610 1905114 VKHB2002	
7	730767	Paraolio interno mozzo / <i>Oil seal, inner</i>	ø 125x150x13	40001933 40001930	
8	729046	Rondella spaccata per colonna / <i>Lockwasher</i>		504023611 1121811	
<div style="text-align: center;"> 2 EUROCARGO - EUROCARGO "TECTOR" FUSI A SNODO / STEERING KNUCKLES </div>					
9	S11986	Complessivo revisione perni fusi (1 RUOTA) <i>King pin repair kit (Services 1 WHEEL)</i>	Perno / Pin ø 28/35 L=178	EUROCARGO 60E10/E12/E14 - 65E10/ E12/E14 - 75E12/E14/E15 - 80E15/E18/E21 95E18 - 100E15/E18/E21 - 180E21 E.CARGO "TECTOR" 75E13/E15/E17/E18 100E17/E18/E21	1904696
10	711986	Complessivo revisione perni fusi (2 RUOTE) <i>King pin repair kit (Services 2 WHEELS)</i>			
11	S11988	Complessivo revisione perni fusi (1 RUOTA) <i>King pin repair kit (Services 1 WHEEL)</i>	Perno / Pin ø 35/43 L=199	EUROCARGO 120E15/E18/E23 - 130E15/E18/E23 150E15/E18/E23/E27 - 260E23-280E23-320E27 E.CARGO "TECTOR" 130E18/E24/E28 150E18/E24/E28-320E28T	1904697
12	711988	Complessivo revisione perni fusi (2 RUOTE) <i>King pin repair kit (Services 2 WHEELS)</i>			
13	SD1769	Complessivo revisione perni fusi Dx (1 RUOTA) <i>King pin repair kit RH (Services 1 WHEEL)</i>	Perno / Pin ø 33/40 L=175	130EL15 / EL18 / EL21	42470862
14	SS1769	Complessivo revisione perni fusi Sx (1 RUOTA) <i>King pin repair kit LH (Services 1 WHEEL)</i>	Perno / Pin ø 33/40 L=175	130EL15 / EL18 / EL21	42470863
15	711769	Complessivo revisione perni fusi (2 RUOTE) <i>King pin repair kit (Services 2 WHEELS)</i>		130EL15 / EL18 / EL21	42470862 42470863
16	S11899	Complessivo revisione perni fusi (1 RUOTA) <i>King pin repair kit (Services 1 WHEEL)</i>	Perno / Pin ø 35/43 L=199	EUROCARGO "TECTOR"	2995709 2995710
17	711899	Complessivo revisione perni fusi (2 RUOTE) <i>King pin repair kit (Services 2 WHEELS)</i>			
18	S11987	Complessivo revisione perni fusi (1 RUOTA) <i>King pin repair kit (Services 1 WHEEL)</i>	Perno / Pin ø 43/53 L=224,5	EUROCARGO 150E15H/E18H 170E15/E18/E23/E27 - 260E23KE/E27KE E.CARGO "TECTOR" 180E21/E24/E28 - 260E28KE	1904698 2992185
19	711987	Complessivo revisione perni fusi (2 RUOTE) composto da: <i>King pin repair kit (Services 2 WHEELS) complete with:</i>			
20	731972	(2) Coperchio sup. fuso c/guarnizione / <i>Upper cover</i> (2) Coperchio inf. perno fuso / <i>Lower cover</i>			7172857 -
21	728588	(4) Gabbia a rulli sup. e inf. fuso / <i>Roller cage</i>			7172874
22	728589	(4) Gabbia a rulli inf. fuso / <i>Roller cage, bottom</i>			7172971
23	730697	(2) Paraolio sup. e inf. fuso / <i>Oil seal</i>			40101061
24	730698	(2) Paraolio inf. fuso / <i>Oil seal, bottom</i>			40101031
25	719862	(2) Perno fuso / <i>King pin</i>	ø 43/53x225		-
26	731130	(2) Ralla inf. perno fuso / <i>Thrust plate</i>	ø 52		7172939
27	740041	(2) Seeger sup. fuso / <i>Circlip</i>			16873476 11060576
28	726938	(1) Kit spessori di registro - 7 pz. / <i>Shim set - 7 pcs.</i>			7173025 7173021 7173309
29	731371	(2) Ingrassatore / <i>Grease nipple</i> (8) Bullone / <i>Bolt</i>	M10x1 M12x30		1120694 -
30	729698	Dado fuso / <i>Cover nut</i>			7173068
31	726640	Rondella per dado fuso / <i>Flat washer</i>			7173075

1



1 - SD1770
NEW
2 - SS1770
NEW
3 - 711770

2

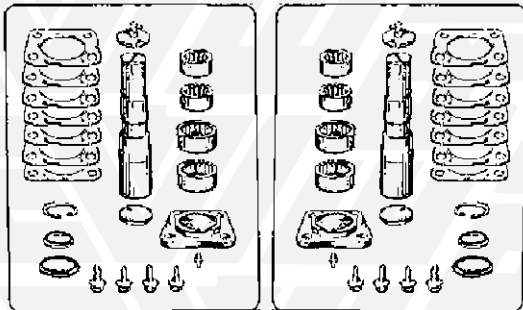

4 - S11987
NEW
4 - S11987
NEW
5 - 711987

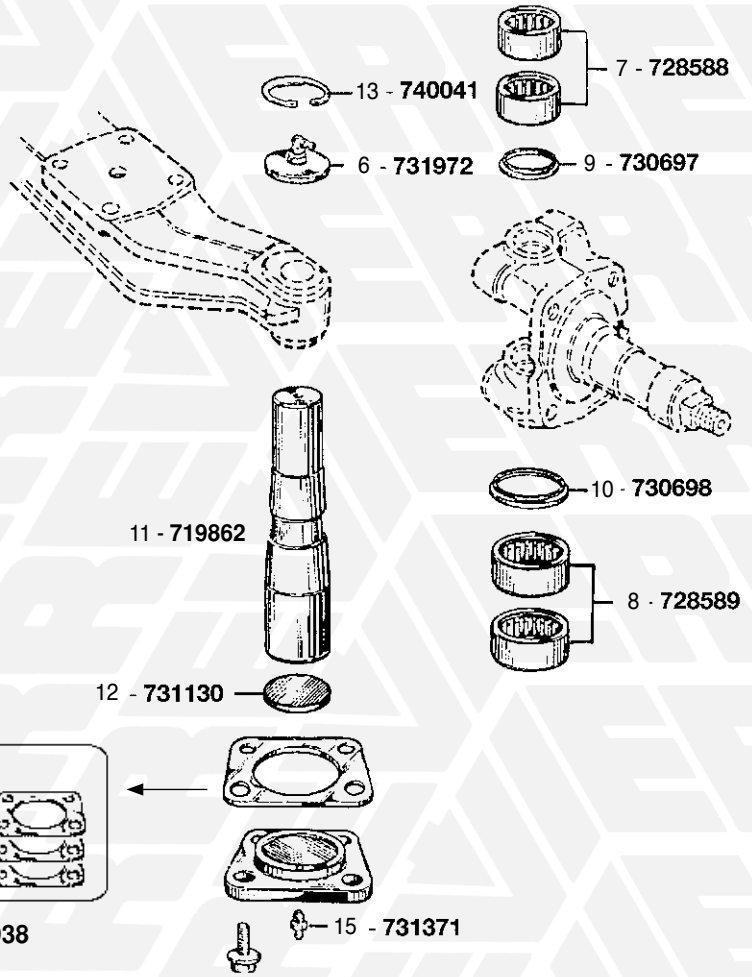

FIG. ITEM	RIF. ERREVI ERREVI REF.	DESCRIZIONE PARTICOLARI DESCRIPTION	TIPO VEHICLE MODEL	RIF. ORIG. ORIG. REF.
<div style="display: flex; align-items: center;"> <div style="font-size: 2em; margin-right: 10px;">1</div> <div> <p>EUROCARGO 170 E18 / E23 / E27 - 260 E27KE EUROTECH "CURSOR" 440 E39 / E43 EUROSTAR "CURSOR" 440 E39 / E43</p> <p>FUSI A SNODO / STEERING KNUCKLES</p> </div> </div>				
1	SD1770	Complessivo revisione perni fusi Dx (1 RUOTA) <i>King pin repair kit RH (Services 1 WHEEL)</i>	Perno / Pin ø 43/53 L=225	42471013
2	SS1770	Complessivo revisione perni fusi Sx (1 RUOTA) <i>King pin repair kit LH (Services 1 WHEEL)</i>	Perno / Pin ø 43/53 L=225	42471014
3	711770	Complessivo revisione perni fusi (2 RUOTE) <i>King pin repair kit (Services 2 WHEELS)</i>		42471013 42471014
<div style="display: flex; align-items: center;"> <div style="font-size: 2em; margin-right: 10px;">2</div> <div> <p>EUROTECH - EUROTECH "CURSOR" EUROSTAR - EUROSTAR "CURSOR" EUROTRAKKER - EUROTRAKKER "CURSOR" STRALIS</p> <p>FUSI A SNODO / STEERING KNUCKLES</p> </div> </div>				
4	S11987	Complessivo revisione perni fusi (1 RUOTA) <i>King pin repair kit (Services 1 WHEEL)</i>	Perno / Pin ø 43/53 L=224,5	1904698 2992185
5	711987	Complessivo revisione perni fusi (2 RUOTE) <i>King pin repair kit (Services 2 WHEELS)</i> composto da: / complete with:		
6	731972	(2) Coperchio sup. perno fuso c/guarnizione / <i>Upper cover</i> (2) Coperchio inf. fuso / <i>Lower cover</i>		7172857 -
7	728588	(4) Gabbia a rulli sup. fuso / <i>Roller cage, top</i>		7172874
8	728589	(4) Gabbia a rulli inf. fuso / <i>Roller cage, bottom</i>		7172971
9	730697	(2) Paraolio sup. fuso / <i>Oil seal, top</i>		40101061
10	730698	(2) Paraolio inf. fuso / <i>Oil seal, bottom</i>		40101031
11	719862	(2) Perno fuso / <i>King pin</i>	ø 43/53x225	-
12	731130	(2) Ralla inf. fuso / <i>Thrust plate</i>	ø 52	7172939
13	740041	(2) Seeger sup. fuso / <i>Circlip</i>		16873476
14	726938	(1) Kit spessori di registro - 7 pz. / <i>Shim set - 7 pcs.</i>		7173025 7173021 7173309
15	731371	(2) Ingrassatore / <i>Grease nipple</i> (8) Bulloni / <i>Bolt</i>	M10x1	1120694 -

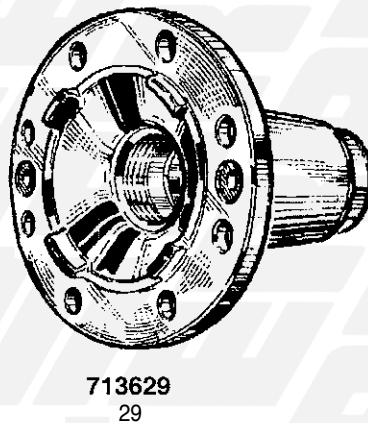
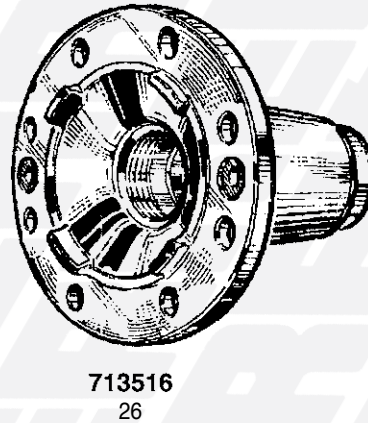
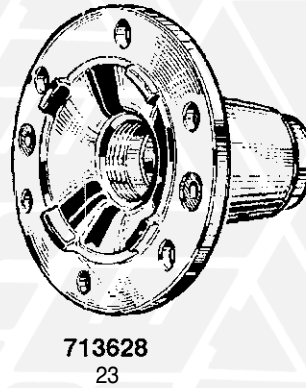
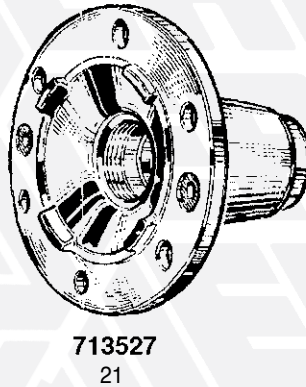
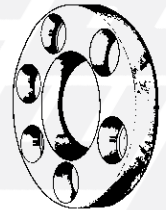
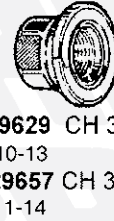
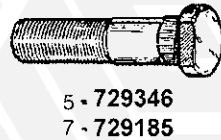
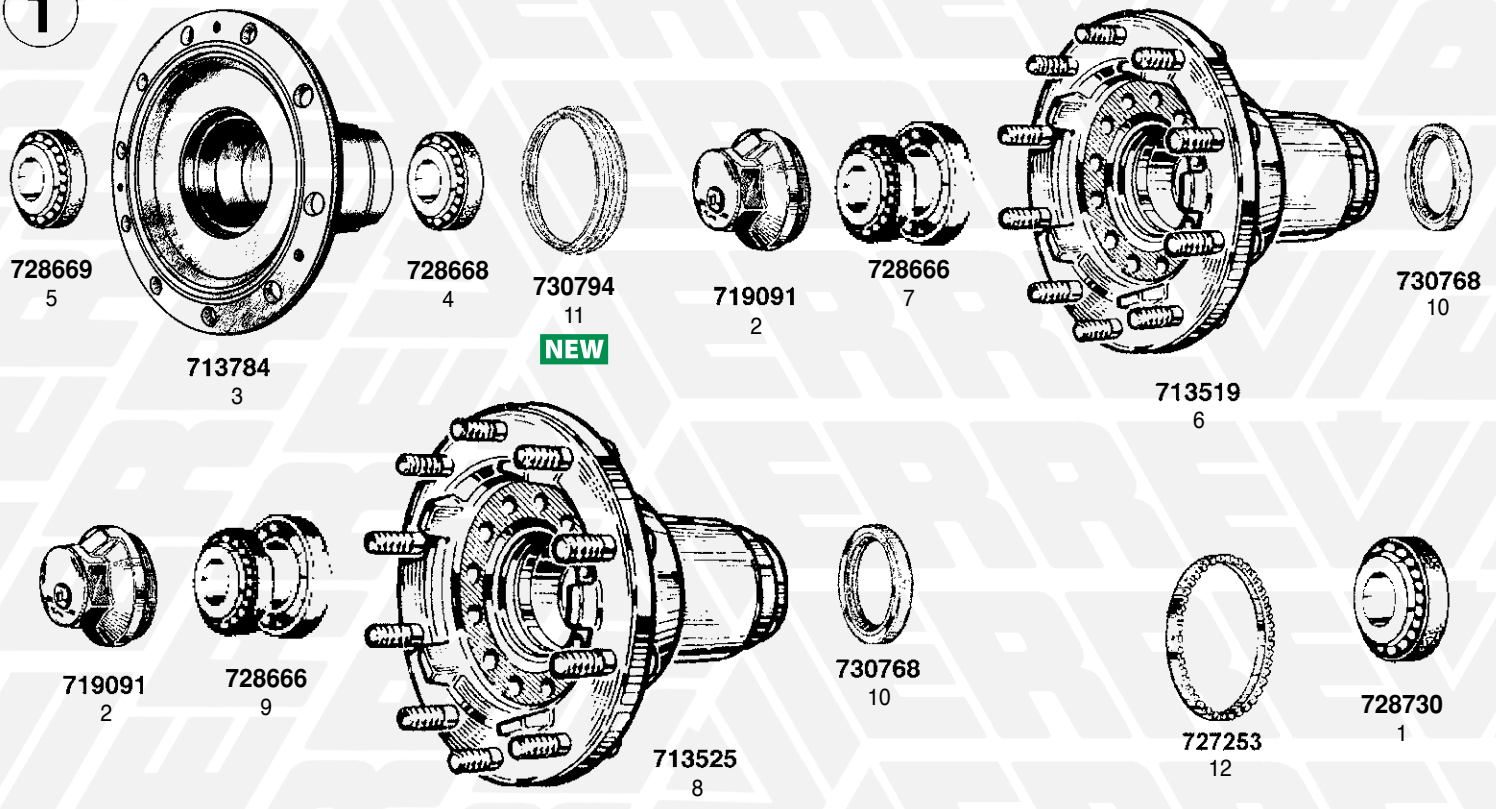

FIG. ITEM	RIF. ERREVI ERREVI REF.	DESCRIZIONE PARTICOLARI DESCRIPTION	TIPO VEHICLE MODEL	RIF. ORIG. ORIG. REF.
EUROCARGO				
MOZZI E RUOTE / HUBS AND WHEELS				
1	719087	Calotta coprimozzo (completa di tappo) / <i>Hub cap</i>	M80x2 60E10/E12/E14 - 65E10/E12/E14 75E12/E14/E15 - 80E15/E18/E21	7184092 7179170 7182427
2	719091	Calotta coprimozzo (completa di tappo) / <i>Hub cap</i>	M125x2	7184091
3	729149	Colonna fiss. ruota / <i>Wheel stud</i>	M18x1,5 L=65	42117463 46390478 7168257
4	729626	Dado per colonna / <i>Wheel nut</i>	M18x1,5	4459602 7168838
5	729346	Colonna fiss. ruota / <i>Wheel stud</i>	M20x1,5 L=70	42117433 7168838
6	729028	Dado per colonna / <i>Wheel nut</i>	M20x1,5	4803810 99474403 2476979
7	729185	Colonna fiss. ruota / <i>Wheel stud</i>	M20x1,5 L=77	7170510
8	729028	Dado per colonna / <i>Wheel nut</i>	M20x1,5	4803810 2476979
9	729177	Colonna fiss. ruota / <i>Wheel stud</i>	M22x1,5 L=77	42064821 42116737 42117448
10	729629	Dado per colonna 1ª Serie / <i>Wheel nut</i>	M22x1,5 H31	4803809 4459603
11	729657	Dado per colonna U.T. / <i>Wheel nut</i>	M22x1,5 H27	41031725
12	729356	Colonna fiss. ruota / <i>Wheel stud</i>	M22x1,5 L=64	42064819 42064818
13	729629	Dado per colonna 1ª Serie / <i>Wheel nut</i>	M22x1,5 H31	4459603
14	729657	Dado per colonna U.T. / <i>Wheel nut</i>	M22x1,5 H27	41031725 99474402
15	729802	Dado con guida per colonna / <i>Wheel nut</i>	M22x1,5 H tot. 33 mm	-
16	729691	Dado c/guida per colonna / <i>Wheel nut</i>	M22x1,5 H tot. 39,5 mm	41035863 41032670
17	733401	Copertura protezione ruote / <i>Wheel cover</i>	ø est. 270 mm	60-65E10/E12/E14 - 75E12/E14/E15 99477376
18	733402	Copertura protezione ruote / <i>Wheel cover</i>	ø est. 350 mm	80E15/E18/E21 - 100E15/E18/E21 320E27 - 120E15/E18/E21H/E23 130E15/E18/E23 - 150E15/E18/E23 180E2 - 260/280E23 500316950
19	733403	Copertura protezione ruote / <i>Wheel cover</i>	ø est. 410 mm	170E15/E18/E23/E27 41027912
20	733404	Copertura protezione ruote / <i>Wheel cover</i>	ø est. 420 mm	170E15/E18/E23/E27 41032687
21	713527	Mozzo ruota, nudo / <i>Wheel hub, bare</i>	60E10/E12-E14 65E10/E12/E14 - 75E12/E14/E15	7173047
22	728664	Cuscinetto interno ed esterno mozzo / <i>Hub bearing</i>	ø 45x75x20	1905221 VKHB2250
23	713628	Mozzo ruota, nudo / <i>Wheel hub, bare</i>	65E14 - 75E12/E14/E15	7177134
24	728664	Cuscinetto interno ed esterno mozzo / <i>Hub bearing</i>	ø 45x75x20	1905221 VKHB2250
25	728665	Cuscinetto interno ed esterno mozzo / <i>Hub bearing</i>	ø 45x85x34	1905222 VKHB2249
26	713516	Mozzo ruota, nudo / <i>Wheel hub, bare</i>	80E15/E18/E21-85E15H/E18/E18H 100E15/E18/E21 - 95E18 - 180E21	7173747
27	728664	Cuscinetto interno ed esterno mozzo / <i>Hub bearing</i>	ø 45x75x20	1905221 VKHB2250
28	728665	Cuscinetto interno ed esterno mozzo / <i>Hub bearing</i>	ø 45x85x34	1905222 VKHB2249
29	713629	Mozzo ruota, nudo / <i>Wheel hub, bare</i>	120E15/E15H/E18/E18H/E21H/E23 130E15/E18/E23 - 260E23	7182046 7172885
30	728667	Cuscinetto interno ed esterno mozzo / <i>Hub bearing</i>	ø 55x100x35	1905236 VKHB2339
31	730738	Paraolio interno mozzo/ <i>Oil seal, inner</i>	ø 70x90x12	40100483 40002630
32	730766	Paraolio interno mozzo in VITON / <i>Oil seal, inner (VITON material)</i>	ø 80x110x13	40102303 40102301

1



2

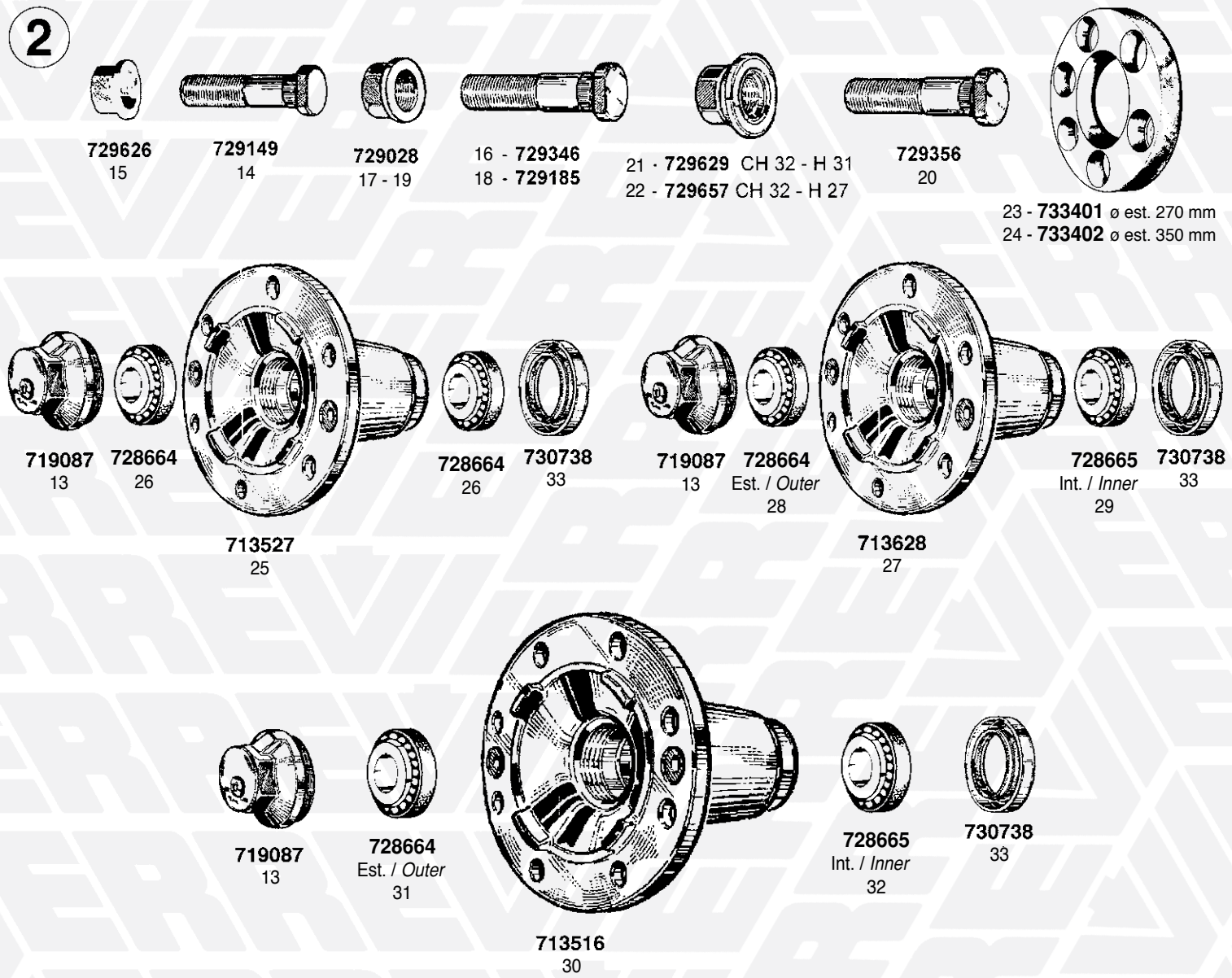
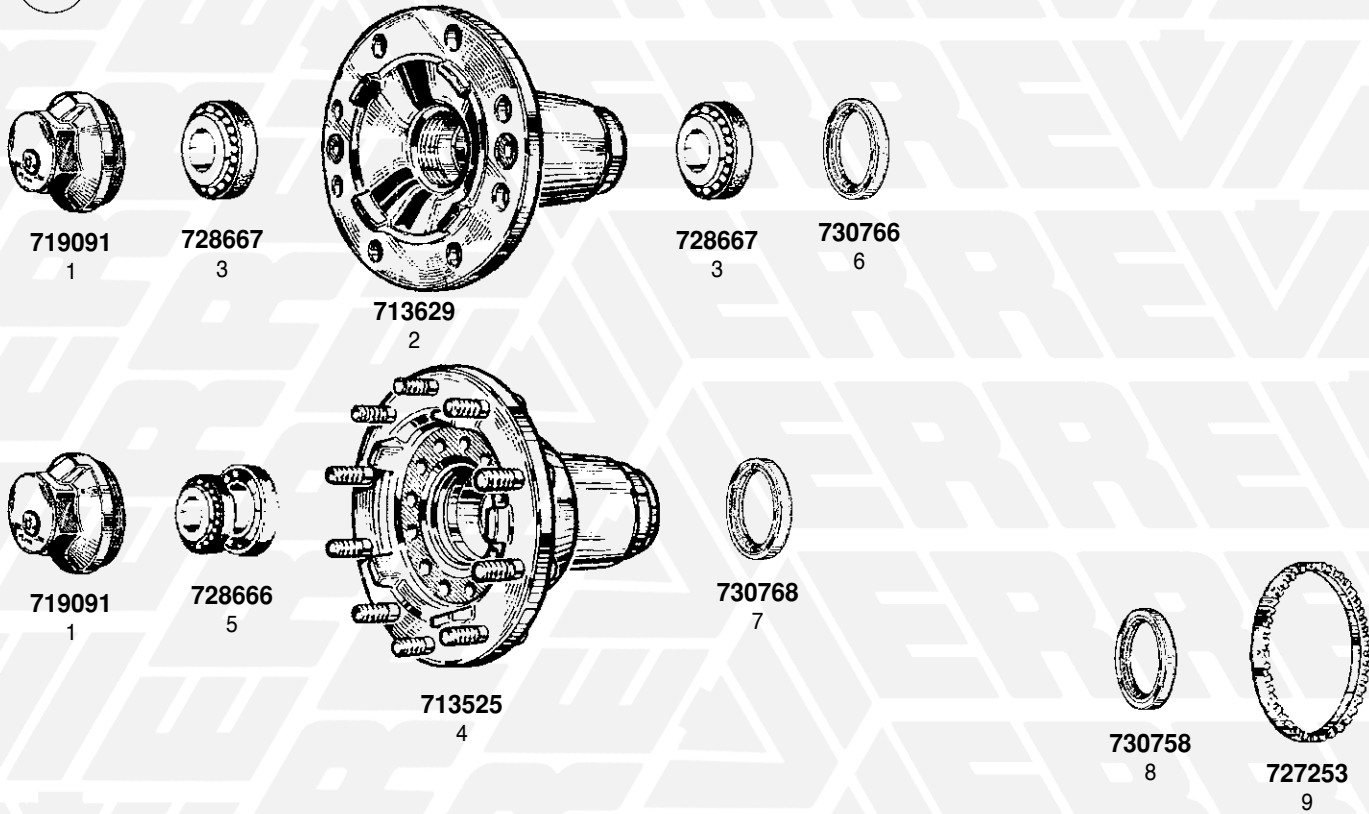

FIG. ITEM	RIF. ERREVI / ERREVI REF.	DESCRIZIONE PARTICOLARI / DESCRIPTION		TIPO / VEHICLE MODEL	RIF. ORIG. / ORIG. REF.
<div style="text-align: center;"> 1 Segue / Cont'd: EUROCARGO MOZZI E RUOTE / HUBS AND WHEELS </div>					
1	728730	Cuscinetto interno ed esterno mozzo / <i>Hub bearing</i>	∅ 50x90x32	120EL15/EL18/EL21	7181852 1905492 33210 VKHB2068
2	719091	Calotta coprimozzo (completa di tappo) / <i>Hub cap</i>	M125x2		7184091
3	713784	Mozzo ruota, nudo / <i>Wheel hub, bare</i>		135E18/E21/E23	42115016
4	728668	Cuscinetto interno mozzo / <i>Hub bearing, inner</i>	∅ 95x145x39	135E18/E21/E23	1104923 VKHB2082
5	728669	Cuscinetto esterno mozzo / <i>Hub bearing, outer</i>	∅ 105x160x35	135E18/E21/E23	1104922 VKHB2160
6	713519	Mozzo ruota con colonnette / <i>Wheel hub c/w studs</i>		170E15/E18/E23/E27 260E23KE/E27KE	7173314 7173315
7	728666	Cuscinetto interno ed esterno mozzo / <i>Hub bearing</i>	∅ 70x120x37	170E15/E18/E23/E27 260E23KE/E27KE	1905273 VKHB5343
8	713525	Mozzo ruota con colonnette / <i>Wheel hub c/w studs</i>		170E18/E23/E27-260E27KE	7180797 7183906 7188706
9	728666	Cuscinetto interno ed esterno mozzo / <i>Hub bearing</i>	∅ 70x120x37	170E15/E18/E23/E27 260E23KE/E27KE	1905273 VKHB5343
10	730768	Paraolio interno mozzo in VITON / <i>Oil seal, inner (VITON material)</i>	∅ 95x130x16	170E15/E18/E23/E27 260E23KE/E27KE	7185250 40102143
11	730794	Paraolio interno mozzo / <i>Oil seal</i>	∅ 128x144/152x11/26	135E18/E21/E23	40102103 40101123
12	727253	Ruota fonica / <i>Impulse wheel</i>	∅ 142x148x15		7172934
<div style="text-align: center;"> 2 EUROCARGO "TECTOR" MOZZI E RUOTE / HUBS AND WHEELS </div>					
13	719087	Calotta coprimozzo (completa di tappo) / <i>Hub cap</i>	M80x2	75E13/E15/E17/E18 100E17/E18/E21	7184092 7179170 7182427
14	729149	Colonna fiss. ruota / <i>Wheel stud</i>	M18x1,5 L=65	75E13/E15/E17/E18	42117463 46390478 7168257
15	729626	Dado per colonna / <i>Wheel nut</i>	M18x1,5		4459602
16	729346	Colonna fiss. ruota / <i>Wheel stud</i>	M20x1,5 L=70	100E17/E18/E21-120E17/E21	42117433 7168838
17	729028	Dado per colonna / <i>Wheel nut</i>	M20x1,5		4803810 99474403 2476979
18	729185	Colonna fiss. ruota / <i>Wheel stud</i>	M20x1,5 L=77	130E18/E24/E28 150E18/E24/E28 320E28T	7170510 42117434 42064829 42117435
19	729028	Dado per colonna / <i>Wheel nut</i>	M20x1,5		4803810 99474403 2476979
20	729356	Colonna fiss. ruota / <i>Wheel stud</i>	M22x1,5 L=64	180E21/E24/E28 - 260E28KE	42064819 42064818
21	729629	Dado per colonna 1ª Serie/ <i>Wheel nut</i>	M22x1,5 H31		4459603
22	729657	Dado per colonna U.T. / <i>Wheel nut</i>	M22x1,5 H27		41031725 99474402
23	733401	Copertura protezione ruote / <i>Wheel cover</i>	∅ est. 270 mm	75E13/E15/E17	99477376
24	733402	Copertura protezione ruote / <i>Wheel cover</i>	∅ est. 350 mm	100E17/E18/E21 - 130E18/E21/E24 140E18/E21 - 150E18/E21	500316950
25	713527	Mozzo ruota, nudo / <i>Wheel hub, bare</i>		75E13/E15/E17/E18	7173047
26	728664	Cuscinetto interno ed esterno mozzo / <i>Hub bearing</i>	∅ 45x75x20	75E15/E17/E18 - 100E17/E18/E21	1905221 VKHB2250
27	713628	Mozzo ruota, nudo / <i>Wheel hub, bare</i>		75E13/E15/E17/E18	7177134
28	728664	Cuscinetto interno ed esterno mozzo / <i>Hub bearing</i>	∅ 45x75x20	75E15/E17/E18 - 100E17/E18/E21	1905221 VKHB2250
29	728665	Cuscinetto interno ed esterno mozzo / <i>Hub bearing</i>	∅ 45x85x34	75E15/E17/E18 - 100E17/E18/E21	1905222 VKHB2249
30	713516	Mozzo ruota, nudo / <i>Wheel hub, bare</i>		100E17/E18/E21	7173747
31	728664	Cuscinetto interno ed esterno mozzo / <i>Hub bearing</i>	∅ 45x75x20	75E15/E17/E18 - 100E17/E18/E21	1905221 VKHB2250
32	728665	Cuscinetto interno ed esterno mozzo / <i>Hub bearing</i>	∅ 45x85x34	75E15/E17/E18 - 100E17/E18/E21	1905222 VKHB2249
33	730738	Paraolio interno mozzo / <i>Oil seal</i>	∅ 70x90x12		40100483 40002630

1



2

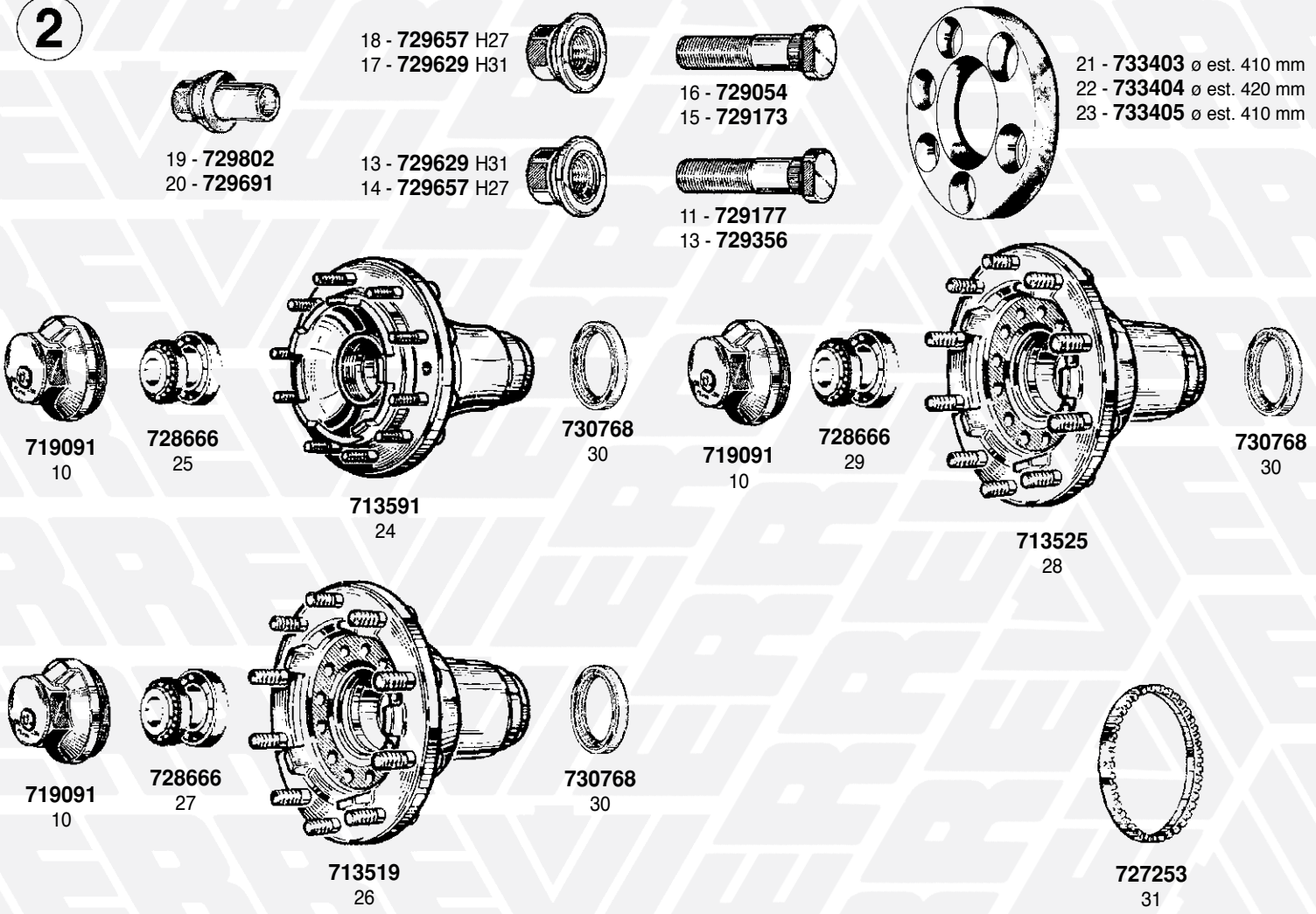
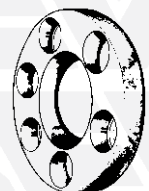

FIG. ITEM	RIF. ERREVI ERREVI REF.	DESCRIZIONE PARTICOLARI DESCRIPTION	TIPO VEHICLE MODEL	RIF. ORIG. ORIG. REF.	
<div style="text-align: center;"> 1 Segue / Cont'd: EURO CARGO "TECTOR" MOZZI E RUOTE / HUBS AND WHEELS </div>					
1	719091	Calotta coprimozzo (completa di tappo) / Hub cap	M125x2	7184091	
2	713629	Mozzo ruota, nudo / Wheel hub, bare		7182046 7172885	
3	728667	Cuscinetto interno ed esterno mozzo / Hub bearing	ø 55x100x35	130E18/E24/E28 150E18/E21/E24/E28 - 325E28T	1905236 VKHB2339
4	713525	Mozzo ruota con colonnette / Wheel hub c/w studs		180E21/E24/E28 - 260E28KE	7180797 7183906 7188706
5	728666	Cuscinetto interno ed esterno mozzo / Hub bearing	ø 70x120x37	180E21/E24/E28 - 260E28KE	1905273 VKHB5343
6	730766	Paraolio interno mozzo in VITON / Oil seal, inner (VITON material)	ø 80x110x13	130E18/E24/E28 150E18/E21/E24/E28 - 325E28T	40102303 40102301
7	730768	Paraolio interno mozzo in VITON / Oil seal, inner (VITON material)	ø 95x130x16	180E21/E24/E28 - 260E28KE	7185250 40102143
8	730758	Paraolio interno mozzo / Oil seal	ø 95x130x16	180E21/E24/E28 - 260E28KE	40100463 40100040
9	727253	Ruota fonica / Impulse wheel	ø 142x148x15		7172934
<div style="text-align: center;"> 2 EUROTECH - EUROTECH "CURSOR" - EUROSTAR - EUROSTAR "CURSOR" MOZZI E RUOTE / HUBS AND WHEELS </div>					
10	719091	Calotta coprimozzo (completa di tappo) / Hub cap	M125x2	7184091	
11	729177	Colonna fiss. ruota 1ª Serie / Wheel stud	M22x1,5 L=77	EUROTECH - EUROSTAR	42117448 42064821 42116737
12	729356	Colonna fiss. ruota U.T. / Wheel stud	M22x1,5 L=64		42064818 42064819
13	729629	Dado per colonna 1ª Serie / Wheel nut	M22x1,5 H 31	EUROTECH - EUROSTAR	4459603
14	729657	Dado per colonna U.T. / Wheel nut	M22x1,5 H 27		41031725 41298921
15	729173	Colonna fiss. ruota 1ª Serie / Wheel stud	M22x1,5 L=90		42117452
16	729054	Colonna fiss. ruota U.T. / Wheel stud	M22x1,5 L=86		42117451 42119444
17	729629	Dado per colonna 1ª Serie / Wheel nut	M22x1,5 H 31		4459603
18	729657	Dado per colonna U.T. / Wheel nut	M22x1,5 H 27		41031725 41299921
19	729802	Dado con guida per colonna / Wheel nut	M22x1,5 H tot. 33 mm		-
20	729691	Dado c/guida per colonna / Wheel nut	M22x1,5 H tot. 38,5 mm		41035863 41036368
21	733403	Copertura protezione ruote / Wheel cover	ø est. 410 mm		41027912
22	733404	Copertura protezione ruote / Wheel cover	ø est. 420 mm	EUROTECH - EUROSTAR	41032687
23	733405	Copertura protezione ruote / Wheel cover	ø est. 410 mm		41027910
24	713591	Mozzo ruota completo di colonnette - senza ruota fonica - Hub c/w studs		EUROTECH - EUROSTAR EUROTECH "CURSOR" 190E24/E31/ E35 - 260E24/E31/E35 260E39/E34 EUROSTAR "CURSOR" 260E39/E43/E48	7182031 7182032 7173326 7173327
25	728666	Cuscinetto interno ed esterno mozzo / Hub bearing	ø 70x120x37		1905273 VKHB5343
26	713519	Mozzo ruota completo di colonnette / Wheel hub c/w studs		EUROTECH 180E24/E27/E30/E34 190E24/E27/E30 - 325E27 400E30/E34/E38 EUROSTAR 400E38/E42	7173314 7173315
27	728666	Cuscinetto interno ed esterno mozzo / Hub bearing	ø 70x120x37		1905273 VKHB5343
28	713525	Mozzo ruota con colonnette / Wheel hub c/w studs			7180797 7183906 7188706
29	728666	Cuscinetto interno ed esterno mozzo / Hub bearing	ø 70x120x37		1905273 VKHB5343
30	730768	Paraolio interno mozzo in VITON / Oil seal (VITON material)	ø 95x130x16		7185250 40102143
31	727253	Ruota fonica / Impulse wheel	ø 142x148x15		7172934

1

5 - 729657 H 27
4 - 729629 H 31

3 - 729054
2 - 729173



6 - 733404 ø est. 420 mm
7 - 733405 ø est. 410 mm

719091
1

728666
9

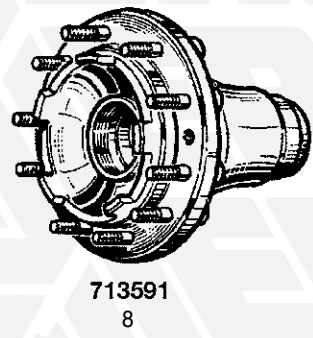

730768
13

728669
12

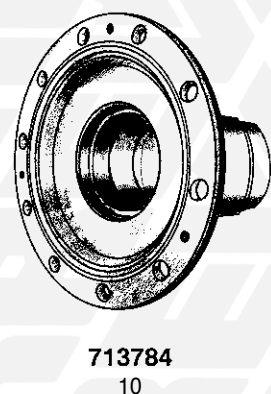

728668
11



730794
14
NEW

727253
15

2

18 - 729629 H 31
20 - 729657 H 27

19 - 729054
17 - 729173

23 - 729802
24 - 729691

729657 H 27
22

729356
21

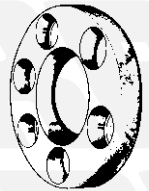

6 - 733404 ø est. 420 mm
7 - 733405 ø est. 410 mm

719091
16

728666
28

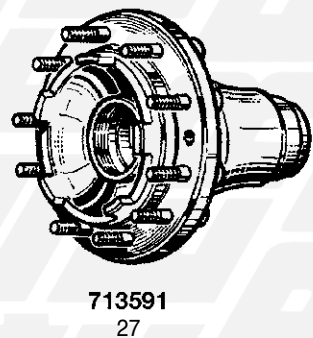

730768
31

719091
16

728666
30

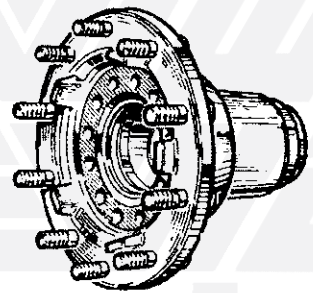

730768
31



730794
32
NEW

727253
33

713525
29

FIG. ITEM	RIF. ERREVI ERREVI REF.	DESCRIZIONE PARTICOLARI DESCRIPTION	TIPO VEHICLE MODEL	RIF. ORIG. ORIG. REF.	
<div style="text-align: center;"> 1 EUROTRAKKER - TRAKKER MOZZI E RUOTE / HUBS AND WHEELS </div>					
1	719091	Calotta coprimozzo (completa di tappo) / <i>Hub cap</i>	M125x2	7184091	
2	729173	Colonna fiss. ruota 1ª Serie / <i>Wheel stud</i>	M22x1,5 L=90	42117452	
3	729054	Colonna fiss. ruota U.T. / <i>Wheel stud</i>	M22x1,5 L=86	42117451 42119444	
4	729629	Dado per colonna 1ª Serie / <i>Wheel nut</i>	M22x1,5 H 31	4459603 42117503	
5	729657	Dado per colonna U.T. / <i>Wheel nut</i>	M22x1,5 H 27	41031725 41299921	
6	733404	Copertura protezione ruote / <i>Wheel cover</i>	∅ est. 420 mm	41032687	
7	733405	Copertura protezione ruote / <i>Wheel cover</i>	∅ est. 410 mm	41027910	
8	713591	Mozzo ruota completo di colonnette - senza ruota fonica - <i>Hub c/w studs</i>		7182031/32 7173326/27	
9	728666	Cuscinetto interno ed esterno mozzo / <i>Hub bearing</i>	∅ 70x120x37	1905273 VKHB5343	
10	713784	Mozzo ruota, nudo / <i>Wheel hub, bare</i>		42115016	
11	728668	Cuscinetto interno mozzo / <i>Hub bearing, inner</i>	∅ 95x145x39	1104923 VKHB2082	
12	728669	Cuscinetto esterno mozzo / <i>Hub bearing, outer</i>	∅ 105x160x35	1104922 VKHB2160	
13	730768	Paraolio interno mozzo in VITON / <i>Oil seal (VITON material)</i>	∅ 95x130x16	7185250 40102143	
14	730794	Paraolio interno mozzo / <i>Oil seal</i>	∅ 128x144/152x11/26	EUROTRAKKER 190E31/E37/E38 340E42-380E42-410E42 TRAKKER 380T44 - 720T44	40102103 40101123
15	727253	Ruota fonica / <i>Impulse wheel</i>	∅ 142x148x15	7172934	
<div style="text-align: center;"> 2 EUROTRAKKER "CURSOR" MOZZI E RUOTE / HUBS AND WHEELS </div>					
16	719091	Calotta coprimozzo (completa di tappo) / <i>Hub cap</i>	M125x2	7184091	
17	729173	Colonna fiss. ruota / <i>Wheel stud</i>	M22x1,5 L=90	42117452	
18	729629	Dado per colonna / <i>Wheel nut</i>	M22x1,5 H 31	4459603	
19	729054	Colonna fiss. ruota / <i>Wheel stud</i>	M22x1,5 L=86	42117451 42119444	
20	729657	Dado per colonna / <i>Wheel nut</i>	M22x1,5 H 27	41031725 41299921	
21	729356	Colonna fiss. ruota / <i>Wheel stud</i>	M22x1,5 L=64	42064819 42064818	
22	729657	Dado per colonna / <i>Wheel nut</i>	M22x1,5 H 27	41031725 41299921	
23	729802	Dado con guida per colonna / <i>Wheel nut</i>	M22x1,5 H tot. 33 mm	-	
24	729691	Dado c/guida per colonna / <i>Wheel nut</i>	M22x1,5 H tot. 38 mm	41036368	
25	733404	Copertura protezione ruote / <i>Wheel cover</i>	∅ est. 420 mm	41032687	
26	733405	Copertura protezione ruote / <i>Wheel cover</i>	∅ est. 410 mm	41027910	
27	713591	Mozzo ruota completo di colonnette - senza ruota fonica - <i>Hub c/w studs</i>		7182031/32 7173326/27	
28	728666	Cuscinetto interno ed esterno mozzo / <i>Hub bearing</i>	∅ 70x120x37	1905273 VKHB5343	
29	713525	Mozzo ruota con colonnette / <i>Wheel hub c/w studs</i>		7180797 7183906 7188706	
30	728666	Cuscinetto interno ed esterno mozzo / <i>Hub bearing</i>	∅ 70x120x37	1905273 VKHB5343	
31	730768	Paraolio interno mozzo in VITON / <i>Oil seal (VITON material)</i>	∅ 95x130x16	7185250 40102143	
32	730794	Paraolio interno mozzo / <i>Oil seal</i>	∅ 128x144/152x11/26	190E38 - 380E38 - 720E44	40102103 40101123
33	727253	Ruota fonica / <i>Impulse wheel</i>	∅ 142x148x15	7172934	

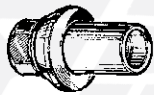

6 - 729802
7 - 729691

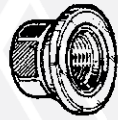

729657
5



729054
4

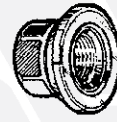

729657
3



729356
2



719091
1



728666
11

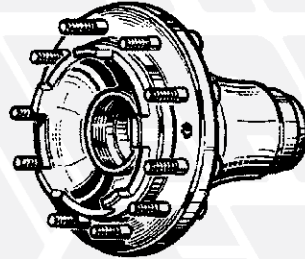

713591
10



730768
14

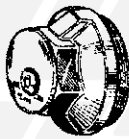

719091
1



728666
13

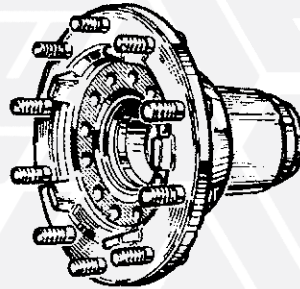

713525
12



730768
14



8 - 733403 \varnothing est. 410 mm
9 - 733404 \varnothing est. 420 mm



727253
15

FIG. ITEM	RIF. ERREVI ERREVI REF.	DESCRIZIONE PARTICOLARI DESCRIPTION	TIPO VEHICLE MODEL	RIF. ORIG. ORIG. REF.
STRALIS				
MOZZI E RUOTE / HUBS AND WHEELS				
1	719091	Calotta coprimozzo (completa di tappo) / <i>Hub cap</i>	M125x2 U.T.	7184091
2	729356	Colonna fiss. ruota / <i>Wheel stud</i>	M22x1,5 L=64	260S40/S48-440S40/S43/S44/S54 42064818 42064819
3	729657	Dado per colonna / <i>Wheel nut</i>	M22x1,5 H 27	41031725 41299921
4	729054	Colonna fiss. ruota / <i>Wheel stud</i>	M22x1,5 L=86	260S40/S43/S48 42117451 42119444
5	729657	Dado per colonna / <i>Wheel nut</i>	M22x1,5 H 27	41031725 41299921
6	729802	Dado con guida per colonna / <i>Wheel nut</i>	M22x1,5 H tot. 33 mm	-
7	729691	Dado c/guida per colonna / <i>Wheel nut</i>	M22x1,5 H tot. 38 mm	41036368
8	733403	Copertura protezione ruote / <i>Wheel cover</i>	ø est. 410 mm	41027912
9	733404	Copertura protezione ruote / <i>Wheel cover</i>	ø est. 420 mm	41032687
10	713591	Mozzo ruota completo di colonnette - senza ruota fonica <i>Hub c/w studs</i>	260S40/S43/S48	7182031 7182032 7173326 7173327
11	728666	Cuscinetto interno ed esterno mozzo / <i>Hub bearing</i>	ø 70x120x37	1905273 VKHB5343
12	713525	Mozzo ruota con colonnette / <i>Wheel hub c/w studs</i>		7180797 7183906 7188706
13	728666	Cuscinetto interno ed esterno mozzo / <i>Hub bearing</i>	ø 70x120x37	1905273 VKHB5343
14	730768	Paraolio interno mozzo in VITON / <i>Oil seal (VITON material)</i>	ø 95x130x16	7185250 40102143
15	727253	Ruota fonica / <i>Impulse wheel</i>	ø 142x148x15	7172934

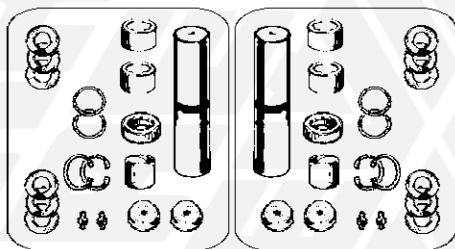

1 - S11828
NEW 1 - S11828
NEW
2 - 711828

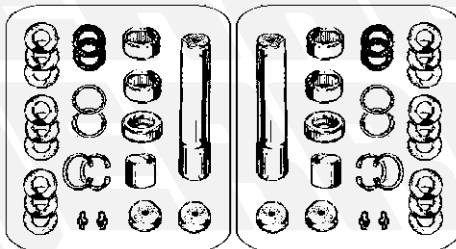

3 - S11744
NEW 3 - S11744
NEW
4 - 711744

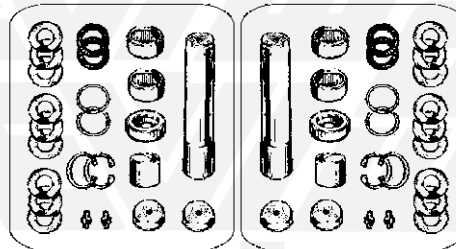

5 - S11743
NEW 5 - S11743
NEW
6 - 711743

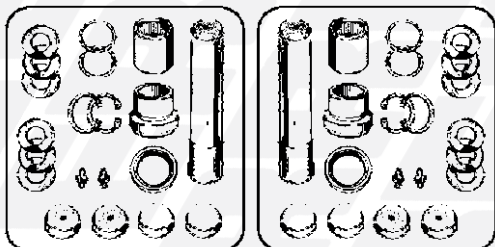

7 - S11742
NEW 7 - S11742
NEW
8 - 711742

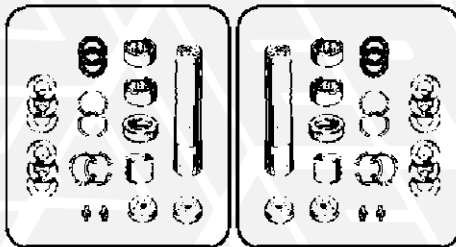

9 - S11781
NEW 9 - S11781
NEW
10 - 711781

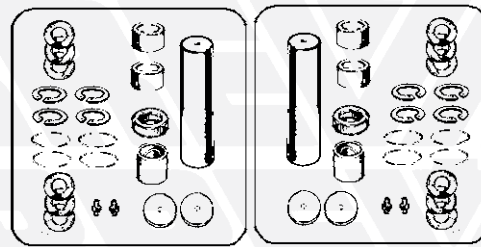

11 - S11827
NEW 11 - S11827
NEW
12 - 711827

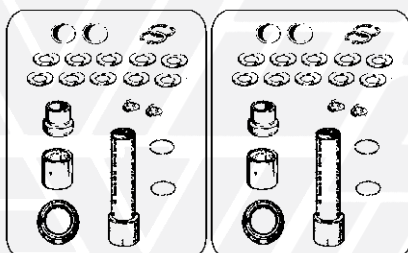

13 - S11820
NEW 13 - S11820
NEW
14 - 711820

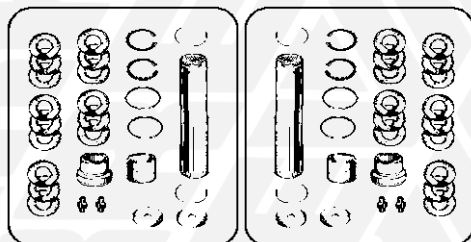

15 - S11829
NEW 15 - S11829
NEW
16 - 711829

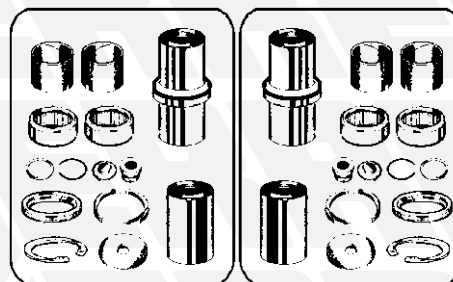

17 - S11824
NEW 17 - S11824
NEW
18 - 711824

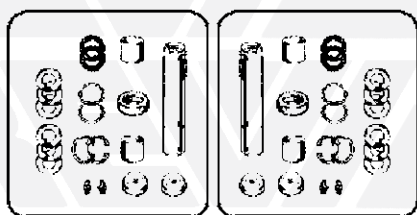

19 - S11784
NEW 19 - S11784
NEW
20 - 711784

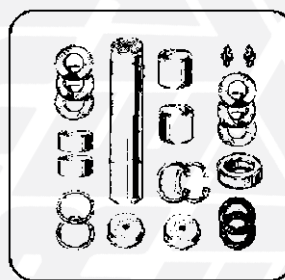

21 - S11979
NEW



22 - S11101
NEW

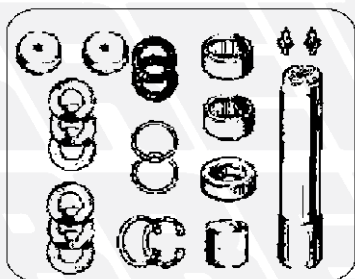

23 - S11103
NEW

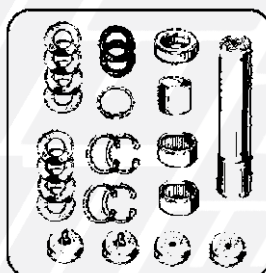

24 - S11110
NEW

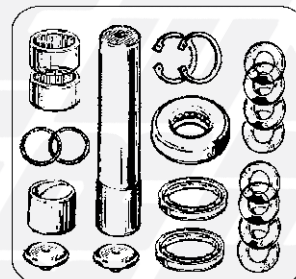

25 - S11113
NEW

FIG. ITEM	RIF. ERREVI ERREVI REF.	DESCRIZIONE PARTICOLARI DESCRIPTION	TIPO VEHICLE MODEL	RIF. ORIG. ORIG. REF.
MAN				
FUSI A SNODO / STEERING KNUCKLES				
1	S11828	Complessivo revisione perni fusi (1 RUOTA) <i>King pin repair kit (Services 1 WHEEL)</i>	Perno / Pin ø 34,5/35 L=174	G90 81442056016
2	711828	Complessivo revisione perni fusi (2 RUOTE) <i>King pin repair kit (Services 2 WHEELS)</i>		
3	S11744	Complessivo revisione perni fusi (1 RUOTA) <i>King pin repair kit (Services 1 WHEEL)</i>	Perno / Pin ø 49,5/50 L=223	M90 - F90 - M2000 - F2000 81442056013
4	711744	Complessivo revisione perni fusi (2 RUOTE) <i>King pin repair kit (Services 2 WHEELS)</i>		
5	S11743	Complessivo revisione perni fusi (1 RUOTA) <i>King pin repair kit (Services 1 WHEEL)</i>	Perno / Pin ø 50/51 L=224	M2000 - F2000 81442056023
6	711743	Complessivo revisione perni fusi (2 RUOTE) <i>King pin repair kit (Services 2 WHEELS)</i>		
7	S11742	Complessivo revisione perni fusi (1 RUOTA) <i>King pin repair kit (Services 1 WHEEL)</i>	Perno / Pin ø 52/53 L=235	F2000 - TGA - F90 - G90 - M90 L2000 - M2000 81442056030
8	711742	Complessivo revisione perni fusi (2 RUOTE) <i>King pin repair kit (Services 2 WHEELS)</i>		
9	S11781	Complessivo revisione perni fusi (1 RUOTA) <i>King pin repair kit (Services 1 WHEEL)</i>	Perno / Pin ø 35/36 L=172	L2000 - M2000 81442056025
10	711781	Complessivo revisione perni fusi (2 RUOTE) <i>King pin repair kit (Services 2 WHEELS)</i>		
11	S11827	Complessivo revisione perni fusi (1 RUOTA) <i>King pin repair kit (Services 1 WHEEL)</i>	Perno / Pin ø 29/30 L=156	L2000 81442056024 81442056017
12	711827	Complessivo revisione perni fusi (2 RUOTE) <i>King pin repair kit (Services 2 WHEELS)</i>		
13	S11820	Complessivo revisione perni fusi (1 RUOTA) <i>King pin repair kit (Services 1 WHEEL)</i>	Perno / Pin ø 38/39 L=173	L2000 - TGL 81442056033
14	711820	Complessivo revisione perni fusi (2 RUOTE) <i>King pin repair kit (Services 2 WHEELS)</i>		
15	S11829	Complessivo revisione perni fusi (1 RUOTA) <i>King pin repair kit (Services 1 WHEEL)</i>	Perno / Pin ø 43 L=200	TGM 81442056034
16	711829	Complessivo revisione perni fusi (2 RUOTE) <i>King pin repair kit (Services 2 WHEELS)</i>		
17	S11824	Complessivo revisione perni fusi (1 RUOTA) <i>King pin repair kit (Services 1 WHEEL)</i>	Perno / Pin ø 50/64 L=109/119	TGA - TGM - TGS - F90 - F2000 M90 - M2000 - L2000 81363056004 81363050015 81363050016 81363050014
18	711824	Complessivo revisione perni fusi (2 RUOTE) <i>King pin repair kit (Services 2 WHEELS)</i>		
19	S11784	Complessivo revisione perni fusi (1 RUOTA) <i>King pin repair kit (Services 1 WHEEL)</i>	Perno / Pin ø 49,5/50 L=223	BUS 81442056010
20	711784	Complessivo revisione perni fusi (2 RUOTE) <i>King pin repair kit (Services 2 WHEELS)</i>		
21	S11979	Complessivo revisione perni fusi (1 RUOTA) <i>King pin repair kit (Services 1 WHEEL)</i>	Perno / Pin ø 44,5/45 L=213	M90 81442056009
22	S11101	Complessivo revisione perni fusi (1 RUOTA) <i>King pin repair kit (Services 1 WHEEL)</i>	Perno / Pin ø 34/34,5 L=173	G90 81442056012
23	S11103	Complessivo revisione perni fusi (1 RUOTA) <i>King pin repair kit (Services 1 WHEEL)</i>	Perno / Pin ø 34,5/35 L=174	L2000 81442056020
24	S11110	Complessivo revisione perni fusi (1 RUOTA) <i>King pin repair kit (Services 1 WHEEL)</i>	Perno / Pin ø 41,5/42 L=202	M90 - M2000 81442056019
25	S11113	Complessivo revisione perni fusi (1 RUOTA) <i>King pin repair kit (Services 1 WHEEL)</i>	Perno / Pin ø 42/43 L=200	F2000 - M2000 81442056027



719118
1

NEW



729389
2

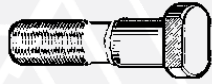

729390
3

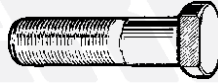

729391
4



729392
5



729025
6



729626
7



729627
8



729831
9



729830
10



729182
11



729029
12



729657
13



729659
14



15 - 728723
16 - 728730



729778
17



729786
18



729776
19

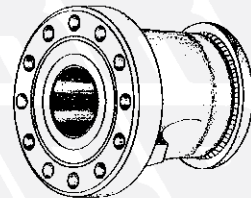

713781
20

FIG. ITEM	RIF. ERREVI ERREVI REF.	DESCRIZIONE PARTICOLARI DESCRIPTION		TIPO VEHICLE MODEL	RIF. ORIG. ORIG. REF.
MOZZI E RUOTE / HUBS AND WHEELS					
1	719118	Calotta coprimozzo / <i>Hub cap</i>	M115x1,5 Ch / Key 65	E2000 - F2000 - F90 - M2000 M90	81443120009
2	729389	Colonna fissaggio ruota / <i>Wheel stud</i>	M18x1,5 L=58	TGL	81455010152 81455010116
3	729390	Colonna fissaggio ruota / <i>Wheel stud</i>	M18x1,5 L=70	TGL	81455010171
4	729391	Colonna fissaggio ruota / <i>Wheel stud</i>	M18x1,5 L=70	L2000	81455010181
5	729392	Colonna fissaggio ruota / <i>Wheel stud</i>	M18x1,5 L=70	L2000	81455010159
6	729025	Dado per colonna / <i>Wheel nut</i>	M18x1,5		-
7	729626	Dado per colonna / <i>Wheel nut</i>	M18x1,5		-
8	729627	Dado per colonna / <i>Wheel nut</i>	M18x1,5		-
9	729831	Colonna fissaggio ruota / <i>Wheel stud</i>	M22x1,5 L=65	E2000 - F2000 - M2000- TGA TGM - TGS - TGX	81455010129
10	729830	Colonna fissaggio ruota / <i>Wheel stud</i>	M22x1,5 L=80	L2000 - M2000 TGA - TGM - TGS - TGX	81455010114 81455010133 81455010163 81455010164 81455010174
11	729182	Colonna fissaggio ruota / <i>Wheel stud</i>	M22x1,5 L=110	F2000 - F90	81455010067 81455010082 81455010141
12	729029	Dado per colonna / <i>Wheel nut</i>	M22x1,5		-
13	729657	Dado per colonna / <i>Wheel nut</i>	M22x1,5		-
14	729659	Dado per colonna / <i>Wheel nut</i>	M22x1,5		-
15	728723	Cuscinetto esterno mozzo / <i>Hub bearing, outer</i>	ø 95x145x32	E2000 - F2000 - F90 - L2000 M2000 - M90 - TGA - TGM - TGS	06324890012 06324890064 06324890114 06324890115 32019XA VKHB2161
16	728730	Cuscinetto esterno mozzo / <i>Hub bearing, outer</i>	ø 50x90x32	Serie SL - SG Series	06324890004 06324890041 81934200072 33210 VKHB2068
17	729778	Ghiera fissaggio mozzo / <i>Axle locking nut</i>	M42x1,5 L=18	TGL	81906200098
18	729786	Dado fissaggio mozzo / <i>Hub nut</i>	M55x1,5	F90 - G90 - M90 TGM - TGL - TGX - TGA - TGS	81906850052 81906850303
19	729776	Ghiera fissaggio mozzo / <i>Axle locking nut</i>	M58x1,5 L=25	E2000 - F2000 - M2000 - TGA TGM - TGS - TGX	81906200086 81906200110
20	713781	Mozzo ruota completo di cuscinetto e ruota fonica <i>Wheel hub assembly</i>		F2000 - E2000 - M2000 TGM - TGX - TGA - TGS	81934200288 81934200330 81934200349

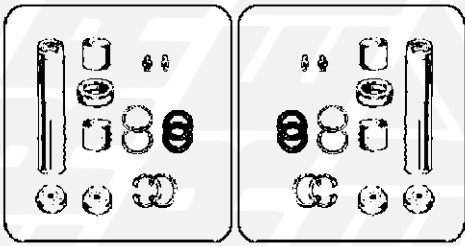

1 - S11783
NEW 1 - S11783
NEW
2 - 711783

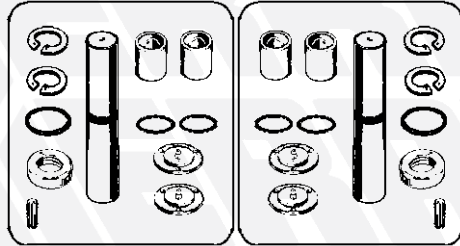

3 - S11816
NEW 3 - S11816
NEW
4 - 711816

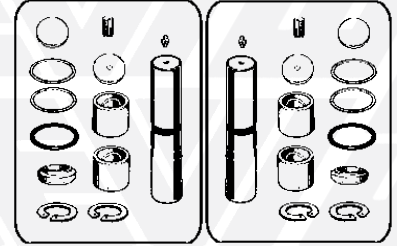

5 - SD1817
NEW 6 - SS1817
NEW
7 - 711817

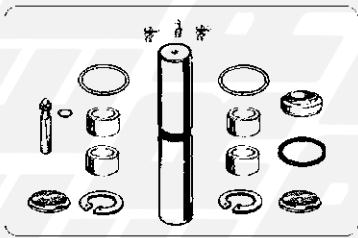

8 - S11977
NEW



9 - S11818
NEW

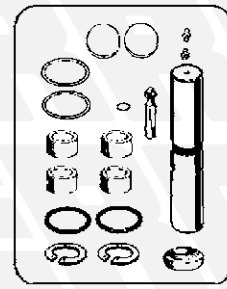

10 - S11819
NEW

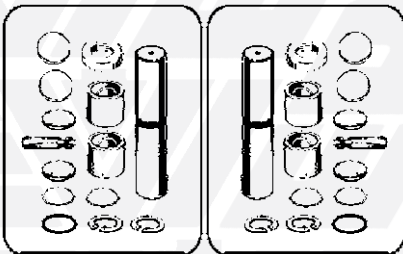

11 - S11773
NEW 11 - S11773
NEW
12 - 711773

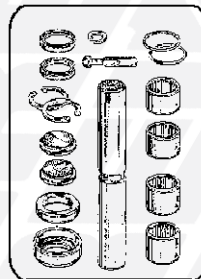

13 - SS1705
NEW

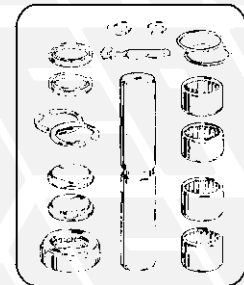

14 - SD1939
NEW

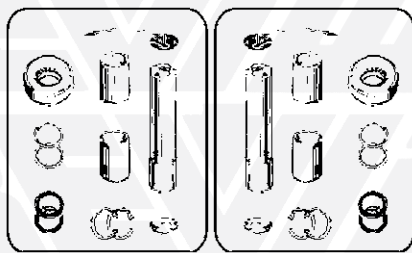

15 - S11325
NEW 15 - S11325
NEW
16 - 711325

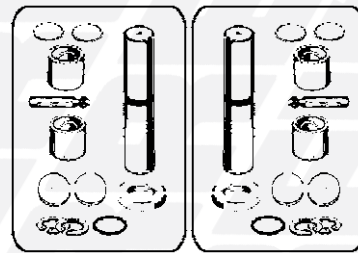

17 - S11774
NEW 17 - S11774
NEW
18 - 711774

FIG. ITEM	RIF. ERREVI ERREVI REF.	DESCRIZIONE PARTICOLARI DESCRIPTION	TIPO VEHICLE MODEL	RIF. ORIG. ORIG. REF.
MERCEDES				
FUSI A SNODO / STEERING KNUCKLES				
1	S11783	Complessivo revisione perni fusi (1 RUOTA) <i>King pin repair kit (Services 1 WHEEL)</i>	Perno / Pin ø 50/51 L=222,5	303 - 305 - 307 3073300019 3075860033
2	711783	Complessivo revisione perni fusi (2 RUOTE) <i>King pin repair kit (Services 2 WHEELS)</i>		
3	S11816	Complessivo revisione perni fusi (1 RUOTA) <i>King pin repair kit (Services 1 WHEEL)</i>	Perno / Pin ø 26 L=136	307D - 308D - 310D - 407D 408D - 410D - 507D - 510 - 512D SPRINTER A6113300019 6113300019
4	711816	Complessivo revisione perni fusi (2 RUOTE) <i>King pin repair kit (Services 2 WHEELS)</i>		
5	SD1817	Complessivo revisione perni fusi Dx (1 RUOTA) <i>King pin repair kit RH (Services 1 WHEEL)</i>	Perno / Pin ø 26 L=136	307D - 308D - 310D - 407D 408D - 410D - 507D - 510 - 512D SPRINTER A6113300319 6113300319
6	SS1817	Complessivo revisione perni fusi Sx (1 RUOTA) <i>King pin repair kit LH (Services 1 WHEEL)</i>	Perno / Pin ø 26 L=136	307D - 308D - 310D - 407D 408D - 410D - 507D - 510 - 512D SPRINTER A6113300419 6113300419
7	711817	Complessivo revisione perni fusi (2 RUOTE) <i>King pin repair kit (Services 2 WHEELS)</i>		307D - 308D - 310D - 407D 408D - 410D - 507D - 510 - 512D SPRINTER A6113300319 6113300319 A6113300419 6113300419
8	S11977	Complessivo revisione perni fusi (1 RUOTA) <i>King pin repair kit (Services 1 WHEEL)</i>	Perno / Pin ø 27 L=153,5	VARIO 6683300019 3103301219
9	S11818	Complessivo revisione perni fusi (1 RUOTA) <i>King pin repair kit (Services 1 WHEEL)</i>	Perno / Pin ø 30 L=186	VARIO A6703300119 6703300119 A6753300119 6753300119
10	S11819	Complessivo revisione perni fusi (1 RUOTA) <i>King pin repair kit (Services 1 WHEEL)</i>	Perno / Pin ø 30 L=186	VARIO A6703300219 6703300219 A6753300019 6753300019
11	S11773	Complessivo revisione perni fusi (1 RUOTA) <i>King pin repair kit (Services 1 WHEEL)</i>	Perno / Pin ø 36,65 L=211	810 - 911 - 1113 - 1313 - 1513 3603300719 3605860233
12	711773	Complessivo revisione perni fusi (2 RUOTE) <i>King pin repair kit (Services 2 WHEELS)</i>		
13	SS1705	Complessivo revisione perni fusi Sx (1 RUOTA) <i>King pin repair kit LH (Services 1 WHEEL)</i>	Perno / Pin ø 33 L=186	814 - 817 - 914 - 1114 - 1117 - 1120 BUS 6753300319 6753301519
14	SD1939	Complessivo revisione perni fusi Dx (1 RUOTA) <i>King pin repair kit RH (Services 1 WHEEL)</i>	Perno / Pin ø 33 L=186	814 - 817 - 914 - 1114 - 1117 - 1120 BUS 6753300219 6753301419
15	S11325	Complessivo revisione perni fusi (1 RUOTA) <i>King pin repair kit (Services 1 WHEEL)</i>	Perno / Pin ø 50/51 L=223	1013-1213-1413-1613-2026-2626 3913300019 3915860033
16	711325	Complessivo revisione perni fusi (2 RUOTE) <i>King pin repair kit (Services 2 WHEELS)</i>		
17	S11774	Complessivo revisione perni fusi (1 RUOTA) <i>King pin repair kit (Services 1 WHEEL)</i>	Perno / Pin ø 45 L=219	1219 - 1419 - 1619 - 2224 - 2425 BUS 3553300319 3555860033
18	711774	Complessivo revisione perni fusi (2 RUOTE) <i>King pin repair kit (Services 2 WHEELS)</i>		

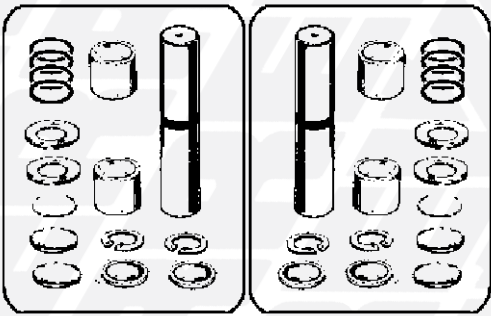

1 - S11775
NEW 1 - S11775
NEW
2 - 711775

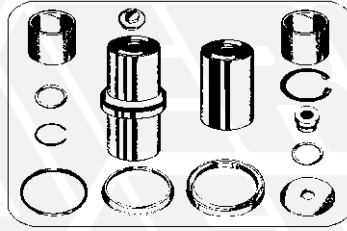

3 - S11797
NEW

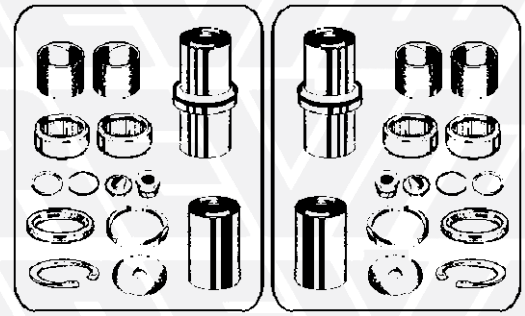

4 - S11824
NEW 4 - S11824
NEW
5 - 711824

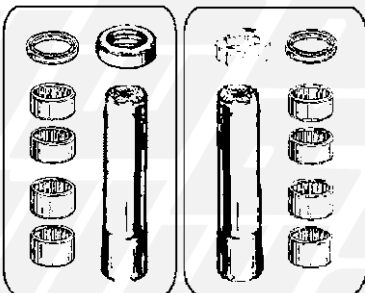

6 - SD1748
NEW 7 - SS1748
NEW
8 - 711748

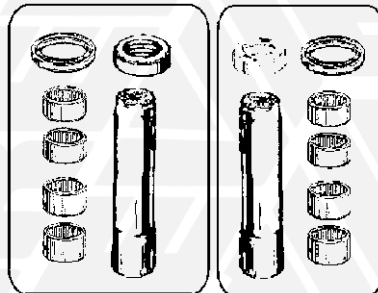

9 - SD1749
NEW 10 - SS1749
NEW
11 - 711749

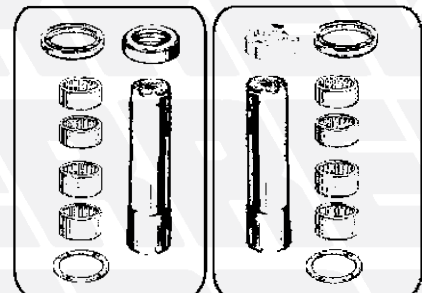

12 - SD1762
NEW 13 - SS1762
NEW
14 - 711762

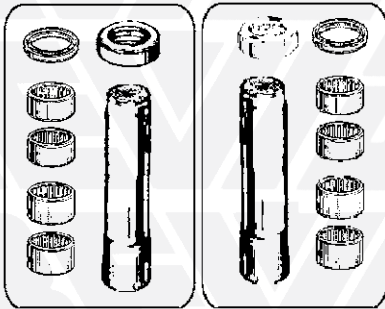

15 - SD1732
NEW 16 - SS1732
NEW
17 - 711732

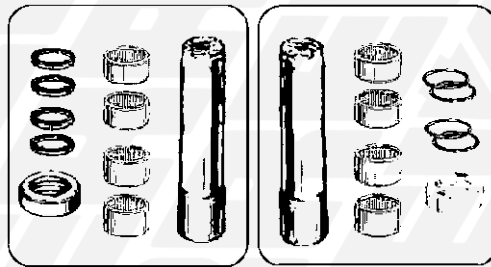

18 - SD1776
NEW 19 - SS1776
NEW
20 - 711776

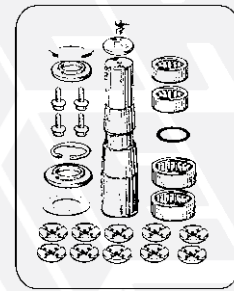

21 - S11115
NEW

FIG. ITEM	RIF. ERREVI ERREVI REF.	DESCRIZIONE PARTICOLARI DESCRIPTION		TIPO VEHICLE MODEL	RIF. ORIG. ORIG. REF.
FUSI A SNODO / STEERING KNUCKLES					
1	S11775	Compressivo revisione perni fusi (1 RUOTA) King pin repair kit (Services 1 WHEEL)	Perno / Pin ø 45/46 L=225	1619 - 1632 - 1928 - 2024 - 2226	3433300219 3435860233
2	711775	Compressivo revisione perni fusi (2 RUOTE) King pin repair kit (Services 2 WHEELS)			
3	S11797	Compressivo revisione perni fusi (1 RUOTA) King pin repair kit (Services 1 WHEEL)	Perno / Pin ø 55 L=109 ø 55/60 L=126	ATEGO - AXOR 2 - ACTROS ACTROS MP2 - ACTROS MP3	6253300119 6253300419
4	S11824	Compressivo revisione perni fusi (1 RUOTA) King pin repair kit (Services 1 WHEEL)	Perno / Pin ø 50/64 L=109/119	Serie NG - SK Series ATEGO - AXOR 2 ACTROS - ACTROS MP2	3463300019 3463300119 3463320106 3463320206 3465860033 3465860133
5	711824	Compressivo revisione perni fusi (2 RUOTE) King pin repair kit (Services 2 WHEELS)			
6	SD1748	Compressivo revisione perni fusi Dx (1 RUOTA) King pin repair kit RH (Services 1 WHEEL)	Perno / Pin ø 50 L=222	ACTROS - ACTROS MP2 ATEGO - AXOR	6553300619
7	SS1748	Compressivo revisione perni fusi Sx (1 RUOTA) King pin repair kit LH (Services 1 WHEEL)	Perno / Pin ø 50 L=222	ACTROS - ACTROS MP2 ATEGO - AXOR	6553300719
8	711748	Compressivo revisione perni fusi (2 RUOTE) King pin repair kit (Services 2 WHEELS)		ACTROS - ACTROS MP2 ATEGO - AXOR	6553300619 6553300719
9	SD1749	Compressivo revisione perni fusi Dx (1 RUOTA) King pin repair kit RH (Services 1 WHEEL)	Perno / Pin ø 50 L=222	ACTROS - ACTROS MP2 ATEGO - AXOR	6553300419
10	SS1749	Compressivo revisione perni fusi Sx (1 RUOTA) King pin repair kit LH (Services 1 WHEEL)	Perno / Pin ø 50 L=222	ACTROS - ACTROS MP2 ATEGO - AXOR	6553300519
11	711749	Compressivo revisione perni fusi (2 RUOTE) King pin repair kit (Services 2 WHEELS)		ACTROS - ACTROS MP2 ATEGO - AXOR	6553300419 6553300519
12	SD1762	Compressivo revisione perni fusi Dx (1 RUOTA) King pin repair kit RH (Services 1 WHEEL)	Perno / Pin ø 54 L=222,5	ACTROS - ACTROS MP2 ATEGO - AXOR	9423300419
13	SS1762	Compressivo revisione perni fusi Sx (1 RUOTA) King pin repair kit LH (Services 1 WHEEL)	Perno / Pin ø 54 L=222,5	ACTROS - ACTROS MP2 ATEGO - AXOR	9423300519
14	711762	Compressivo revisione perni fusi (2 RUOTE) King pin repair kit (Services 2 WHEELS)		ACTROS - ACTROS MP2 ATEGO - AXOR	9423300419 9423300519
15	SD1732	Compressivo revisione perni fusi Dx (1 RUOTA) King pin repair kit RH (Services 1 WHEEL)	Perno / Pin ø 54 L=237	ACTROS - ACTROS MP2 ATEGO - AXOR	9423300219
16	SS1732	Compressivo revisione perni fusi Sx (1 RUOTA) King pin repair kit LH (Services 1 WHEEL)	Perno / Pin ø 54 L=237	ACTROS - ACTROS MP2 ATEGO - AXOR	9423300319
17	711732	Compressivo revisione perni fusi (2 RUOTE) King pin repair kit (Services 2 WHEELS)		ACTROS - ACTROS MP2 ATEGO - AXOR	9423300219 9423300319
18	SD1776	Compressivo revisione perni fusi Dx (1 RUOTA) King pin repair kit RH (Services 1 WHEEL)	Perno / Pin ø 50 L=222,5	ACTROS - ATEGO - AXOR 2 - BUS	6553300019
19	SS1776	Compressivo revisione perni fusi Sx (1 RUOTA) King pin repair kit LH (Services 1 WHEEL)	Perno / Pin ø 50 L=222,5	ACTROS - ATEGO - AXOR 2 - BUS	6553300119
20	711776	Compressivo revisione perni fusi (2 RUOTE) King pin repair kit (Services 2 WHEELS)	Perno / Pin ø 50 L=222,5	ACTROS - ATEGO - AXOR 2 - BUS	6553300019 6553300119
21	S11115	Compressivo revisione perni fusi (1 RUOTA) King pin repair kit (Services 1 WHEEL)	Perno / Pin ø 35/45 L=209 mm	ATEGO	9723320106

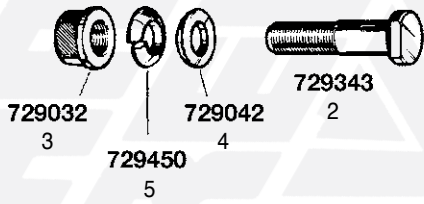

729032 3
729042 4
729450 5
729343 2

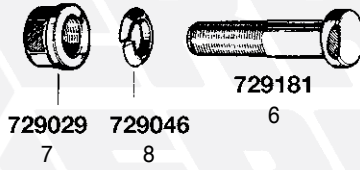

729029 7
729046 8
729181 6

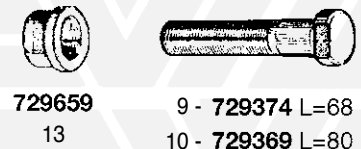

729659 13
9 - 729374 L=68
10 - 729369 L=80
11 - 729364 L=90
12 - 729375 L=110

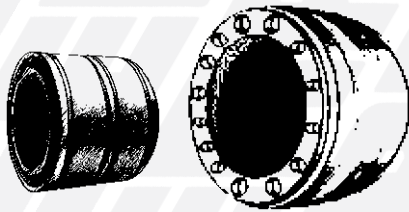

728716 16
713795 15

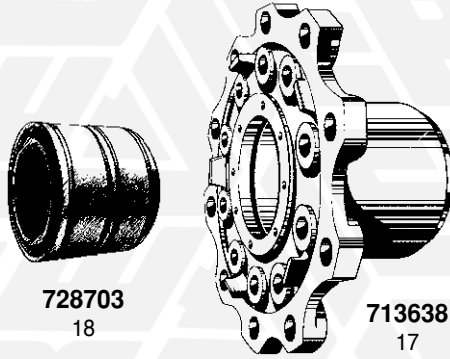

728703 18
713638 17

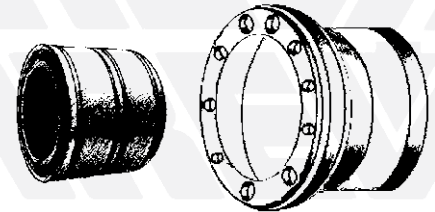

728736 20
713950 19
NEW **NEW**

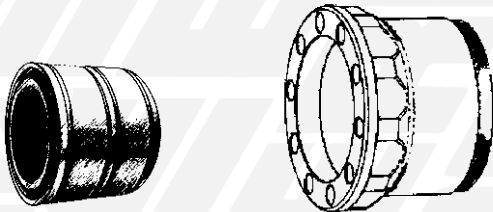

728648 22
713952 21
NEW



728730 23

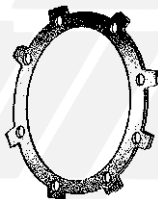

730858 24



727261 25



727294 26
NEW

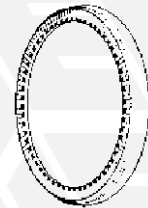

727295 27
NEW

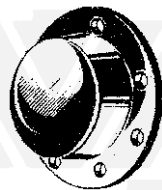

719107 1



729786 14

FIG. ITEM	RIF. ERREVI ERREVI REF.	DESCRIZIONE PARTICOLARI DESCRIPTION		TIPO VEHICLE MODEL	RIF. ORIG. ORIG. REF.
MOZZI E RUOTE / HUBS AND WHEELS					
1	719107	Calotta coprimozzo / <i>Hub cap</i>		ATEGO - AXOR - ACTROS	03273560120 A3273560120
2	729343	Colonna fissaggio ruota / <i>Wheel stud</i>	M20x1,5 L=72	811 - 813 - 913 - 1113 - 1213	3524020171 3124021071
3	729032	Dado per colonna / <i>Wheel nut</i>	M20x1,5	811 - 813 - 913 - 1113 - 1213	74361020205 074361020204
4	729042	Rondella conica per colonna / <i>Cone washer</i>		811 - 813 - 913 - 1113 - 1213	664020075
5	729450	Rondella spaccata per colonna / <i>Lockwasher</i>		811 - 813 - 913 - 1113 - 1213	74361020352
6	729181	Colonna fissaggio ruota / <i>Wheel stud</i>	M22x1,5 L=80	1013-1213-1413-1613-2026-2626	3894010071 3274010471 3274010271 3814010171 3174010471 3174010371 3054010071 3814010271
7	729029	Dado per colonna / <i>Wheel nut</i>	M22x1,5	1013-1213-1413-1613-2026-2626	3854000124 6174000024
8	729046	Rondella spaccata per colonna / <i>Lockwasher</i>		1013-1213-1413-1613-2026-2626	74361022351
9	729374	Colonna fissaggio ruote / <i>Wheel stud</i>	M22x1,5 L=68	ATEGO - ACTROS	9424010271
10	729369	Colonna fissaggio ruote / <i>Wheel stud</i>	M22x1,5 L=80	ATEGO - ACTROS	-
11	729364	Colonna fissaggio ruote / <i>Wheel stud</i>	M22x1,5 L=90	ATEGO - ACTROS	9424010371
12	729375	Colonna fissaggio ruote / <i>Wheel stud</i>	M22x1,5 L=110	ATEGO - ACTROS	3814010771
13	729659	Dado per colonna / <i>Wheel nut</i>	M22x1,5 H=27	ATEGO - ACTROS	0004010672
14	729786	Dado di fissaggio mozzo / <i>Axle nut</i>	M55x1,5		3463530072 3853510572
15	713795	Mozzo ruota nudo / <i>Wheel hub, bare</i>		ATEGO	9753300425
16	728716	Kit cuscinetto completo / <i>Bearing assembly</i>	ø 78x130x90	ATEGO - ATEGO 2	0139819805 0139812205 0139812305
17	713638	Mozzo ruota nudo / <i>Wheel hub, bare</i>		ACTROS	9423340701 9423341201
18	728703	Kit cuscinetto completo (2 parti + paraolio) <i>Bearing assembly (two parts c/w oil seal)</i>		ACTROS ACTROS MP2 AXOR	0119816805 0119816905 0139814205 0139814305
19	713950	Mozzo ruota nudo / <i>Wheel hub, bare</i>		ATEGO	9723340201
20	728736	Kit cuscinetto completo / <i>Bearing assembly</i>	ø 60x108x75	ATEGO - ATEGO 2	9723300225 0149815705 0159811905 9723300525 201050
21	713952	Mozzo ruota nudo / <i>Wheel hub, bare</i>		ACTROS - ACTROS MP2 ACTROS MP4 AXOR - AXOR 2	9433340701 9433301125S 9433301225S
22	728648	Cuscinetto a cartuccia / <i>Cassette bearing</i>			0149819305
23	728730	Cuscinetto esterno mozzo / <i>Hub bearing, outer</i>	ø 50x90x32	ATEGO 2 Serie MK - SK - NG Series	0029817905 0039818305 0049814205 0059814005 33210 VKHB2068
24	730858	Guarnizione per calotta / <i>Gasket</i>		ATEGO ACTROS	9433340080 3273560181
25	727261	Ruota fonica / <i>Impulse wheel</i>	80 denti / <i>teeth</i>	ACTROS	9763560015
26	727294	Ruota fonica / <i>Impulse wheel</i>	ø 160x164/188x12	ACTROS ACTROS MP2 - ACTROS MP3 ATEGO - ATEGO 2 - AXOR - AXOR 2	9423340015 9423340115
27	727295	Ruota fonica / <i>Impulse wheel</i>	ø 140x178x15 100 denti / <i>teeth</i>	ACTROS - ACTROS MP2 ACTROS MP4 - ACTROS - AROCS ATEGO - AXOR - AXOR 2	9433340115

1

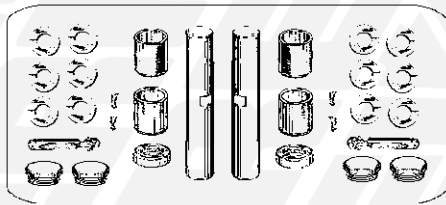

711108
1
NEW

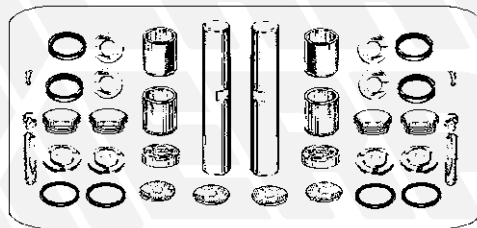

711109
2
NEW

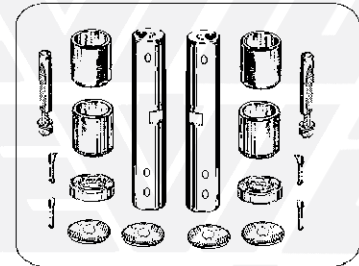

711107
3
NEW

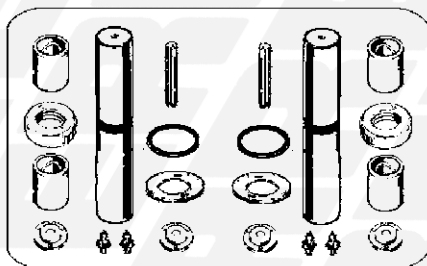

711105
4
NEW

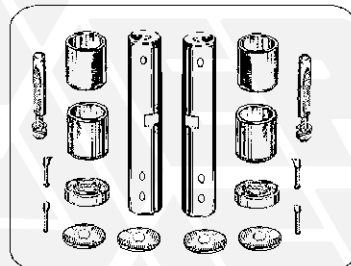

711106
5
NEW

2



729814
7
NEW



729394
6

FIG. ITEM	RIF. ERREVI ERREVI REF.	DESCRIZIONE PARTICOLARI DESCRIPTION		TIPO VEHICLE MODEL	RIF. ORIG. ORIG. REF.
NISSAN					
1 FUSI A SNODO / STEERING KNUCKLES					
1	711108	Complessivo revisione perni fusi c/cuscinetto (2 RUOTE) <i>King pin repair kit (Services 2 WHEELS)</i>	Perno / Pin ø 25 L=136 mm	TRADE	019053751A
2	711109	Complessivo revisione perni fusi c/cuscinetto (2 RUOTE) <i>King pin repair kit (Services 2 WHEELS)</i>	Perno / Pin ø 25 L=145 mm	CABSTAR 90 - 110 ECOT100	40022G4800
3	711107	Complessivo revisione perni fusi c/cuscinetto (2 RUOTE) <i>King pin repair kit (Services 2 WHEELS)</i>	Perno / Pin ø 26,67 L=171 mm	ATLEON 110 - 120 ECOT100	119022640A
4	711105	Complessivo revisione perni fusi c/cuscinetto (2 RUOTE) <i>King pin repair kit (Services 2 WHEELS)</i>	Perno / Pin ø 28,7 L=178 mm	ATLEON 120	400229X62A
5	711106	Complessivo revisione perni fusi c/cuscinetto (2 RUOTE) <i>King pin repair kit (Services 2 WHEELS)</i>	Perno / Pin ø 35 L=176 mm	ATLEON 140 - 160 ECOT135 - T165	119022651A
2 MOZI E RUOTE / HUBS AND WHEELS					
6	729394	Colonna fissaggio ruote / <i>Wheel stud</i>	M16x1,5 L=59	CABSTAR 110-120	402229X50B 43222F3600
7	729814	Dado per colonna / <i>Wheel nut</i>	M16x1,5		402249X50A 402249X500

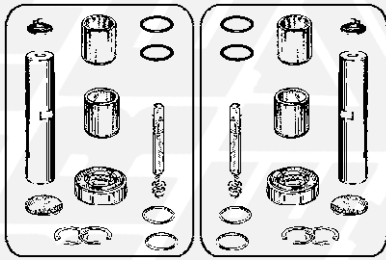

1 - S11821
NEW 2 - 711821
1 - S11821
NEW

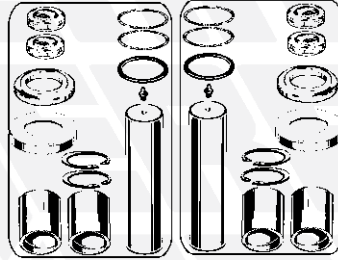

3 - S11898
NEW 4 - 711898
3 - S11898
NEW

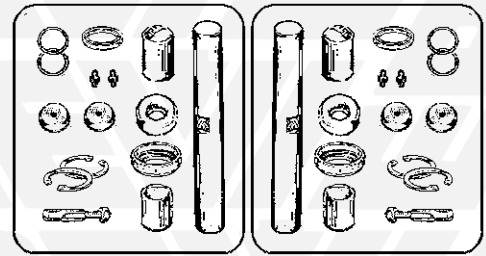

5 - S11740
NEW 6 - 711740
5 - S11740
NEW

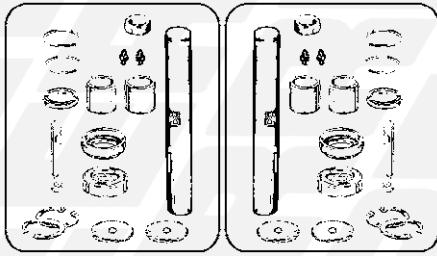

7 - S11826
NEW 8 - 711826
7 - S11826
NEW

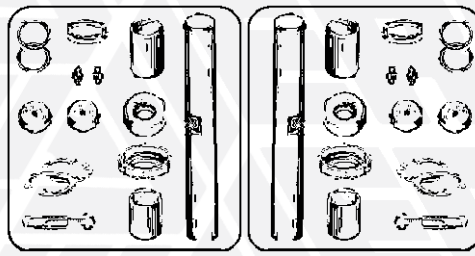

9 - S11777
NEW 10 - 711777
9 - S11777
NEW

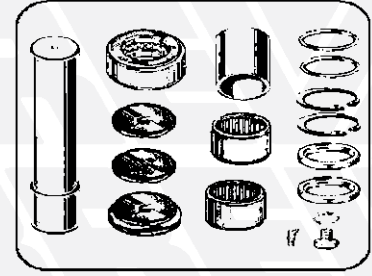

11 - S11975
NEW

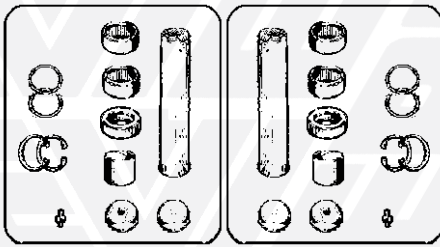

12 - S11782
NEW 13 - 711782
12 - S11782
NEW

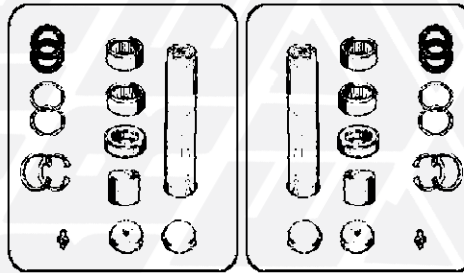

14 - S11786
NEW 15 - 711786
14 - S11786
NEW

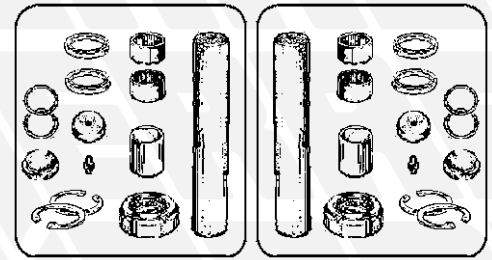

16 - S11741
NEW 17 - 711741
16 - S11741
NEW

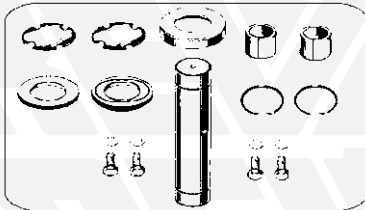

18 - S11976
NEW

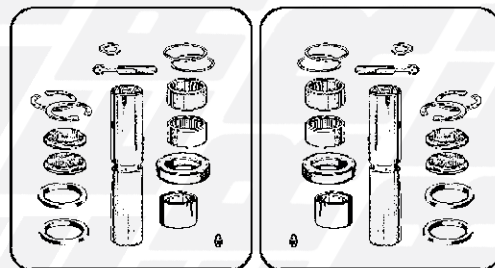

19 - S11825
NEW 20 - 711825
19 - S11825
NEW

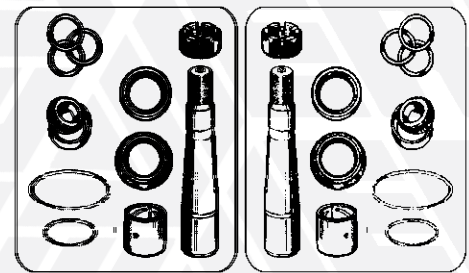

21 - S11779
NEW 22 - 711779
21 - S11779
NEW

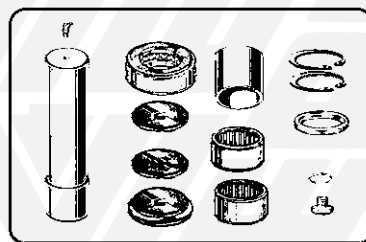

23 - S11118
NEW

FIG. ITEM	RIF. ERREVI ERREVI REF.	DESCRIZIONE PARTICOLARI DESCRIPTION	TIPO VEHICLE MODEL	RIF. ORIG. ORIG. REF.
RENAULT				
FUSI A SNODO / STEERING KNUCKLES				
1	S11821	Complessivo revisione perni fusi (1 RUOTA) King pin repair kit (Services 1 WHEEL)	Perno / Pin ø 40 L=241	MANAGER 5000793828
2	711821	Complessivo revisione perni fusi (2 RUOTE) King pin repair kit (Services 2 WHEELS)		
3	S11898	Complessivo revisione perni fusi (1 RUOTA) King pin repair kit (Services 1 WHEEL)	Perno / Pin ø 27,5/28 L=155	MASCOTT 5001865610
4	711898	Complessivo revisione perni fusi (2 RUOTE) King pin repair kit (Services 2 WHEELS)		
5	S11740	Complessivo revisione perni fusi (1 RUOTA) King pin repair kit (Services 1 WHEEL)	Perno / Pin ø 28 L=153	MIDLINER 5000793641
6	711740	Complessivo revisione perni fusi (2 RUOTE) King pin repair kit (Services 2 WHEELS)		
7	S11826	Complessivo revisione perni fusi (1 RUOTA) King pin repair kit (Services 1 WHEEL)	Perno / Pin ø 30 L=167	MIDLINER 5000336306
8	711826	Complessivo revisione perni fusi (2 RUOTE) King pin repair kit (Services 2 WHEELS)		
9	S11777	Complessivo revisione perni fusi (1 RUOTA) King pin repair kit (Services 1 WHEEL)	Perno / Pin ø 35 L=178	MIDLINER 5000794185 5000336305
10	711777	Complessivo revisione perni fusi (2 RUOTE) King pin repair kit (Services 2 WHEELS)		
11	S11975	Complessivo revisione perni fusi (1 RUOTA) King pin repair kit (Services 1 WHEEL)	Perno / Pin ø 45 L=214	MIDLUM 7420865912 7421944973 7421356465 7482077724
12	S11782	Complessivo revisione perni fusi (1 RUOTA) King pin repair kit (Services 1 WHEEL)	Perno / Pin ø 35 L=179	MIDLUM 5010630991 7420865911
13	711782	Complessivo revisione perni fusi (2 RUOTE) King pin repair kit (Services 2 WHEELS)		
14	S11786	Complessivo revisione perni fusi (1 RUOTA) King pin repair kit (Services 1 WHEEL)	Perno / Pin ø 45 L=214	MIDLUM 5010630992
15	711786	Complessivo revisione perni fusi (2 RUOTE) King pin repair kit (Services 2 WHEELS)		
16	S11741	Complessivo revisione perni fusi (1 RUOTA) King pin repair kit (Services 1 WHEEL)	Perno / Pin ø 50 L=236	MIDLUM - PREMIUM - MAGNUM 5010216742 5010630993 7420865913
17	711741	Complessivo revisione perni fusi (2 RUOTE) King pin repair kit (Services 2 WHEELS)		
18	S11976	Complessivo revisione perni fusi (1 RUOTA) King pin repair kit (Services 1 WHEEL)	Perno / Pin ø 70 L=295	PREMIUM - MAGNUM AE MAGNUM E-TECH 5001852793
19	S11825	Complessivo revisione perni fusi (1 RUOTA) King pin repair kit (Services 1 WHEEL)	Perno / Pin ø 50 L=225	Serie G - R Series KERAX - MAGNUM - PREMIUM PREMIUM2 5010630994 5010056002 7485135013
20	711825	Complessivo revisione perni fusi (2 RUOTE) King pin repair kit (Services 2 WHEELS)		
21	S11779	Complessivo revisione perni fusi con cuscinetto (1 RUOTA) King pin repair kit c/w bearing (Services 1 WHEEL)	Perno / Pin ø 40/60 L=227	PREMIUM 2 - MAGNUM - KERAX 7420590486 7485133870
22	711779	Complessivo revisione perni fusi con cuscinetti (2 RUOTE) King pin repair kit c/w bearings (Services 2 WHEELS)		
23	S11118	Complessivo revisione perni fusi (1 RUOTA) King pin repair kit (Services 1 WHEEL)	Perno / Pin ø 50 L=236	MAGNUM AE - MIDLUM PREMIUM 7422536158 7421351974 7482077738



719113
1



729624
7



729174
4



729393
5



729386
6



719116
2
NEW



719119
3
NEW



728722
8



728730
9



729774
10



729779
14



728705
15



728602
13

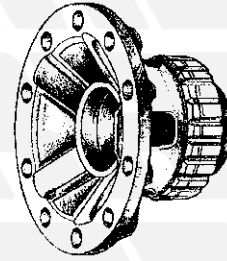

11 - 713775
Compl. / Assembly

12 - 713918
Compl. FAG
FAG Assembly

NEW



730770
17



727289
18



727293
19

NEW

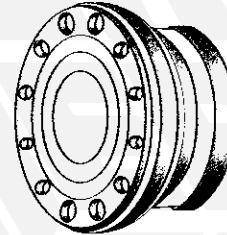

713779
16

FIG. ITEM	RIF. ERREVI ERREVI REF.	DESCRIZIONE PARTICOLARI DESCRIPTION		TIPO VEHICLE MODEL	RIF. ORIG. ORIG. REF.
MOZZI E RUOTE / HUBS AND WHEELS					
1	719113	Calotta coprimozzo / Hub cap		MIDLUM - PREMIUM MAGNUM - KERAX	5010571187
2	719116	Calotta coprimozzo completa di o.ring / Hub cap assembly	ø 116	MIDLUM	5010571188
3	719119	Calotta coprimozzo completa di o.ring / Hub cap c/w o.ring	M128x2	KERAX - MUGNUM AE MAGNUM Dxi MAGNUM E.TECH PREMIUM - PREMIUM 2	7403988672 7421302471
4	729174	Colonna fissaggio ruota / Wheel stud	M22x1,5 L=78	Serie G - R Series	5010319141 0000190221
5	729393	Colonna fissaggio ruota / Wheel stud	M22x1,5 L=79	MAGNUM - PREMIUM	7420515514
6	729386	Colonna fissaggio ruota / Wheel stud	M22x1,5 L=88	PREMIUM - KERAX	7420515515
7	729624	Dado per colonna / Wheel nut	M22x1,5	Serie G - R Series	5010262935 5010097347 5010457733 7420551045
8	728722	Cuscinetto interno mozzo / Hub bearing, inner	ø 90x140x32	MIDLUM - MIDLINER	5000254793 5010439301 32018XA VKHB2170
9	728730	Cuscinetto esterno mozzo / Hub bearing, outer	ø 50x90x32	MIDLINER - MAXTER - MAGNUM KERAX	5010439057 5000442185 5000442186 5000442189 5000470861 5000669957 33210 VKHB2068
10	729774	Ghiera fissaggio mozzo / Axle locking nut	M60x2	MAGNUM - PREMIUM - KERAX	7420424598
11	713775	Mozzo ruota completo / Wheel hub assembly			7485114470
12	713918	Mozzo ruota completo di cuscinetto FAG Wheel hub assembly (complete with FAG bearing)		PREMIUM - MAGNUM DXI	7485114470
13	728602	Cuscinetto a cartuccia / Cassette bearing	ø 68x125x115		7420967831 7421021391
14	729779	Ghiera fissaggio mozzo / Axle locking nut	M52x2 L=21,5		7420456099
15	728705	Kit cuscinetto completo / Bearing assembly	ø 58x110x115	PREMIUM - PREMIUM 2 MAGNUM DXI	7420518617 7421021381 7420967830
16	713779	Mozzo ruota completo di cuscinetto e ruota fonica/ Wheel hub assembly		MIDLUM - PREMIUM MAGNUM - KERAX	5010439770
17	730770	Paraolio mozzo / Oil seal	ø 120x160x15	MIDLUM - MIDLINER - PREMIUM MAGNUM - KERAX	0024472667 5000671980 5000788490
18	727289	Ruota fonica / Impulse wheel	ø 132x146x12 100 denti/teeths	PREMIUM - MAGNUM	7420392016
19	727293	Ruota fonica / Impulse wheel	ø 154x158x16 100 denti/teeths	Serie C - D - K - T Series	7401075889

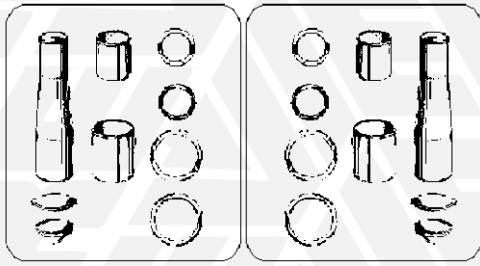

1 - S11301
NEW

1 - S11301
NEW

2 - 711301

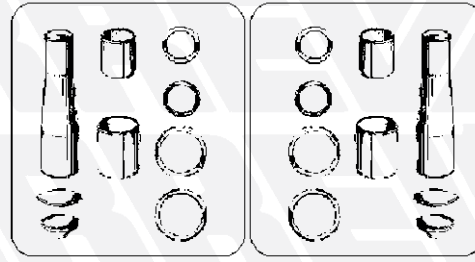

3 - S11747
NEW

3 - S11747
NEW

4 - 711747

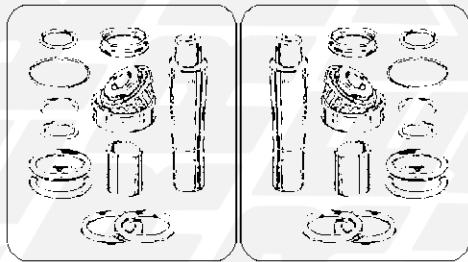

5 - S11973
NEW

5 - S11973
NEW

6 - 711973

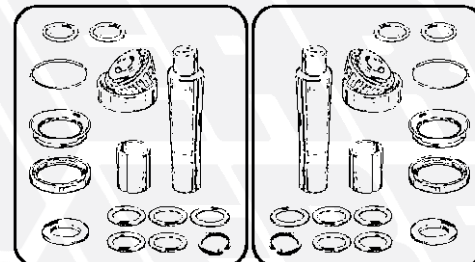

7 - S11720
NEW

7 - S11720
NEW

8 - 711720

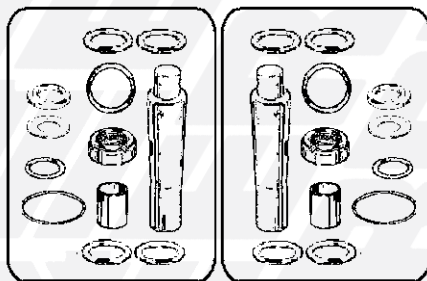

9 - S11746
NEW

9 - S11746
NEW

10 - 711746

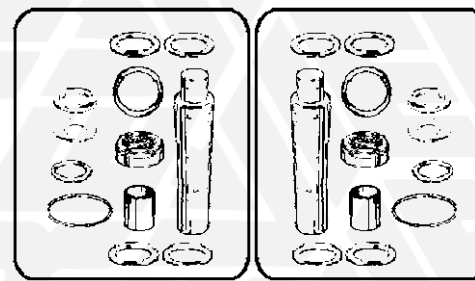

11 - S11745
NEW

11 - S11745
NEW

12 - 711745

FIG. ITEM	RIF. ERREVI ERREVI REF.	DESCRIZIONE PARTICOLARI DESCRIPTION	TIPO VEHICLE MODEL	RIF. ORIG. ORIG. REF.	
SCANIA					
FUSI A SNODO / STEERING KNUCKLES					
1	S11301	Completivo revisione perni fusi (1 RUOTA) <i>King pin repair kit (Services 1 WHEEL)</i>	Perno / Pin ø 44,5/53,5 L=228	110 - 111 - 140 - 141 - 142 92 - 112 - 146	550713 550714 550732
2	711301	Completivo revisione perni fusi (2 RUOTE) <i>King pin repair kit (Services 2 WHEELS)</i>			
3	S11747	Completivo revisione perni fusi (1 RUOTA) <i>King pin repair kit (Services 1 WHEEL)</i>	Perno / Pin ø 36/44 L=215	92 - 112 - 142	550733 550723 550711
4	711747	Completivo revisione perni fusi (2 RUOTE) <i>King pin repair kit (Services 2 WHEELS)</i>			
5	S11973	Completivo revisione perni fusi con cuscinetto (1 RUOTA) <i>King pin repair kit c/w bearing (Services 1 WHEEL)</i>	Perno / Pin ø 44,5x54 L=215	93 - 113 - 143	550729 550730
6	711973	Completivo revisione perni fusi con cuscinetti (2 RUOTE) <i>King pin repair kit c/w bearings (Services 2 WHEELS)</i>			
7	S11720	Completivo revisione perni fusi con cuscinetto (1 RUOTA) <i>King pin repair kit c/w bearing (Services 1 WHEEL)</i>	Perno / Pin ø 45/55 L=224	94 - 114 - 124 - 144 - 164	550257 550284
8	711720	Completivo revisione perni fusi con cuscinetti (2 RUOTE) <i>King pin repair kit c/w bearings (Services 2 WHEELS)</i>			
9	S11746	Completivo revisione perni fusi con cuscinetto (1 RUOTA) <i>King pin repair kit c/w bearing (Services 1 WHEEL)</i>	Perno / Pin ø 45/57 L=243	93 - 113 - 143	550722
10	711746	Completivo revisione perni fusi con cuscinetti (2 RUOTE) <i>King pin repair kit c/w bearings (Services 2 WHEELS)</i>			
11	S11745	Completivo revisione perni fusi con cuscinetto (1 RUOTA) <i>King pin repair kit c/w bearing (Services 1 WHEEL)</i>	Perno / Pin ø 45/57 L=243	93 - 113 - 143	550731
12	711745	Completivo revisione perni fusi con cuscinetti (2 RUOTE) <i>King pin repair kit c/w bearings (Services 2 WHEELS)</i>			



729268
8



729161
3



4 - 729380
5 - 729381



729396
6



729397
7



719117
2

NEW

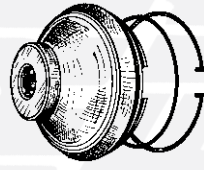

719106
1

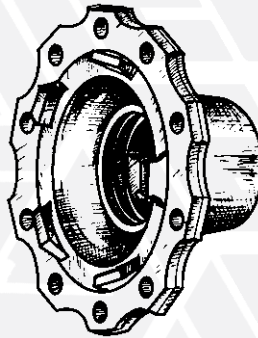

9 - 713750 Nudo / Bare

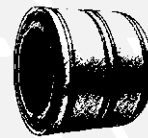

728601
10



719117
2

NEW

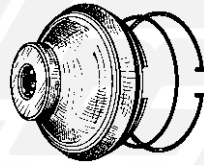

719106
1

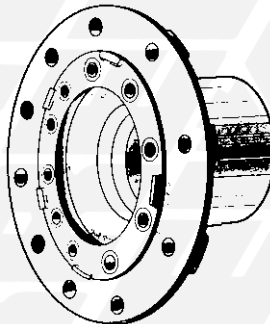

11 - 713752 Nudo / Bare

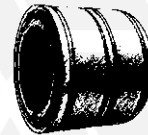

728601
12



13 - 728727
14 - 728725



15 - 728726
16 - 728734



729787
17



730772
18



726377
19



727268
20



727288
21

FIG. ITEM	RIF. ERREVI ERREVI REF.	DESCRIZIONE PARTICOLARI DESCRIPTION		TIPO VEHICLE MODEL	RIF. ORIG. ORIG. REF.
MOZZI E RUOTE / HUBS AND WHEELS					
1	719106	Calotta coprimozzo (completa di tappo) / <i>Hub cap</i>		94 - 114 - 124 - 144 - 164	1762224
2	719117	Calotta coprimozzo completa di o.ring / <i>Hub cap assembly</i>		94 - 114 - 124 - 144 - 164 Serie P - G - R - T Series	1381114 1480333 1728076 1750065
3	729161	Colonna fissaggio ruota / <i>Wheel stud</i>	7/8" Dx L=70	81 - 86 - 111 - 141 - 142	290062 397266 1368690
4	729380	Colonna fissaggio ruota / <i>Wheel stud</i>	7/8" 11BSF L=75		1368691 332912
5	729381	Colonna fissaggio ruota / <i>Wheel stud</i>	7/8" 11BSF L=102	94 - 114 - 124	1368695 337560
6	729396	Colonna fissaggio ruota / <i>Wheel stud</i>	7/8" - 11BSF L=72	Serie P - G - R - T Series	1868665
7	729397	Colonna fissaggio ruota / <i>Wheel stud</i>	7/8" - 11BSF L=85	Serie P - G - R - T Series 94 - 114 - 124	2285279 1528712
8	729268	Dado / <i>Wheel nut</i>	7/8" Dx H=26		318690 1365510 1749034 243956
9	713750	Mozzo ruota nudo / <i>Wheel hub, bare</i>		94-114-124-144-164 (per freno a tamburo / <i>brake drum</i>)	1414154 1382774
10	728601	Cuscinetto a cartuccia / <i>Cassette bearing</i>	ø68x127x115		1382900 1413785 1439070 1476945 1724482
11	713752	Mozzo ruota nudo / <i>Wheel hub, bare</i>		94-114-124-144-164 (per freno a disco / <i>for brake disc system</i>)	1480933 1724406
12	728601	Cuscinetto a cartuccia / <i>Cassette bearing</i>	ø68x127x115		1382900 1413785 1439070 1476945 1724482
13	728727	Cuscinetto interno mozzo / <i>Hub bearing, inner</i>	ø105x160x43	82 - 92 - 112 - 142 - 93 - 113 - 143	351713 33021 VKHB2162
14	728725	Cuscinetto esterno mozzo / <i>Hub bearing, outer</i>	ø110x170x38	82 - 92 - 112 - 142 - 93 - 113 - 143	351715 264960 362226 32022X VKHB2281
15	728726	Cuscinetto esterno mozzo / <i>Hub bearing, outer</i>	ø45x100x38,25	82 - 92 - 112 - 142 - 93 - 113 - 143	397314 1362149 014623 32309A VKHB2004
16	728734	Cuscinetto interno mozzo / <i>Hub bearing, inner</i>	ø70x130x43	Serie 3 Series	322748 VKHB2024 T2ED070
17	729787	Ghiera fissaggio mozzo / <i>Grooved nut</i>	M60x2	94 - 114 - 124 - 144	1356196 1403618 1873183
18	730772	Paraolio mozzo / <i>Oil seal, front</i>	ø75x100x10	94 - 114 - 124 - 144	1313719 1409890
19	726377	Rondella fissaggio mozzo / <i>Retaining washer</i> Ch.105-Sp.8 / Key 105-Th.8	ø 68	Serie P - G - R - T Series Serie 3 - 4 Series	1365594
20	727268	Ruota fonica / <i>Impulse wheel</i>	ø 126x164x8,5 100 denti/teeth	Serie 3 - 4 Series	1339680 1375382
21	727288	Ruota fonica / <i>Impulse wheel</i>	ø 126x170x8,5	94-114-124-144-164 Serie P-G-R-T Series	1442300

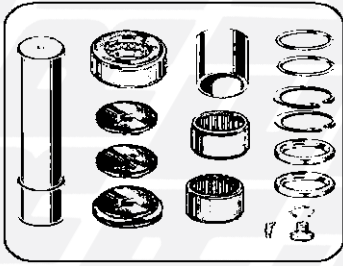

1 - S11975
NEW

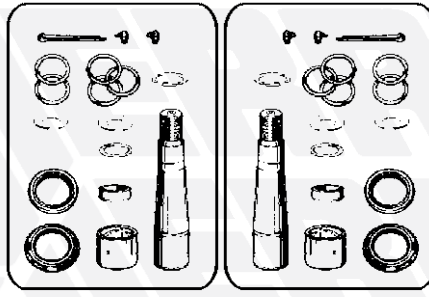

2 - S11725 **NEW** 2 - S11725 **NEW**
3 - 711725

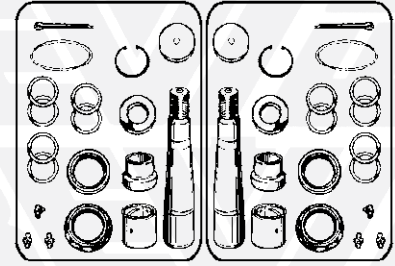

4 - S11726 **NEW** 4 - S11726 **NEW**
5 - 711726

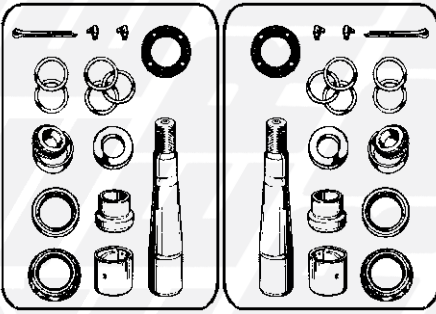

6 - S11379 **NEW** 6 - S11379 **NEW**
7 - 711379

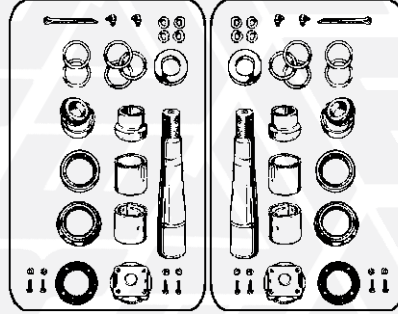

8 - S11302 **NEW** 8 - S11302 **NEW**
9 - 711302

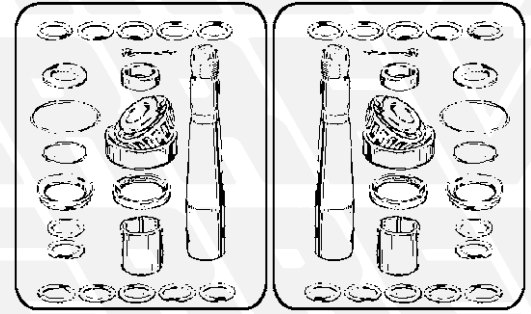

10 - S11933 **NEW** 10 - S11933 **NEW**
11 - 711933

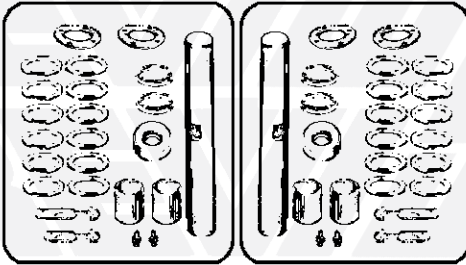

12 - S11780 **NEW** 12 - S11780 **NEW**
13 - 711780

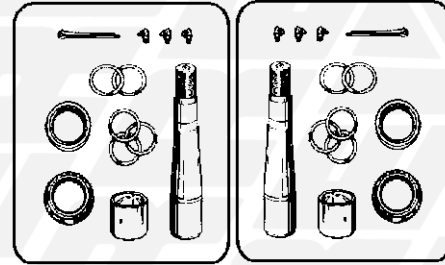

14 - S11738 **NEW** 14 - S11738 **NEW**
15 - 711738

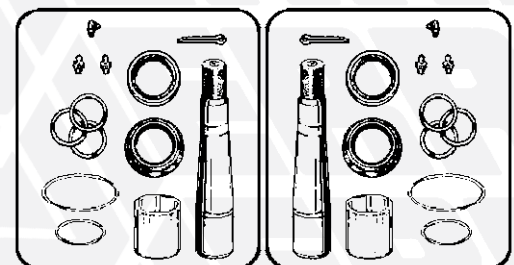

16 - S11728 **NEW** 16 - S11728 **NEW**
17 - 711728

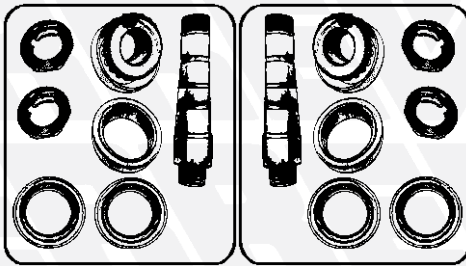

18 - S11778 **NEW** 18 - S11778 **NEW**
19 - 711778

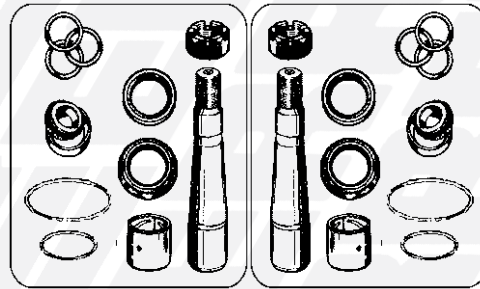

20 - S11779 **NEW** 20 - S11779 **NEW**
21 - 711779

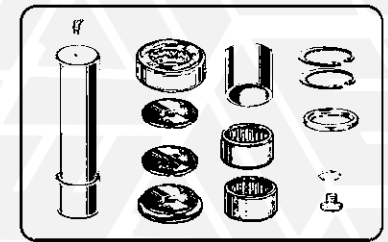

22 - S11118 **NEW**

FIG. ITEM	RIF. ERREVI ERREVI REF.	DESCRIZIONE PARTICOLARI DESCRIPTION	TIPO VEHICLE MODEL	RIF. ORIG. ORIG. REF.
VOLVO				
FUSI A SNODO / STEERING KNUCKLES				
1	S11975	Complessivo revisione perni fusi (1 RUOTA) <i>King pin repair kit (Services 1 WHEEL)</i>	Perno / Pin ø 45 L=214	FL 20865912 21356465 82077724
2	S11725	Complessivo revisione perni fusi (1 RUOTA) <i>King pin repair kit (Services 1 WHEEL)</i>	Perno / Pin ø 34/45 L=193	FL6 - FL6.08 - FL6.11 270920
3	711725	Complessivo revisione perni fusi (2 RUOTE) <i>King pin repair kit (Services 2 WHEELS)</i>		
4	S11726	Complessivo revisione perni fusi (1 RUOTA) <i>King pin repair kit (Services 1 WHEEL)</i>	Perno / Pin ø 35/45,1 L=220	FL6 - FL6.12 - FL6.15 276193 276033
5	711726	Complessivo revisione perni fusi (2 RUOTE) <i>King pin repair kit (Services 2 WHEELS)</i>		
6	S11379	Complessivo revisione perni fusi (1 RUOTA) con cuscinetto <i>King pin repair kit (Services 1 WHEEL) c/w bearing</i>	Perno / Pin ø 34/45 L=237	F86 - F88 - F89 - N86 - N88 N7 - N10 - N12 276014 276029
7	711379	Complessivo revisione perni fusi (2 RUOTE) con cuscinetti <i>King pin repair kit (Services 2 WHEELS) c/w bearings</i>		
8	S11302	Complessivo revisione perni fusi (1 RUOTA) con cuscinetto <i>King pin repair kit (Services 1 WHEEL) c/w bearing</i>	Perno / Pin ø 37/48 L=237	F7 - F10 - F12 - F16 N7 - N10 - N12 FL7 - FL10 - FL12 271141 270911 276015 276030 276032 3090267
9	711302	Complessivo revisione perni fusi (2 RUOTE) con cuscinetti <i>King pin repair kit (Services 2 WHEELS) c/w bearings</i>		
10	S11933	Complessivo revisione perni fusi (1 RUOTA) con cuscinetto <i>King pin repair kit (Services 1 WHEEL) c/w bearing</i>	Perno / Pin ø 38/50 L=250	FL7 - FL10 - FL12 F10 - F12 - F16 FH12 - FH16 N7 - NL10 - NL12 270912 271142 276023 276031 3090266
11	711933	Complessivo revisione perni fusi (2 RUOTE) con cuscinetti <i>King pin repair kit (Services 2 WHEELS) c/w bearings</i>		
12	S11780	Complessivo revisione perni fusi (1 RUOTA) <i>King pin repair kit (Services 1 WHEEL)</i>	Perno / Pin ø 50 L=269	FL10 - FM7 - FM10 - FM12 NL10 - NL12 - FL12 1699357
13	711780	Complessivo revisione perni fusi (2 RUOTE) <i>King pin repair kit (Services 2 WHEELS)</i>		
14	S11738	Complessivo revisione perni fusi (1 RUOTA) <i>King pin repair kit (Services 1 WHEEL)</i>	Perno / Pin ø 40/51 L=223	FH12 - FH16 - FM7 FM9 - FM10 - FM12 - B12 3092467
15	711738	Complessivo revisione perni fusi (2 RUOTE) <i>King pin repair kit (Services 2 WHEELS)</i>		
16	S11728	Complessivo revisione perni fusi (1 RUOTA) <i>King pin repair kit (Services 1 WHEEL)</i>	Perno / Pin ø 40/60 L=231	FH12 - FH16 - FM7 FM9 - FM10 - FM12 - B12 3093731
17	711728	Complessivo revisione perni fusi (2 RUOTE) <i>King pin repair kit (Services 2 WHEELS)</i>		
18	S11778	Complessivo revisione perni fusi (1 RUOTA) con cuscinetto <i>King pin repair kit (Services 1 WHEEL) c/w bearing</i>	Perno / Pin ø 40/53 L=232	FL6 - FM7 - FM9 - FM10 - FM12 B12 - FH12 - FH16 20751021
19	711778	Complessivo revisione perni fusi (2 RUOTE) con cuscinetti <i>King pin repair kit (Services 2 WHEELS) c/w bearings</i>		
20	S11779	Complessivo revisione perni fusi (1 RUOTA) con cuscinetto <i>King pin repair kit (Services 1 WHEEL) c/w bearing</i>	Perno / Pin ø 40/60 L=227	FM7 - FM9 - FM10 - FM12 FH12 - FH16 85108338 20590486
21	711779	Complessivo revisione perni fusi (2 RUOTE) con cuscinetti <i>King pin repair kit (Services 2 WHEELS) c/w bearings</i>		
22	S11118	Complessivo revisione perni fusi (1 RUOTA) <i>King pin repair kit (Services 1 WHEEL)</i>	Perno / Pin ø 50 L=236	FE - FL2 22536158 20865913 82077738

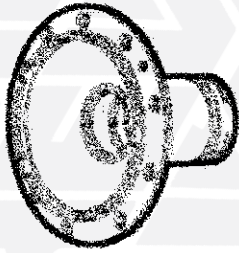

713648
1

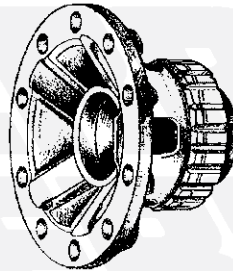

2 - 713775 Compl. / Assembly

NEW 3 - 713918
Compl. FAG / FAG Assembly

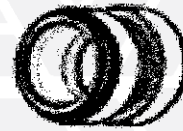

728602
8

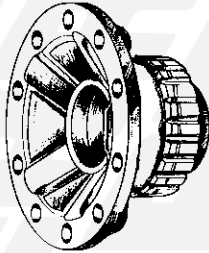

4 - 713903 Compl. / Assembly

NEW 5 - 713920
Compl. FAG / FAG Assembly

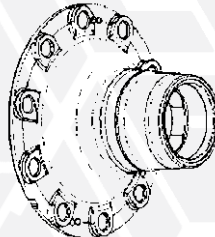

NEW 6 - 713945

NEW 7 - 713946 Compl. / Assembly



728602
8

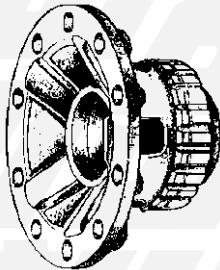

713793
9

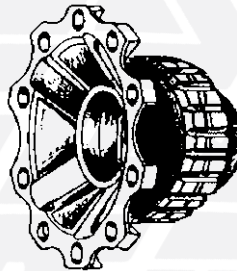

10 - 713904 Compl. / Assembly

NEW 11 - 713921 Compl. FAG / FAG Assembly



728705
12



719093
13



719119
14

NEW



729258
16



729155
15



732741
21



729624
20



17 - 729393
18 - 729386
19 - 729395

FIG. ITEM	RIF. ERREVI ERREVI REF.	DESCRIZIONE PARTICOLARI DESCRIPTION	TIPO VEHICLE MODEL	RIF. ORIG. ORIG. REF.
MOZZI E RUOTE / HUBS AND WHEELS				
1	713648	Mozzo ruota, nudo / <i>Wheel hub, bare</i>	FL6 - FL7 - FM10 - FM12 FH12 - FH16 (per freno a tamburo/for brake drum)	21024160 21024166 20534904
2	713775	Mozzo ruota completo / <i>Wheel hub assembly</i>	FH - FM (per freno a disco) / (for brake disc)	85111791 85114470
3	713918	Mozzo ruota completo di cuscinetto FAG <i>Wheel hub assembly (complete with FAG bearing)</i>	FH - FM	85111791 85114470
4	713903	Mozzo ruota completo / <i>Wheel hub assembly</i>	FM9 - FM12 - FM7 - FM10 FH12 - FH16 - FL6	85105693 85111794 85114471 85101818
5	713920	Mozzo ruota completo di cuscinetto FAG <i>Wheel hub assembly (complete with FAG bearing)</i>	FM9 - FM12 - FM7 - FM10 FH12 - FH16 - FL6	85105693 85111794 85114471 85101818
6	713945	Mozzo ruota nudo / <i>Wheel hub, bare</i>	FL6 - FM10 - FM12 - FM7 - FM9 FH12 - FH16 - NH12	20518092S 20518093S 21024155S
7	713946	Mozzo ruota completo / <i>Wheel hub assembly</i>	FL6 - FM10 - FM12 - FM7 - FM9 FH12 - FH16 - NH12	20518092 20518093 21024155
8	728602	Cuscinetto a cartuccia / <i>Cassette bearing</i>	ø 68x125x115 FL6 - FL7 - FM10 - FM12 FH12 - FH16	20967831 21021391
9	713793	Mozzo ruota completo / <i>Wheel hub, assembly</i>	FH - FM (per freno a disco) / (for brake disc)	85107749 85111789
10	713904	Mozzo ruota completo / <i>Wheel hub assembly</i>	FM9 - FM12 - FH12 - FH16	85111792 85105692 3099341
11	713921	Mozzo ruota completo di cuscinetto FAG <i>Wheel hub assembly (complete with FAG bearing)</i>	FM9 - FM12 FH12 - FH16	85111792 85105692 3099341
12	728705	Kit cuscinetto completo / <i>Bearing assembly</i>	ø 58x110x115 FH - FM	20967830 20528617 21021381
13	719093	Calotta coprimozzo completa di tappo <i>Hub cap</i>	M115x2	3985590 3963418
14	719119	Calotta coprimozzo completa di o.ring / <i>Hub cap c/w o.ring</i>	M128x2	3988672 21302471
15	729155	Colonna fissaggio ruota / <i>Wheel stud</i>	7/8" Dx L=83	F7 - F10 - F12 - F16 N7 - N10 - N12 1573081
16	729258	Dado per colonna / <i>Wheel nut</i>	7/8" Dx H=35	F7 - F10 - F12 - F16 N7 - N10 - N12 943491 1083894
17	729393	Colonna fissaggio ruota / <i>Wheel stud</i>	M22x1,5 L=79	FH - FH12 - FH16 FL6 - FM - FM12 20515514
18	729386	Colonna fissaggio ruota / <i>Wheel stud</i>	M22x1,5 L=88	FH12 - FH16 - FH FL6 - FM - FM12 20515515
19	729395	Colonna fissaggio ruota / <i>Wheel stud</i>	M22x1,5 L=105	B7 - B10 - B12 - FH - FM FH12 - FH16 - FM9 - FM12 20515519
20	729624	Dado per colonna / <i>Wheel nut</i>	M22x1.5 H=31 Ch / Key 33	FM9 - FM12 FH12 - FH16 20551045 21303956 21402076
21	732741	Coperchio per dado colonna / <i>Nut cover</i>	Ch / Key 32	3943983 1609675



728734
1

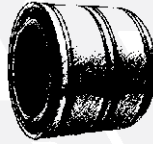

728736
2

NEW



729774
3



729775
4



729779
5

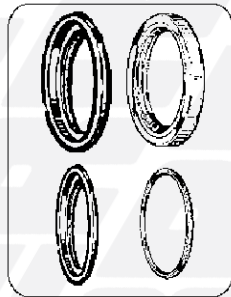

730779
6



730761
7



730777
8

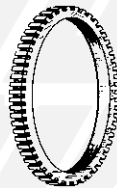

727289
9



727293
10

NEW



727291
11

FIG. ITEM	RIF. ERREVI ERREVI REF.	DESCRIZIONE PARTICOLARI DESCRIPTION		TIPO VEHICLE MODEL	RIF. ORIG. ORIG. REF.
MOZZI E RUOTE / HUBS AND WHEELS					
1	728734	Cuscinetto interno mozzo / <i>Hub bearing, inner</i>	ø 70x130x43	F10 - F12 - F16 - FH12 - FH16 FL6 - FL7 - FL10 - FL12 FM7 - FM9 - FM10 - FM12	1584340 8151816 VKHB2024 T2ED070
2	728736	Kit cuscinetto completo (201050) / <i>Bearing assembly</i>	ø 60x108x75	FL6	3099161
3	729774	Ghiera fissaggio mozzo / <i>Axle nut</i>	M60x2	FL6 - FM9 - FM12 - FH12 - FH16	20424598
4	729775	Ghiera fissaggio mozzo / <i>Axle nut</i>	M80x2	F10 - F12 - F16 - FL7 - FL10 - FL12 FM7 - FM9 - FM10 - FM12 FH12 - FH16	1522384
5	729779	Ghiera fissaggio mozzo / <i>Axle nut</i>	M52x2 L=21,5		20456099
6	730779	Kit paraolio per mozzo / <i>Oil seal kit</i>		FL6 - FL7 - FL10 - FL12 FM7 - FM10 - FM12 - FH12 - FH16	3095043 3095042 8159000
7	730761	Paraolio mozzo anteriore / <i>Oil seal</i>	ø 110x140x21	F7 - F10 - F12 - F16 - FL6 - FL7 FM10 - FM12 - FH12 - FH16	1089552 1587792
8	730777	Paraolio interno mozzo / <i>Oil seal, inner</i>	ø 120x140x13	F12	1696066
9	727289	Ruota fonica / <i>Impulse wheel</i>	ø 132x146x12 100 denti / <i>teeth</i>	FM9 - FM12 FH12 - FH16 - FM - FH	20392016
10	727293	Ruota fonica / <i>Impulse wheel</i>	ø 154x158x16 100 denti / <i>teeth</i>	FH12 - FH16 - FL6 FM7 - FM9 - FM10 - FM12 B9 - B12	1075889
11	727291	Ruota fonica / <i>Impulse wheel</i>	ø 164,2x168,2x16 100 denti / <i>teeth</i>	FH12 - FH16 FL6 - FM10 - FM12 - FM9	8156339