

FRIZIONE / CLUTCH

RICAMBI PER / SPARE PARTS FOR

DAF	pag.	48 - 49
IVECO	pag.	48 - 59
MAN	pag.	58 - 59
MERCEDES	pag.	60 - 61
RENAULT	pag.	60 - 61
SCANIA	pag.	60 - 61
VOLVO	pag.	60 - 61

1

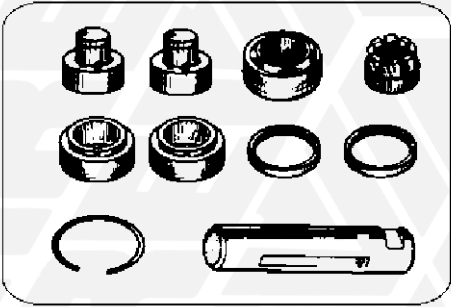

711218
1

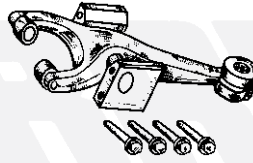

717076
2

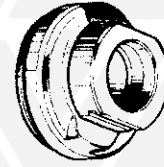

716594
3

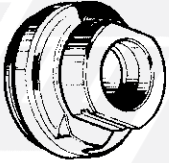

716569
4

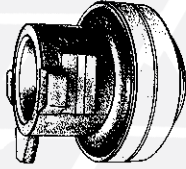

716602
5



716600
6

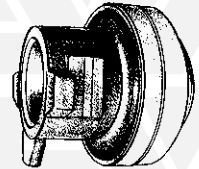

716597
7

2

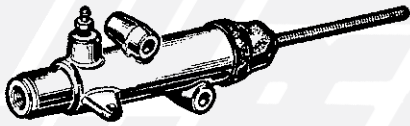

718038
8

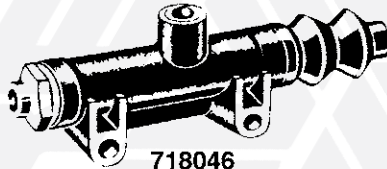

718046
9



717054
10



716587
11

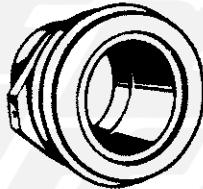

716588
12



732029
13



728529
14

3

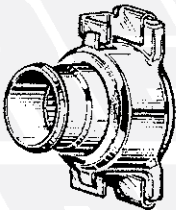

716570
15 - 19

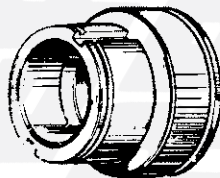

716568
16



728264
17

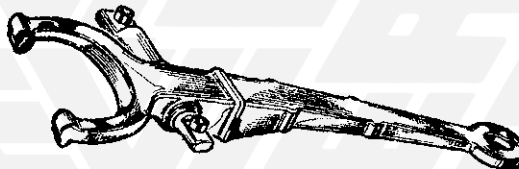

717072
18

FIG. ITEM	RIF. ERREVI ERREVI REF.	DESCRIZIONE PARTICOLARI DESCRIPTION	TIPO VEHICLE MODEL	RIF. ORIG. ORIG. REF.
1 DAF				
1	711218	Complessivo revisione frizione / <i>Clutch release fork, repair kit</i>	75CF - 85CF - 95XF CF75 - CF85 - XF95	13163045 1391637S 1392537S
2	717076	Leva disinnesto frizione / <i>Withdrawal lever</i>	75CF - 85CF - 95XF CF75 - CF85 - XF95	1392537 1391637 1316304
3	716594	Manicotto distacco frizione con reggispinta / <i>Withdrawal sleeve assy</i>	F1100 - F1300 - F1500 - F1700 65FA	1267988 514454 659320 279810
4	716569	Manicotto distacco frizione con reggispinta / <i>Withdrawal sleeve assy</i>	75CF - 85CF - 95XF	266060 1261652
5	716602	Manicotto distacco frizione con reggispinta / <i>Withdrawal sleeve assy</i>	75CF - 85CF - 95XF CF85 - XF95	1250710 1303975 1664346
6	716600	Manicotto distacco frizione con reggispinta / <i>Withdrawal sleeve assy</i>	85CF - 95XF	1334350 1287806 1230548
7	716597	Manicotto distacco frizione con reggispinta / <i>Withdrawal sleeve assy</i>	CF85 - XF105	1746150 1697725 1822487 1830316 1686642
2 IVECO 616N3/4 - 50NC - 55NC				
8	718038	Cilindretto comando disinnesto / <i>Slave cylinder</i>		4311345 4189132
9	718046	Cilindro maestro comando disinnesto / <i>Master cylinder</i>	50NC - 55NC	4797845 4217083
10	717054	Leva a forcella disinnesto / <i>Withdrawal lever</i>		4605179
11	716587	Manicotto portareggispinta nudo / <i>Withdrawal sleeve</i>		-
12	716588	Manicotto portareggispinta c/cuscinetto / <i>Withdrawal sleeve assy</i>		4605181
13	732029	Molla richiamo manicotto disinnesto / <i>Sleeve spring</i>		4607761
14	728529	Reggispinta distacco (SKF 630086 A) / <i>Thrust bearing</i>	∅ 50x81,7x22	4614120
3 NEW DAILY (30.8 - 35.8 - 40.8) TURBO DAILY (35.10 - 40.10 - 45.10 - 49.10)				
15	716570	Manicotto distacco frizione c/reggispinta / <i>Withdrawal sleeve assy</i>	35.10 - 40.10 - 45.10 - 49.10	2992027 1905290
16	716568	Manicotto distacco frizione con reggispinta / <i>Withdrawal sleeve assy</i>	30.8 - 35.8 - 40.8	93800287
17	728264	Pernetto per leva disinnesto / <i>Pin</i>	30.8 - 35.8 - 40.8	93807414 93806132
NEW DAILY ('96) (30.8 - 35.8) TURBO DAILY ('96) (30.10 - 35.10 - 35.12 - 49.10 - 49.12 - 59.12) DAILY 2000 - DAILY CNG				
18	717072	Leva a forcella disinnesto completa / <i>Withdrawal fork</i>		42116734
19	716570	Manicotto distacco frizione c/reggispinta / <i>Withdrawal sleeve assy</i>		2992027 1905290

1

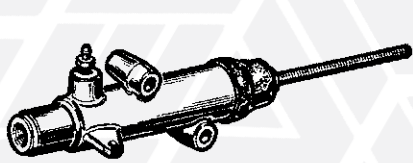

718038
1

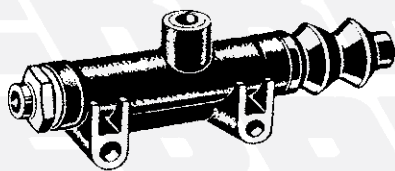

718046
2

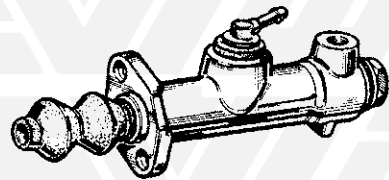

718213
3



717054
4



716587
5

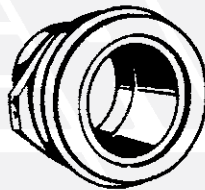

716588
6



732029
7



728529
8

2



718047
9

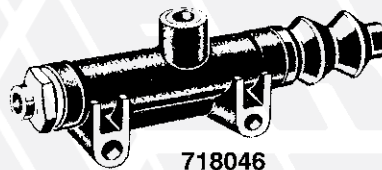

718046
10

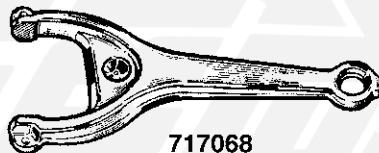

717068
11

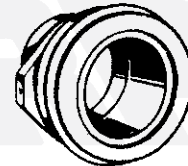

728543
12

3

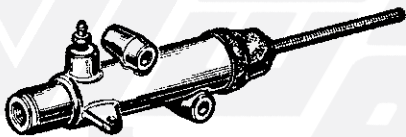

718038
13



718047
14

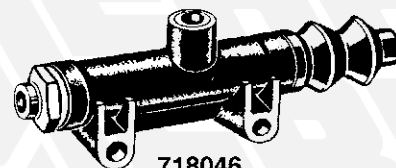

718046
15



716591
16

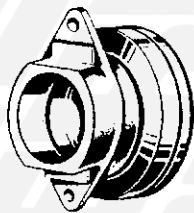

716592
17



732003
18

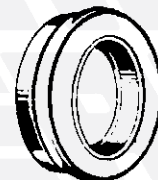

19 - 728527
20 - 728529

4

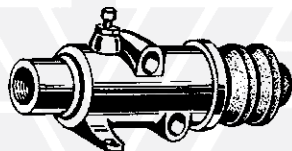

718043
21

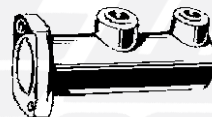

718007
22



716563
23



716565
24



732003
25



728522
26

FIG. ITEM	RIF. ERREVI ERREVI REF.	DESCRIZIONE PARTICOLARI DESCRIPTION	TIPO VEHICLE MODEL	RIF. ORIG. ORIG. REF.
1 35NC - 40NC - 45NC - 49NC 50.8/F8 - 55.8/F8 - 60.8/F8				
1	718038	Cilindretto comando disinnesto / <i>Slave cylinder</i>		4311345 4191164
2	718046	Cilindro maestro comando disinnesto / <i>Master cylinder</i>	50.8/F8 - 55.8/F8 - 60.8/F8	4797845 4217083
3	718213	Cilindro maestro comando disinnesto / <i>Master cylinder</i>	35NC - 40NC - 45NC - 49NC	4800161 4166208
4	717054	Leva a forcella disinnesto / <i>Withdrawal lever</i>		4605179
5	716587	Manicotto portareggispinta nudo / <i>Withdrawal sleeve</i>		-
6	716588	Manicotto portareggispinta con cuscinetto / <i>Withdrawal sleeve assy</i>		4605181
7	732029	Molla richiamo manicotto / <i>Sleeve spring</i>		4607761
8	728529	Reggispinta distacco (SKF 630086 A) / <i>Thrust bearing</i>	∅ 50x81,7x22	4614120
2 50.9Z - 60.11 TURBO Z - 65.9Z - 65.12 TURBO Z 79.12 TURBO Z - 79.14 U.T. - 95.14 U.T. - 95.14Z - 109.14 U.T. - 109.14Z				
9	718047	Cilindretto comando disinnesto / <i>Slave cylinder</i>		4848576 4770993
10	718046	Cilindro maestro comando disinnesto / <i>Master cylinder</i>		4797845
11	717068	Leva a forcella disinnesto / <i>Withdrawal lever</i>	65.12 TURBO Z - 79.12 TURBO Z 79.14 U.T. - 95.14/.14Z - 109.14/.14Z	8586051 8584071
12	728543	Manicotto portareggispinta con cuscinetto / <i>Withdrawal sleeve assy</i>	50.9Z - 60.11 TURBO Z - 65.9Z	8587214
3 60/65NC - 70NC - 75NC 50.9/F9 - 50.10/F10 - 55.9/F9 - 55.10/F10 60.10/F10 - 65.10/F10 - 70.10/F10 - 75.10/F10 - 79.10/F10				
13	718038	Cilindretto comando disinnesto / <i>Slave cylinder</i>		4311345 4191164
14	718047	Cilindretto comando disinnesto / <i>Slave cylinder</i>	U.T.	4848576 4770993
15	718046	Cilindro maestro comando disinnesto / <i>Master cylinder</i>		4797845 4217083
16	716591	Manicotto portareggispinta nudo / <i>Release bearing carrier</i>		-
17	716592	Manicotto portareggispinta con cuscinetto / <i>Withdrawal sleeve assy</i>		8582291
18	732003	Molla richiamo manicotto portareggispinta / <i>Return spring</i>	60/65NC - 70NC - 75NC 75.10/F10 - 79.10/F10	541369
19	728527	Reggispinta distacco / <i>Thrust bearing</i>	∅ 50x84,2x22 60/65NC - 70NC - 75NC	541743
20	728529	Reggispinta distacco (SKF 630086) / <i>Thrust bearing</i>	∅ 50x81,7x22 50.9/F9 - 50.10/F10 - 55.9/F9 55.10/F10 - 60.10/F10 - 65.10/F10 70.10/F10 - 75.10/F10 - 79.10/F10	4614120
4 645/650 N2/ N3 - 655 662 N2/ N3				
21	718043	Cilindretto comando disinnesto / <i>Slave cylinder</i>		4271838 4221755
22	718007	Cilindro maestro comando disinnesto / <i>Master cylinder</i>		4657683 4146273
23	716563	Manicotto portareggispinta / <i>Withdrawal sleeve</i>		-
24	716565	Manicotto portareggispinta con cuscinetto / <i>Withdrawal sleeve assy</i>		4605262
25	732003	Molla richiamo manicotto / <i>Return spring</i>		991701
26	728522	Reggispinta distacco (SKF 615644) / <i>Thrust bearing</i>	∅ 60x97x24	1905136 4614121

1

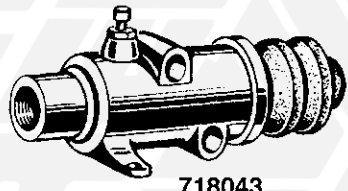

718043
1

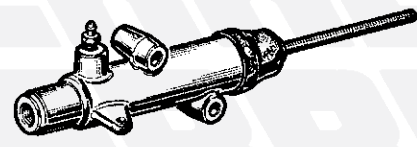

718038
2

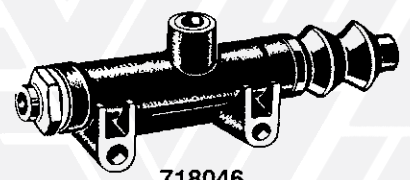

718046
3

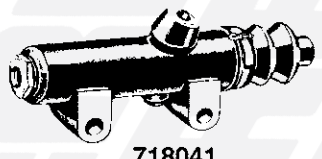

718041
4

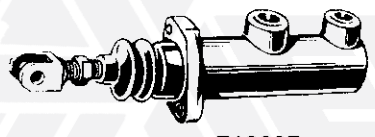

718007
5

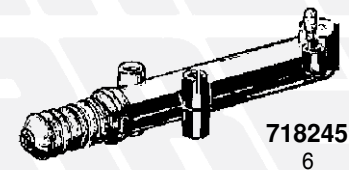

718245
6

NEW



716563
7

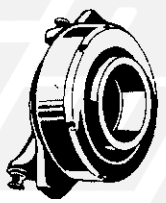

716565
8

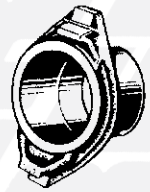

716589
9

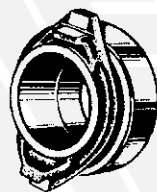

716590
10

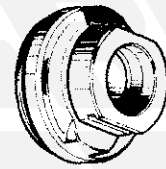

716594
11

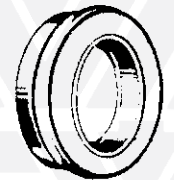

728522
12

2

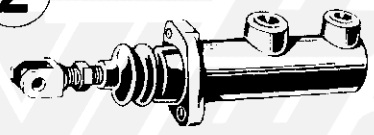

718217
13



717067
14



728260
15

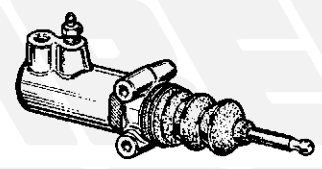

718216
16

3

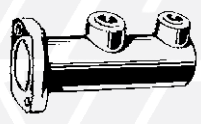

718007
17

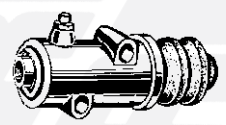

718243
18



732029
19



731721
20



728260
21

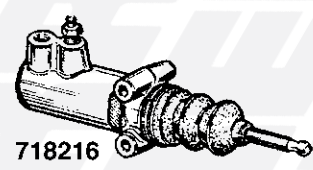

718216
22

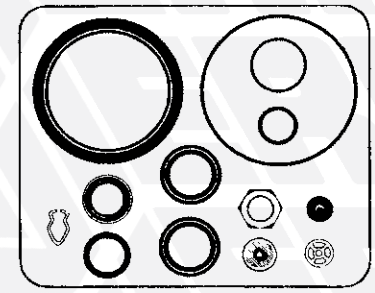

711280
23

4

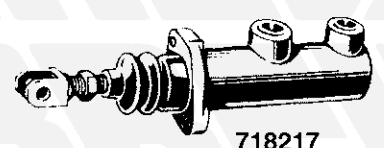

718217
24

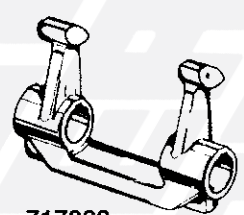

717060
25



731721
26

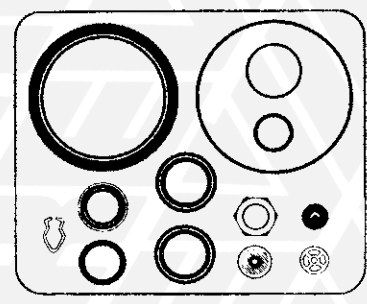

711280
27

FIG. ITEM	RIF. ERREVI ERREVI REF.	DESCRIZIONE PARTICOLARI DESCRIPTION	TIPO VEHICLE MODEL	RIF. ORIG. ORIG. REF.
1 80NC - 90NC - 100NC - 110NC - 110.14 80.14 - 80.16 - 79.13/F13 - 80.13/F13 90.13/F13 - 100.13/F13				
1	718043	Cilindretto comando disinnesto / <i>Slave cylinder</i>	80NC - 90NC - 100NC - 110NC 110.14 - 80.14 - 80.16	4295958 4271838
2	718038	Cilindretto comando disinnesto 2ª Serie / <i>Slave cylinder</i>	80NC - 90NC - 79.13/F13 80.13/F13 - 90.13/F13 - 100.13/F13	4191164
3	718046	Cilindro maestro comando disinnesto / <i>Master cylinder</i>	80NC - 90NC - 79.13/F13 80.13/F13 - 90.13/F13 - 100.13/F13	4797845 4217083
4	718041	Cilindro maestro comando disinnesto / <i>Master cylinder</i>	80.14 - 80.16	4292543
5	718007	Cilindro maestro comando disinnesto / <i>Master cylinder</i>	100NC - 110NC - 110.14	4657683
6	718245	Cilindro comando frizione / <i>Clutch cylinder</i>	90.17WM	4848578 4810692
7	716563	Manicotto portareggispinta / <i>Withdrawal sleeve</i>	80NC - 90NC - 100NC - 110NC 110.14 - 80.14 - 80.16	-
8	716565	Manicotto portareggispinta con cuscinetto <i>Withdrawal sleeve assy</i>	80NC - 90NC - 100NC - 110NC 110.14 - 80.14 - 80.16	4605262
9	716589	Manicotto portareggispinta 2ª Serie / <i>Withdrawal sleeve</i>	80NC - 90NC - 100NC - 110NC 79.13/F13 - 80.13/F13 90.13/F13 - 100.13/F13	-
10	716590	Manicotto portareggispinta con cuscinetto <i>Withdrawal sleeve assy</i>	80NC - 90NC - 100NC - 110NC 79.13/F13 - 80.13/F13 90.13/F13 - 100.13/F13	8564269
11	716594	Manicotto distacco frizione con reggispinta <i>Withdrawal sleeve assy</i>	75.13 - 80.13 - 90.13 - 110.13 - 130.13	42061921 2475547 2565803 42003396
12	728522	Reggispinta distacco (RIV 615644) / <i>Thrust bearing</i>	∅ 60x97x24	1905136 4614121
2 115.14 - 115.17 - 135.14 - 135.17 145.17 - 175.17				
13	718217	Cilindro maestro comando disinnesto / <i>Master cylinder</i>		4774874
14	717067	Leva a forcella disinnesto / <i>Withdrawal lever</i>		4773745
15	728260	Perno con sfera appoggio leva disinnesto / <i>Ball pin</i>		4577306
16	718216	Pompa disinnesto frizione / <i>Master cylinder</i>	115.17 - 135.14/ .17 - 145.17	4777521 4769389
3 130NC - 150NC20 - 159.20				
17	718007	Cilindro maestro comando disinnesto / <i>Master cylinder</i>		4657683 4219866
18	718243	Cilindro comando frizione / <i>Clutch cylinder</i>		4271840 4221757
19	732029	Molla richiamo manicotto / <i>Sleeve spring</i>		4607761
20	731721	Membrana completa / <i>Diaphragm c/w pin</i>		9921881
21	728260	Perno con sfera appoggio leva disinnesto / <i>Ball pin</i>		4577306
22	718216	Pompa disinnesto frizione / <i>Master cylinder</i>	150NC20 - 159.20	4777521 4769389
23	711280	Serie guarnizioni e valvole per revisione servofrizione / <i>Repair kit</i>		9981242
4 165.24R/ .24T - 175.24R/ .24T				
24	718217	Cilindro maestro comando disinnesto / <i>Master cylinder</i>		4774874 4756348
25	717060	Leva disinnesto / <i>Withdrawal lever</i>		4702081
26	731721	Membrana completa / <i>Diaphragm c/w pin</i>		9921881
27	711280	Serie guarnizioni e valvole per revisione servofrizione / <i>Repair kit</i>		9981242
28	731719	Valvolina / <i>Valve</i>		9921880

1

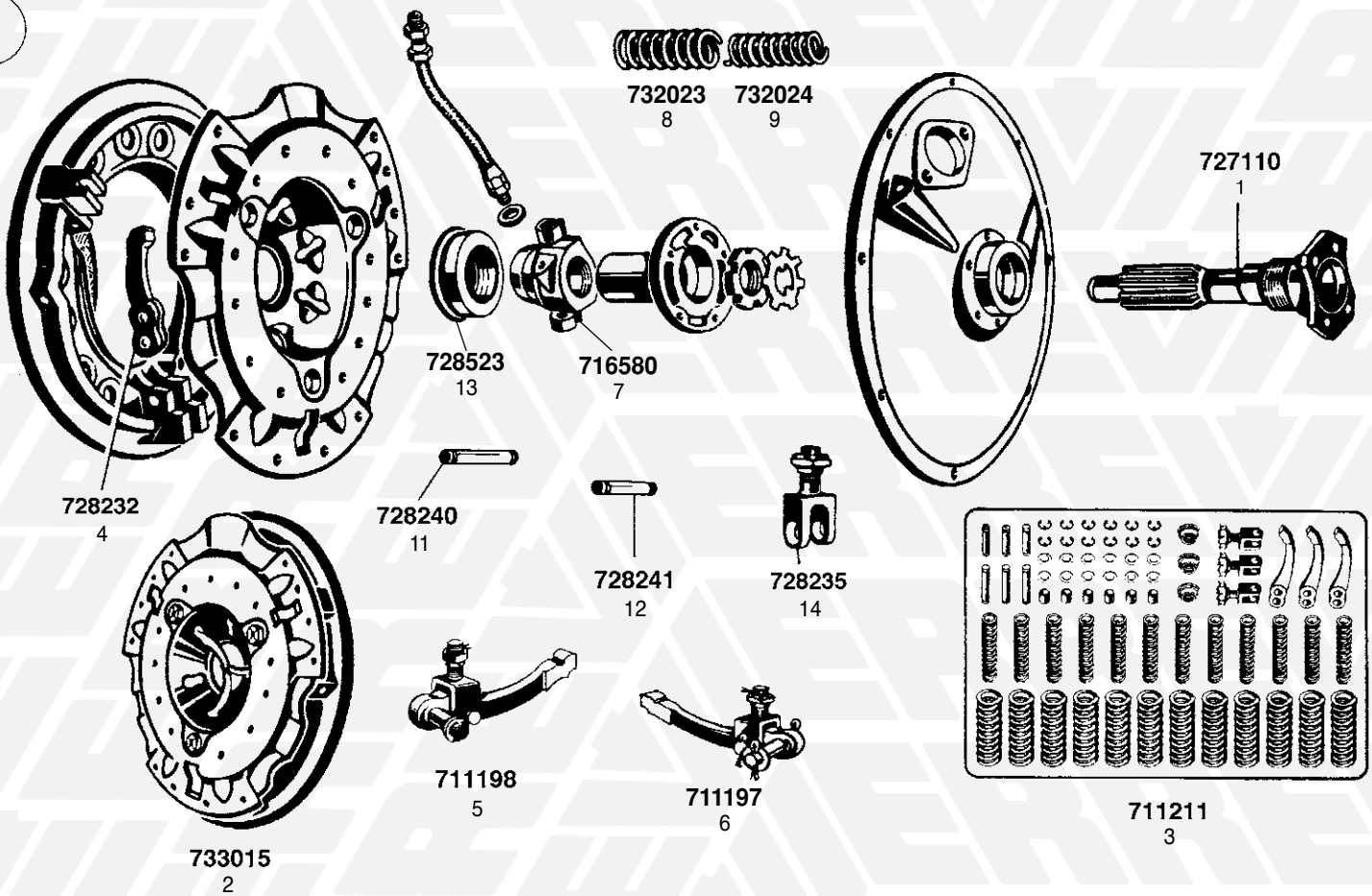

2

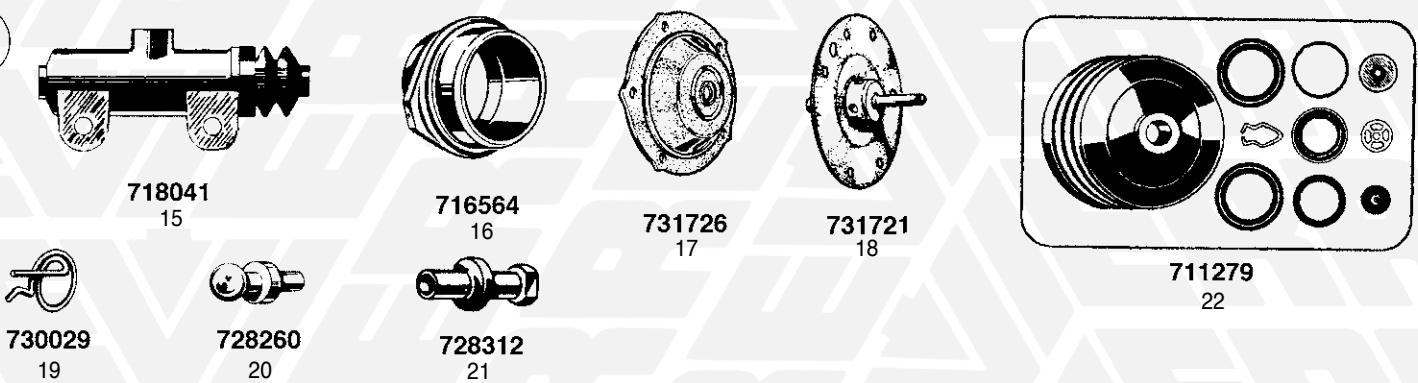

3

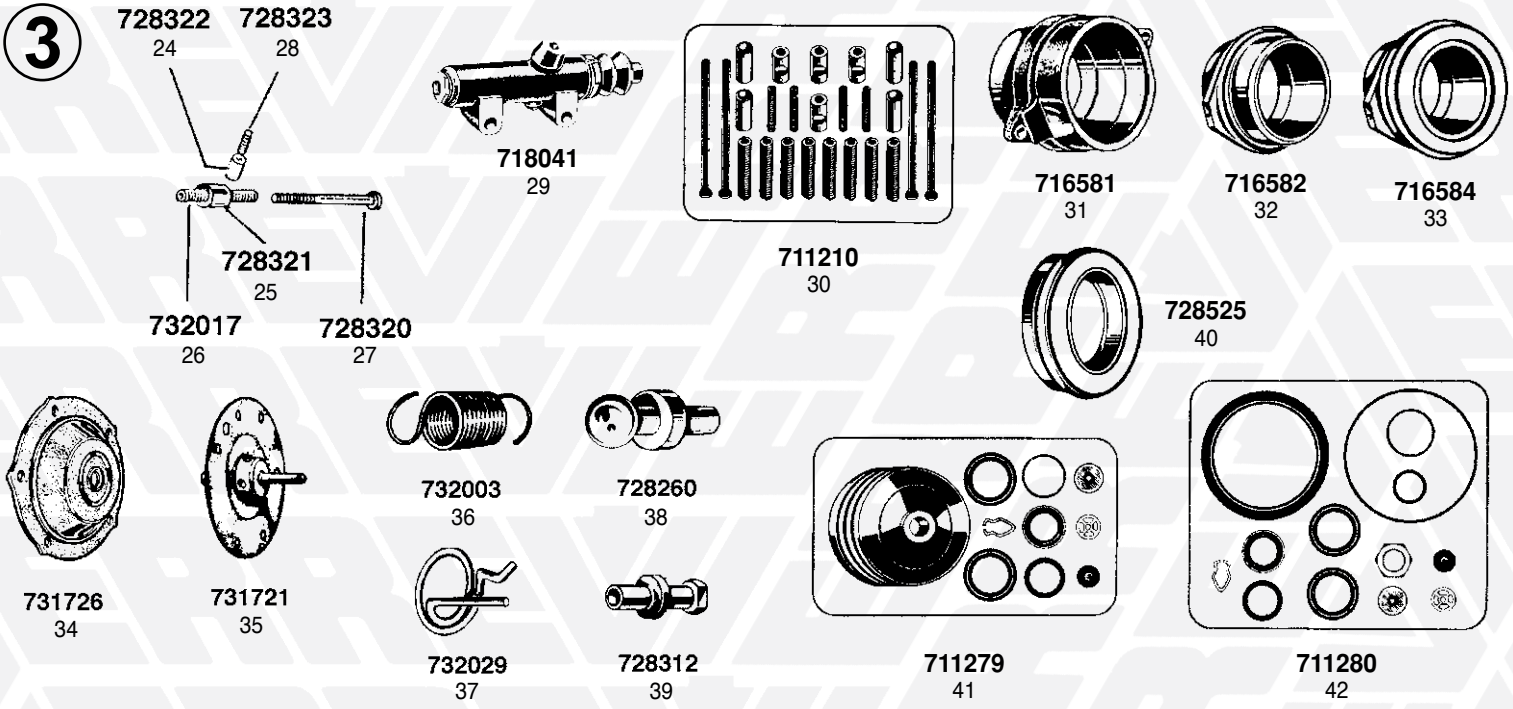
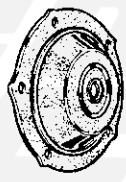

FIG. ITEM	RIF. ERREVI ERREVI REF.	DESCRIZIONE PARTICOLARI DESCRIPTION	TIPO VEHICLE MODEL	RIF. ORIG. ORIG. REF.
1 682N3 - 682N4 - 682T3 - 682T4				
1	727110	Albero frizione rinforzato / <i>Shaft</i>		880878
2	733015	Complessivo frizione equilibrato / <i>Sub-assembly</i>		-
3	711211	Complessivo revisione frizione composto da: Repair kit, inclusive of: levette - supporti - perni - mollette - molle spingidisco <i>fingers - eyebolts - eyebolt pins - springs - outer and inner springs</i>		-
4	728232	Levetta distacco / <i>Finger</i>		4550884
5	711198	Levetta completa montata con seeger / <i>Finger assy</i>		-
6	711197	Levetta completa montata con copiglie / <i>Finger assy</i>		-
7	716580	Manicotto portareggispinta / <i>Withdrawal sleeve</i>		4561428
8	732023	Molla esterna spingidisco / <i>Outer spring</i>		4036875
9	732024	Molla interna spingidisco / <i>Inner spring</i>		4036876
10	732022	Molla per supportino levetta / <i>Spring</i>		670366
11	728240	Perno per supp. levetta lungo con scanalatura seeger / <i>Release lever pin</i>	ø 12x54	4561424
12	728241	Perno per supp. levetta corto con scanalatura seeger / <i>Release lever pin</i>	ø 12x43	4561425
13	728523	Reggispinta distacco (606297 RIV) / <i>Thrust bearing</i>	ø 65x95,5x22,5	894827
14	728235	Supporto per levetta con dado / <i>Finger support c/w nut</i>		-
2 684N/NP - 160NC/NT				
15	718041	Cilindro maestro comando disinnesto / <i>Master cylinder</i>		4292543 4241597
16	716564	Manicotto portareggispinta / <i>Withdrawal sleeve</i>		4672298 4629910
17	731726	Membrana per stantuffo / <i>Diaphragm</i>		9925656
18	731721	Membrana completa / <i>Diaphragm c/w pin</i>		9921881
19	732029	Molla richiamo manicotto disinnesto / <i>Sleeve spring</i>		4607761
20	728260	Perno a sfera appoggio leva disinnesto / <i>Ball pin</i>		4577306
21	728312	Registro per puntone disinnesto / <i>Clevis</i>		4641784
22	711279	Serie guarnizioni e valvoline per revisione servofrizione / <i>Repair kit</i>		9921884
23	731719	Valvolina / <i>Valve</i>		9921880
3 180NC - 619N1 300PC				
24	728322	Boccolina per guida vite / <i>Ferrule</i>		9917866
25	728321	Boccolina per molletta / <i>Ferrule</i>		9918072
26	732017	Molla per boccolina / <i>Ferrule spring</i>		9918071
27	728320	Pernetto per boccolina con molla / <i>Pin</i>		9927586 9917867
28	728323	Vite per boccolina di guida / <i>Dowel</i>		9917865
29	718041	Cilindro maestro comando disinnesto / <i>Master cylinder</i>		4292543 4700150
30	711210	Complessivo pernetti e boccoline per spingidisco intermedio: Repair kit: 4 pernetti - 4 boccoline - 4 boccoline per viti - 4 viti - 8 mollette <i>4 pins - 4 ferrules - 4 bushings - 4 screws - 8 springs</i>		-
31	716581	Manicotto portareggispinta / <i>Withdrawal sleeve</i>		4517066
32	716582	Manicotto portareggispinta / <i>Withdrawal sleeve</i>		4672296 4624483
33	716584	Manicotto portareggispinta con cuscinetto / <i>Withdrawal sleeve assy</i>		-
34	731726	Membrana per stantuffo / <i>Diaphragm</i>		9925656
35	731721	Membrana completa / <i>Diaphragm c/w pin</i>		9921881
36	732003	Molla richiamo manicotto / <i>Sleeve spring</i>	693N1	4007194
37	732029	Molla richiamo manicotto / <i>Sleeve spring</i>		4607761
38	728260	Perno con sfera appoggio leva disinnesto / <i>Ball pin</i>		4577306
39	728312	Registro per puntone / <i>Clevis</i>		4641784
40	728525	Reggispinta distacco (RIV 630098) / <i>Thrust bearing</i>	ø 75x117x26	4675388 4624485
41	711279	Serie guarnizioni e valvoline per revisione servofrizione / <i>Repair kit</i>		9921884
42	711280	Serie guarnizioni e valvoline per revisione servofrizione / <i>Repair kit</i>	300PC U.T.	9981242
43	731719	Valvolina / <i>Valve</i>		9921880

1



731726
3



731721
4



732029
5



728260
6

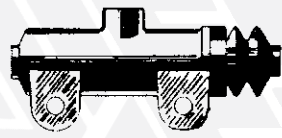

718041
1

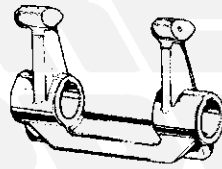

717060
2



731722
7

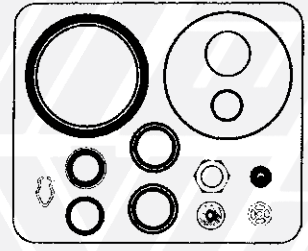

711280
8

2

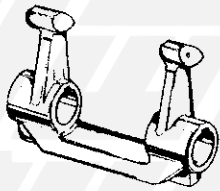

717069
12

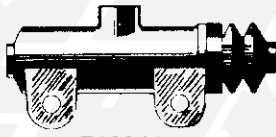

718041
10

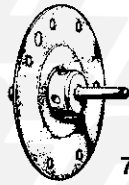

731721
13



731722
14

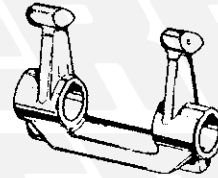

717060
11

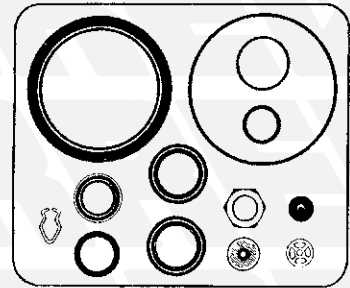

711280
15

3



731721
20

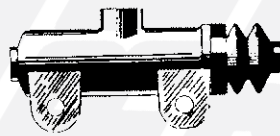

718041
17

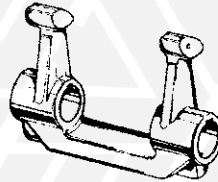

717069
18

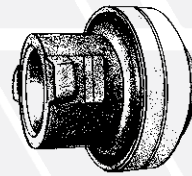

716593
19



731722
21

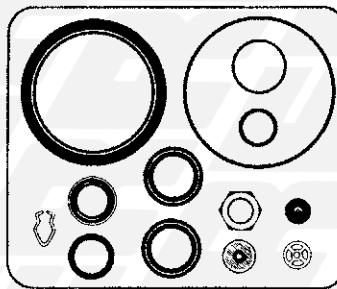

711280
22

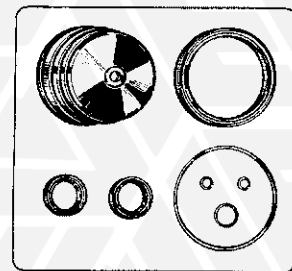

731723
23

4



717059
25

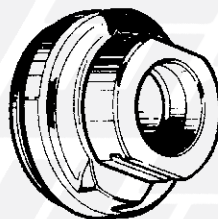

716569
26

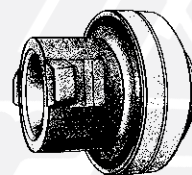

716593
27

FIG. ITEM	RIF. ERREVI ERREVI REF.	DESCRIZIONE PARTICOLARI DESCRIPTION	TIPO VEHICLE MODEL	RIF. ORIG. ORIG. REF.
1 170/190NC26 - NT26 - NC33 - NT33 - 170NC35 - NT35 170/190F26 - F26T - F35 - F35T				
1	718041	Cilindro maestro comando disinnesto / <i>Master cylinder</i>		4292543
2	717060	Leva a forcella disinnesto / <i>Withdrawal lever</i>	170/190NC33 - NT33 170NC35 - NT35 170/190F35 - F35T	4702081
3	731726	Membrana per stantuffo / <i>Diaphragm</i>	170/190NC e derivati	9925656
4	731721	Membrana completa / <i>Diaphragm c/w pin</i>		9921881
5	732029	Molla richiamo manicotto portareggispinta / <i>Sleeve spring</i>	170/190NC26 - NT26 - F26-F26T	4607761
6	728260	Perno con sfera appoggio leva disinnesto / <i>Ball pin</i>	170/190NC26 - NT26 - F26-F26T	4577306
7	731722	Puntale di regolazione per asta servofrizione / <i>Adjusting rod</i>	170/190NC26-NT26-NC33-NT33 170NC35 - NT35	4675799
8	711280	Serie guarnizioni e valvoline per revisione servofrizione / <i>Repair kit</i>	170/190F26 - F26T - F35 - F35T	9981242
9	731719	Valvolina / <i>Valve</i>		9921880
2 180.24/ .24T/ .26 - 190i26/ i26T/ i35/ i35T 190.30 - 220F35T				
10	718041	Cilindro maestro comando disinnesto / <i>Master cylinder</i>	180.26 - 190i26/ i26T/ i35/ i35t 190.30 - 220F35T	4292543
11	717060	Leva a forcella disinnesto / <i>Withdrawal lever</i>	180.24/ .24T/ .26 - 190i35/ i35T 190.30	4702081
12	717069	Leva a forcella disinnesto-CAMBIO ZF- / <i>Withdrawal lever (ZF Gearbox)</i>	190.30	4746189
13	731721	Membrana completa / <i>Diaphragm c/w pin</i>		9921881
14	731722	Puntale di regolazione per asta servofrizione / <i>Adjusting rod</i>	180.26 - 190i26/ i26T/ i35/ i35t 190.30 - 220F35T	4675799
15	711280	Serie guarnizioni e valvoline per revisione servofrizione / <i>Repair kit</i>		9981242
16	731719	Valvolina / <i>Valve</i>		9921880
3 190.33 - 190.42 - 190.38/ .38T - 220.38PT TURBOSTAR				
17	718041	Cilindro maestro comando disinnesto / <i>Master cylinder</i>		4292543
18	717069	Leva a forcella disinnesto / <i>Withdrawal lever</i>	190.38 - 190.33 - 190.36 - 190.42	4746189
19	716593	Manicotto distacco frizione con reggispinta / <i>Withdrawal sleeve assy</i>	190.33 - 190.42	8193332 42062095 93163685
20	731721	Membrana completa / <i>Diaphragm c/w pin</i>		9921881
21	731722	Puntale di regolazione per asta servofrizione / <i>Adjusting rod</i>		4675799
22	711280	Serie guarnizioni e valvoline per revisione servofrizione / <i>Repair kit</i>		9981242
23	731723	Serie guarnizioni per revisione servofrizione U.T. / <i>Repair kit</i>		8124434
24	731719	Valvolina / <i>Valve</i>		9921880
4 330F26/ .26 - 330.30 - 330F35/ .35				
25	717059	Leva a forcella disinnesto / <i>Withdrawal lever</i>		42003011
26	716569	Manicotto distacco c/reggispinta / <i>Withdrawal sleeve assy</i>		42063184 42003473
27	716593	Manicotto distacco frizione con reggispinta <i>Withdrawal sleeve assy</i>	330.26H	8193332 42062095 93163685

**FRIZIONE
CLUTCH**

1

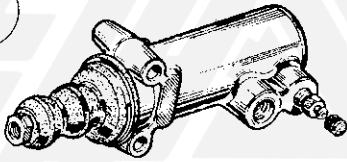

718225
1

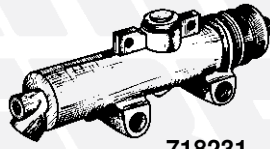

718231
2

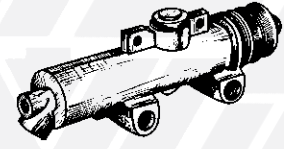

718232
3

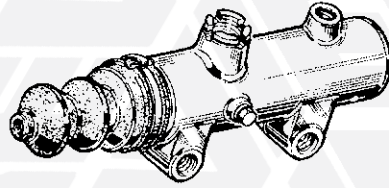

718226 - 718229 - 718242
6 5 4

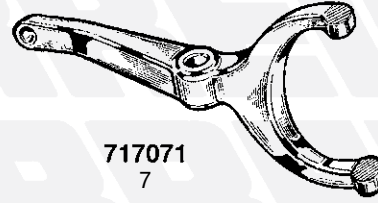

717071
7

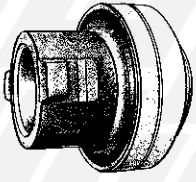

716595
8

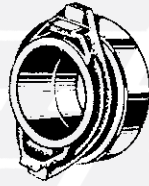

716596
9

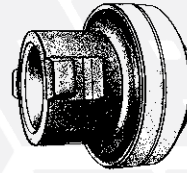

716598
10

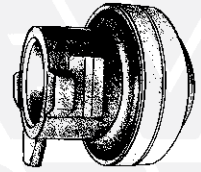

716597
11

2

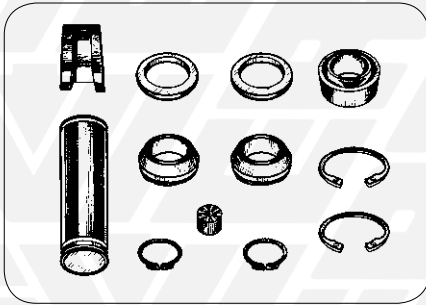

711206
12

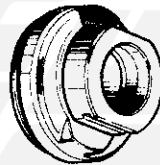

716594
13

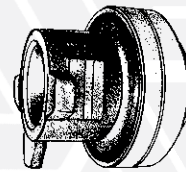

716602
14

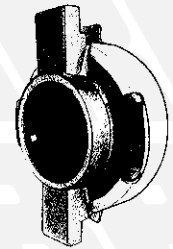

716603
15

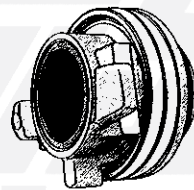

716604
16

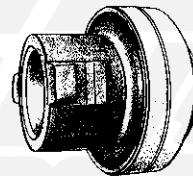

716595
17

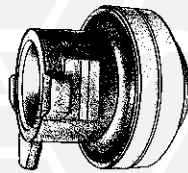

716597
18

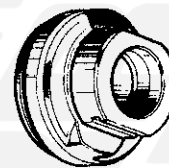

716569
19

FIG. ITEM	RIF. ERREVI ERREVI REF.	DESCRIZIONE PARTICOLARI DESCRIPTION	TIPO VEHICLE MODEL	RIF. ORIG. ORIG. REF.
<div style="display: flex; align-items: center;"> <div style="font-size: 2em; margin-right: 10px;">1</div> <div style="font-size: 2em; font-weight: bold; margin-right: 10px;">IVECO</div> </div> <p> EUROCARGO EUROCARGO "TECTOR" 130E24/E28 - 150E24/E28 - 180E24/E28 - 320E28T EUROTECH EUROSTAR EUROTRAKKER EUROTECH "CURSOR" 190E24/E31/E35 - 260E24/E31/E35 - 440E31/E35 EUROSTAR "CURSOR" 190E43-440E39/E43 EUROTRAKKER "CURSOR" 190E35-260E31/E35 - 340E35-380E35-410E35 </p>				
1	718225	Cilindretto comando disinnesto / <i>Slave cylinder</i>	EUROCARGO	4854828
2	718231	Cilindro comando frizione / <i>Clutch cylinder</i>	EUROTECH - EUROTRAKKER EUROTRAKKER CURSOR - STRALIS	41285355 41211005
3	718232	Cilindro comando frizione / <i>Clutch cylinder</i>	EUROTECH - EUROTRAKKER EUROTRAKKER CURSOR - STRALIS	41285356 41211006
4	718242	Cilindro comando frizione / <i>Clutch cylinder</i>	EUROCARGO 60E14 - 65E14 - 75E14	8604136
5	718229	Cilindro com. disinn. / <i>Master cylinder</i>	ø pist. 28 piston ø 28 EUROCARGO	4853409
6	718226	Cilindro com. disinn. / <i>Master cylinder</i>	ø pist. 34 piston ø 34	4853408
7	717071	Leva forcella disinnesto / <i>Withdrawal lever</i>	EUROCARGO	42115302
8	716595	Manicotto distacco frizione con reggispinta / <i>Withdrawal sleeve assy</i>	EUROCARGO - EUROCARGO "Tector" EUROTECH - EUROSTAR EUROTRAKKER - STRALIS	500305439
9	716596	Manicotto distacco frizione con reggispinta / <i>Withdrawal sleeve assy</i>	EUROTECH	1905470 42061853 42102316
10	716598	Manicotto distacco frizione con reggispinta / <i>Withdrawal sleeve assy</i>	EUROTECH - EUROSTAR EUROTRAKKER EUROTRAKKER "Cursor" - STRALIS	504070593 500335068
11	716597	Manicotto distacco frizione con reggispinta / <i>Withdrawal sleeve assy</i>	EUROTRAKKER - STRALIS	504237895
<div style="display: flex; align-items: center;"> <div style="font-size: 2em; margin-right: 10px;">2</div> <div style="font-size: 2em; font-weight: bold; margin-right: 10px;">MAN</div> </div>				
12	711206	Complessivo revisione distacco frizione / <i>Clutch release fork repair kit</i>	L2000 - M2000 - TGA - TGL - TGM	81305606019 81305606022
13	716594	Manicotto distacco frizione con reggispinta / <i>Withdrawal sleeve assy</i>	M90 - L2000	81305500044 81305500060
14	716602	Manicotto distacco frizione con reggispinta / <i>Withdrawal sleeve assy</i>	F90 - F2000 - TGA - TGS - TGX	81305500087 81305500063 81305500067 81305500071 81305500073 81305500077 81305500088 81305500110 81305500116
15	716603	Manicotto distacco frizione con reggispinta / <i>Withdrawal sleeve assy</i>	F2000 - TGA - TGS - TGX	81305500085 81300007220
16	716604	Manicotto distacco frizione con reggispinta / <i>Withdrawal sleeve assy</i>	M2000 - TGL - TGM	81305500082
17	716595	Manicotto distacco frizione con reggispinta / <i>Withdrawal sleeve assy</i>	TGA - TGM - TGS - TGX	81305500096 81305500097 81305500104 81305500114
18	716597	Manicotto distacco frizione con reggispinta / <i>Withdrawal sleeve assy</i>	TGA - TGM - TGS - TGX	81305500251 81305500255 81305500249
19	716569	Manicotto distacco frizione con reggispinta / <i>Withdrawal sleeve assy</i>	BUS	81305500069 81305500078

1

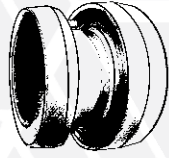

716606
1

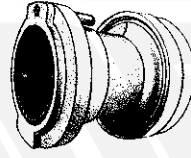

716607
2

2

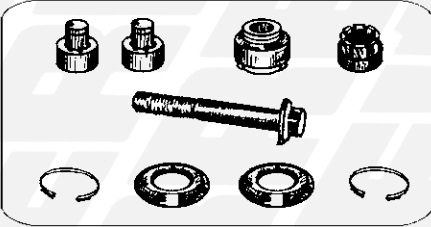

711203
3

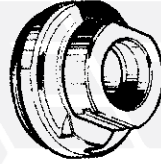

716594
4

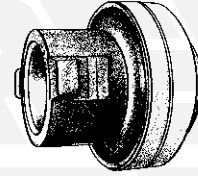

716595
5

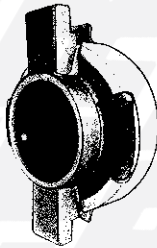

716603
6

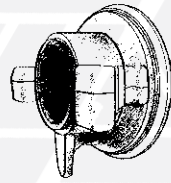

716608
7



716609
8

3

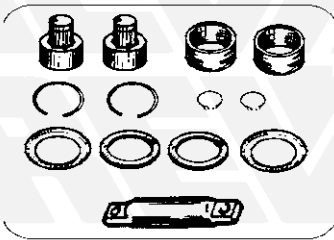

711212
9

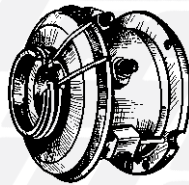

718233
10

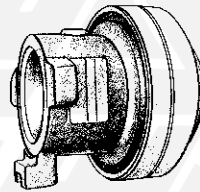

716611
11

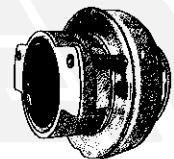

716613
12

4

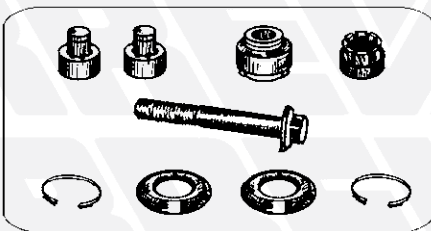

711203
13

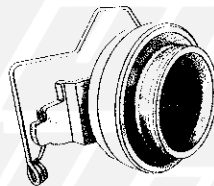

716614
14

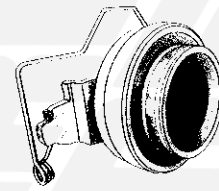

716615
15

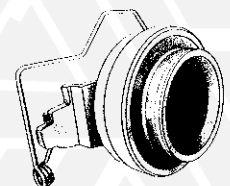

716616
16

FIG. ITEM	RIF. ERREVI ERREVI REF.	DESCRIZIONE PARTICOLARI DESCRIPTION	TIPO VEHICLE MODEL	RIF. ORIG. ORIG. REF.
<h2>1 MERCEDES</h2>				
1	716606	Manicotto distacco frizione con reggispinta / <i>Withdrawal sleeve assy</i>	ATEGO AXOR - AXOR 2 ACTROS - ACTROS MP2	0022503715 0022509915
2	716607	Manicotto distacco frizione con reggispinta / <i>Withdrawal sleeve assy</i>	ATEGO AXOR - AXOR 2 ACTROS - ACTROS MP2	0022504115 0022506715 0022508115 0022509815
<h2>2 RENAULT</h2>				
3	711203	Complessivo revisione frizione / <i>Clutch release fork, repair kit</i>	MAGNUM - PREMIUM	74208062125
4	716594	Manicotto distacco frizione con reggispinta / <i>Withdrawal sleeve assy</i>	MIDLINER	5000613650 5000058221 5000240864 5000677075 5001866623 5001866625
5	716595	Manicotto distacco frizione con reggispinta / <i>Withdrawal sleeve assy</i>	PREMIUM MAGNUM	5001873287 5001864270 5010245921
6	716603	Manicotto distacco frizione con reggispinta / <i>Withdrawal sleeve assy</i>	PREMIUM - MAGNUM MAGNUM E.TECH - KERAX	5010452025 5010545676
7	716608	Manicotto distacco frizione con reggispinta / <i>Withdrawal sleeve assy</i>	PREMIUM - MAGNUM - KERAX	5010244086 5010244204
8	716609	Manicotto distacco frizione con reggispinta / <i>Withdrawal sleeve assy</i>	PREMIUM - MAGNUM - KERAX	5010244202 5010244017
<h2>3 SCANIA</h2>				
9	711212	Complessivo revisione frizione / <i>Clutch release fork, repair kit</i>	Serie P - G - R - T Series Serie 4 Series	1737306S
10	718233	Dispositivo disinnesto frizione / <i>Clutch disconnecting</i>	Serie 4 Series	551572 1123296 1393332 1434649 1455730 1522377
11	716611	Manicotto distacco frizione con reggispinta / <i>Withdrawal sleeve assy</i>	93 - 113 - 143	1393163 1321260
12	716613	Manicotto distacco frizione con reggispinta / <i>Withdrawal sleeve assy</i>	94 - 114 - 124 - 144 - 164	1749125 1728165 1851631
<h2>4 VOLVO</h2>				
13	711203	Complessivo revisione frizione / <i>Clutch release fork, repair kit</i>	FM7 - FM12 FH12 - FH16	20806212S 3191967S
14	716614	Manicotto distacco frizione con reggispinta / <i>Withdrawal sleeve assy</i>	FL10 - FL12 FM9 - FM12 FH12 - FH16 B10	1655843 1668921 1672944 20569157
15	716615	Manicotto distacco frizione con reggispinta / <i>Withdrawal sleeve assy</i>	FL12 FM7 - FM9 - FM10 - FM12 FH12	3192217 1655732 1667258
16	716616	Manicotto distacco frizione con reggispinta / <i>Withdrawal sleeve assy</i>	FM7 - FM12 FH12	3192221 1521767 20569155