

# MOTORE / ENGINE

## RICAMBI PER / SPARE PARTS FOR

<b>DAF</b>	pag.	12 - 13
<b>IVECO</b>	pag.	14 - 35
<b>MAN</b>	pag.	36 - 37
<b>MERCEDES</b>	pag.	36 - 37
<b>RENAULT</b>	pag.	38 - 39
<b>SCANIA</b>	pag.	40 - 41
<b>VOLVO</b>	pag.	42 - 43
<b>IVECO Ricambi per compressori</b> <b>IVECO Compressor parts</b>	pag.	44 - 46

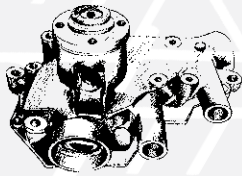

717644  
1



717680  
2

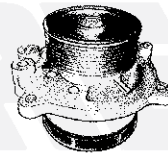

717675  
3



730996  
4

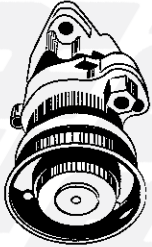

717524  
5

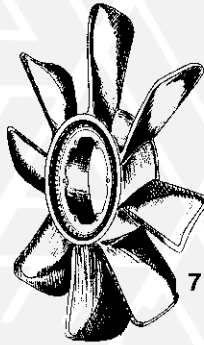

717212  
6

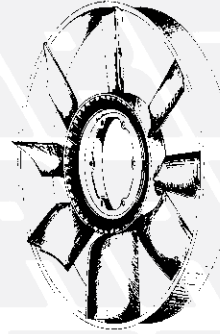

717241  
7

**NEW**

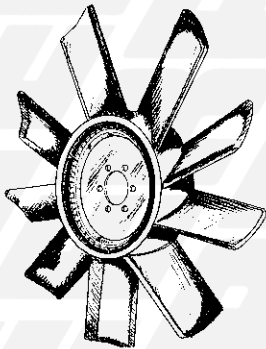

717213  
8

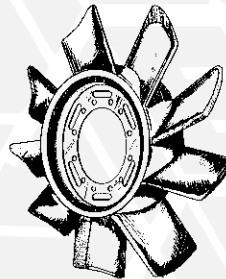

717214  
9

FIG. ITEM	RIF. ERREVI ERREVI REF.	DESCRIZIONE PARTICOLARI DESCRIPTION		TIPO VEHICLE MODEL	RIF. ORIG. ORIG. REF.
<b>DAF</b>					
1	<b>717644</b>	Pompa acqua completa / <i>Complete water pump</i>		CF85 - XF95 - F95	683225 683386 1609871
2	<b>717680</b>	Pompa acqua completa / <i>Complete water pump</i>		CF85 - XF95 - 95XF	683579 1609853 1399150
3	<b>717675</b>	Pompa acqua completa / <i>Complete water pump</i>		XF95 - XF105	1664762 1747962 1778280 1828141 1828162
4	<b>730996</b>	Supporto tubo impianto scarico / <i>Pipe exhaust system mounting</i>		45FA	285530 651183
5	<b>717524</b>	Tendicinghia completo / <i>Belt stretcher</i>		CF85 - XF95	1628148 1614978
6	<b>717212</b>	Ventilatore a 8 pale / <i>8-Blades fan</i>	ø 180/730	CF85 - XF95 - XF105 FA/FT	1315854
7	<b>717241</b>	Ventilatore a 8 pale / <i>8-Blades fan</i>	ø est 704	65CF - 75CF - 85CF CF75 - CF85	1448197 1399180 1733234 1308285
8	<b>717213</b>	Ventilatore a 9 pale / <i>9-Blades fan</i>	ø 68/620	2800	505347
9	<b>717214</b>	Ventilatore a 9 pale / <i>9-Blades fan</i>	ø 125/620	3300	655158

**MOTORE ENGINE**

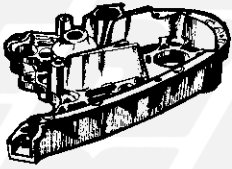

717669  
1

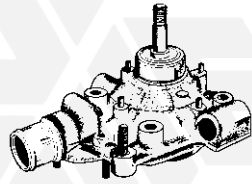

717677  
2

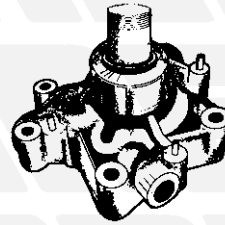

717678  
3

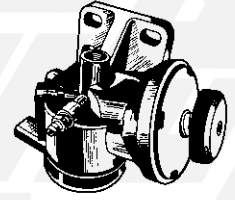

717682  
4

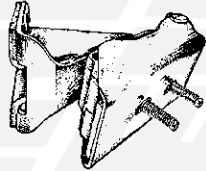

6 - 730899 **NEW**

7 - 730898 **NEW**

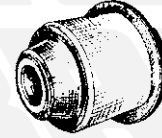

730895  
8

**NEW**

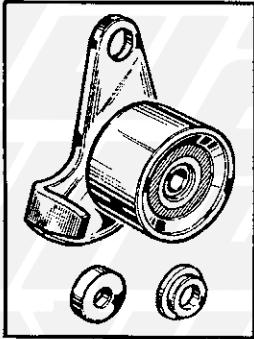

717514  
9

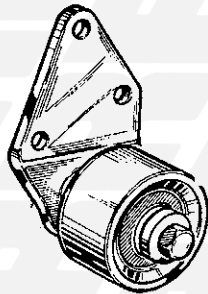

717515  
10



719002  
11



730086  
12



730346  
13

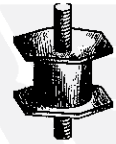

730395  
14



730274  
15



730924  
16



730925  
17



717532  
18



717523  
19

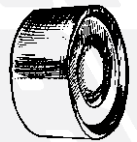

717558  
5

**NEW**

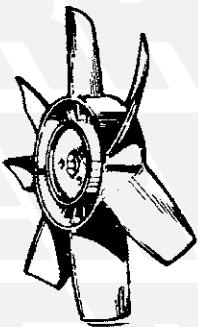

717205  
20

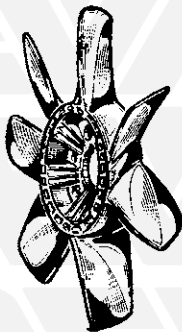

717208  
21

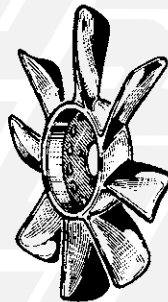

717207  
22

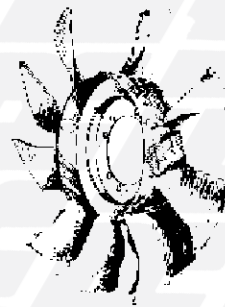

717238  
23

**NEW**

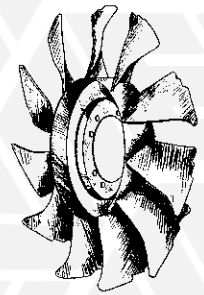

717218  
24

FIG. ITEM	RIF. ERREVI ERREVI REF.	DESCRIZIONE PARTICOLARI DESCRIPTION	TIPO VEHICLE MODEL	RIF. ORIG. ORIG. REF.
<b>IVECO</b> <b>DUCATO - DAILY 30.8 - 32.8 - 35.8 - 40.8 - NEW DAILY 30.8 - 35.8 - 40.8</b> <b>TURBO DAILY 30.10 - 35.10 - 35.12 - 40.10 - 49.10 - 49.12 - 59.12</b> <b>NEW DAILY ('96) - TURBO DAILY ('96)</b> <b>DAILY CNG - DAILY DUTY - DAILY 2000 - DAILY 2006 - 2009 - 2012</b>				
1	717669	Pompa acqua completa / <i>Water pump assy</i>	DUCATO - DAILY 2000 35C10/C12/C14 35S10/S12/S14 - 40C10/C12/C14	504033770
2	717677	Pompa acqua / <i>Water pump</i> (adattabile a MOTORE / <i>ENGINE TYPE</i> 8140.07 - 8140.27S - 8140.47 - 4 cilindri / <i>cylinders</i> )	NEW DAILY ('96) 30.8 - 35.8/.10 40.8 - 49.10 T. DAILY ('96) 35.12 - 49.12 - 59.12	500361919 500361203 500300476
3	717678	Pompa acqua / <i>Water pump</i>	DAILY 2006 - 2009 - 2012 35C15/C18 - 40C15/C18 45C15/C18 - 50C15/C18 60C15/C18 - 65C15/C18	504369725 504360207 504113544
4	717682	Pompa acqua (con cuscinetto IMI) <i>Water pump (complete with IMI bearing)</i> Adattabile a motore / <i>Engine type</i> 8141 - 8140.61.200 - 8140.07	NEW DAILY 30.8 - 35.8 - 40.8 DAILY DUTY 30.8H - 35.8H - 40.8H	99440728 99440726 98437726
5	717558	Puleggia tendicinghia / <i>Belt stretcher pulley</i>	DAILY - NEW DAILY TURBODAILY DAILY CNG - DAILY DUTY DAILY 2000-2006-2009-2012	500042739 99432547 2992484 2997797
6	730899	Supporto anteriore motore Dx / <i>Front engine mounting RH</i>	DAILY 2000 35C9/C10/C11/C12/ C13/C14/C15/C17 40C13/14C/15 - 50C11/C13/C14/ C15/C17 - 65C14/C15/C17	500342992 504007840
7	730898	Supporto anteriore motore Sx / <i>Front engine mounting LH</i>	DAILY 2000 35C9/C10/C11/C12/ C13/C14/C15/C17 40C13/14C/15 - 50C11/C13/C14/ C15/C17 - 65C14/C15/C17	500342991 504007839
8	730895	Supporto motore / <i>Engine bracket</i>	DAILY 2006-2009-2012 65C11/C13/C14/C15/C17/C18 70C14/C15/C17/C18/C21	61269244
9	717514	Supporto tendicinghia / <i>Belt stretcher bracket</i>	DAILY - NEW DAILY 30.8 - 35.8 - 40.8	7301661
10	717515	Supporto tendicinghia / <i>Belt stretcher bracket</i>	DAILY - NEW DAILY 30.8 - 35.8 - 40.8	7301662
11	719002	Tappo per serbatoio nafta / <i>Filler cap</i>	DAILY 30.8 - 32.8 - 35.8 - 40.8	541257
12	730086	Tassello sostegno tubo scarico / <i>Exhaust strap</i>	DAILY - NEW DAILY - TURBO DAILY	93818454 93806171
13	730346	Tassello sostegno post. motore D/S. <i>Engine mounting pad RH/LH, rear</i>	NEW DAILY 30.8 - 35.8 - 40.8 DAILY DUTY 30.8 - 35.8 - 40.8	93804153
14	730395	Tassello sostegno tubo scarico / <i>Exhaust strap</i>	NEW DAILY TURBODAILY	9060048 4211548
15	730274	Tassello in gomma per silenziatore scarico / <i>Strut</i>	TURBODAILY - NEW DAILY 30.8 - 35.8 DAILY CNG 35.11 - 49.11	93826649
16	730924	Tassello sostegno motore DX / <i>Engine mounting pad RH</i>	NEW DAILY 30.8 - 35.10 T. DAILY 30.10 - 35.10/.12 - 59.12 D. CNG 35.11 - D. DUTY 35.8 - 40.8	8588903 93817663
17	730925	Tassello sostegno motore SX / <i>Engine mounting pad LH</i>	NEW DAILY 30.8 - 35.10 T. DAILY 30.10 - 35.10/.12 - 59.12 D. CNG 35.11 - D. DUTY 35.8 - 40.8	8588904 93817664
18	717532	Tendicinghia completo / <i>Belt stretcher</i>	DAILY CNG 35.11 - 49.11 - 59.11 DAILY 2000/2006 35C9/C11/C13/C15/S9/S11/S13/S15 50C11/C13/C15 - 65C11/C13/C15	500332622
19	717523	Tendicinghia completo / <i>Belt stretcher</i>	DAILY 2006 35C14/C15/C15H/C18 35S14/S15/S18 - 40C14/C15/C15H/ C18 - 50C14/C15/C15H/C18 - 65C14/ C15/C17/C18 - 70C14/C15/C17/C18	504086948
20	717205	Ventilatore a 7 pale / <i>7-Blades fan</i>	NEW DAILY	8586706
21	717208	Ventilatore a 7 pale ( <b>elettroventola</b> ) / <i>7-Blades fan</i>	NEW DAILY - TURBO DAILY	93813264
22	717207	Ventilatore a 8 pale / <i>8-Blades fan</i>	NEW DAILY ('96) - TURBO DAILY ('96)	93811590
23	717238	Ventilatore a 9 pale / <i>9-Blades fan</i>	DAILY 2006 - 2009 - 2012	504154349 504108306
24	717218	Ventilatore a 11 pale / <i>11-Blades fan</i>	DAILY 2000 35C9/C11/C13/C15 35S9/S11/S13/S15 50C11/C15 - 65C13/C15	504024647 500333136

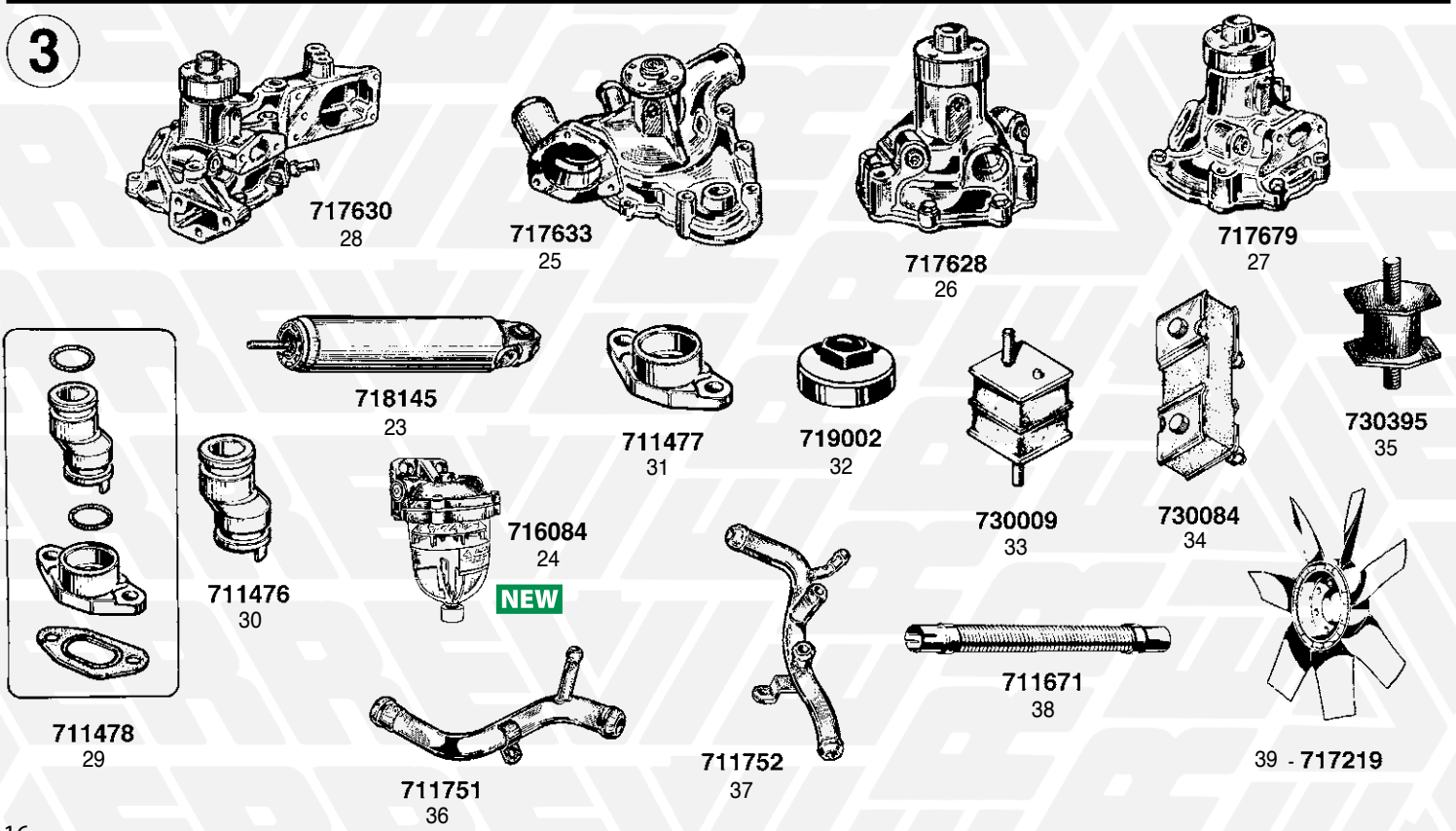
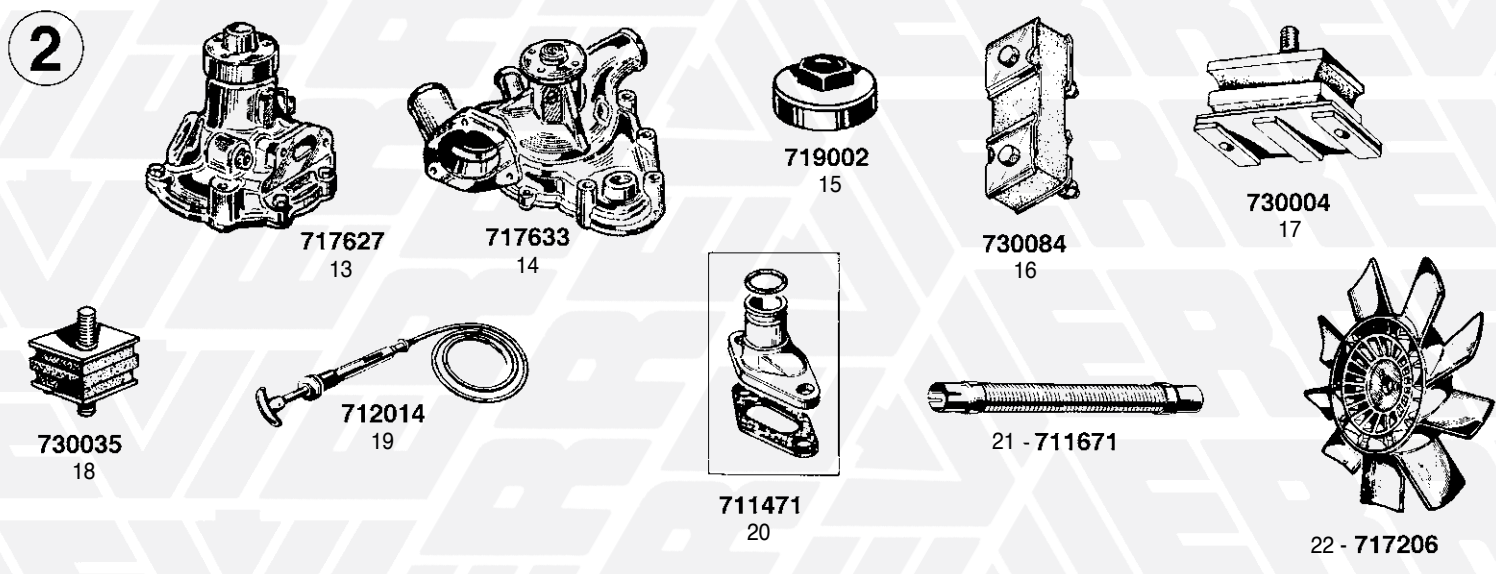
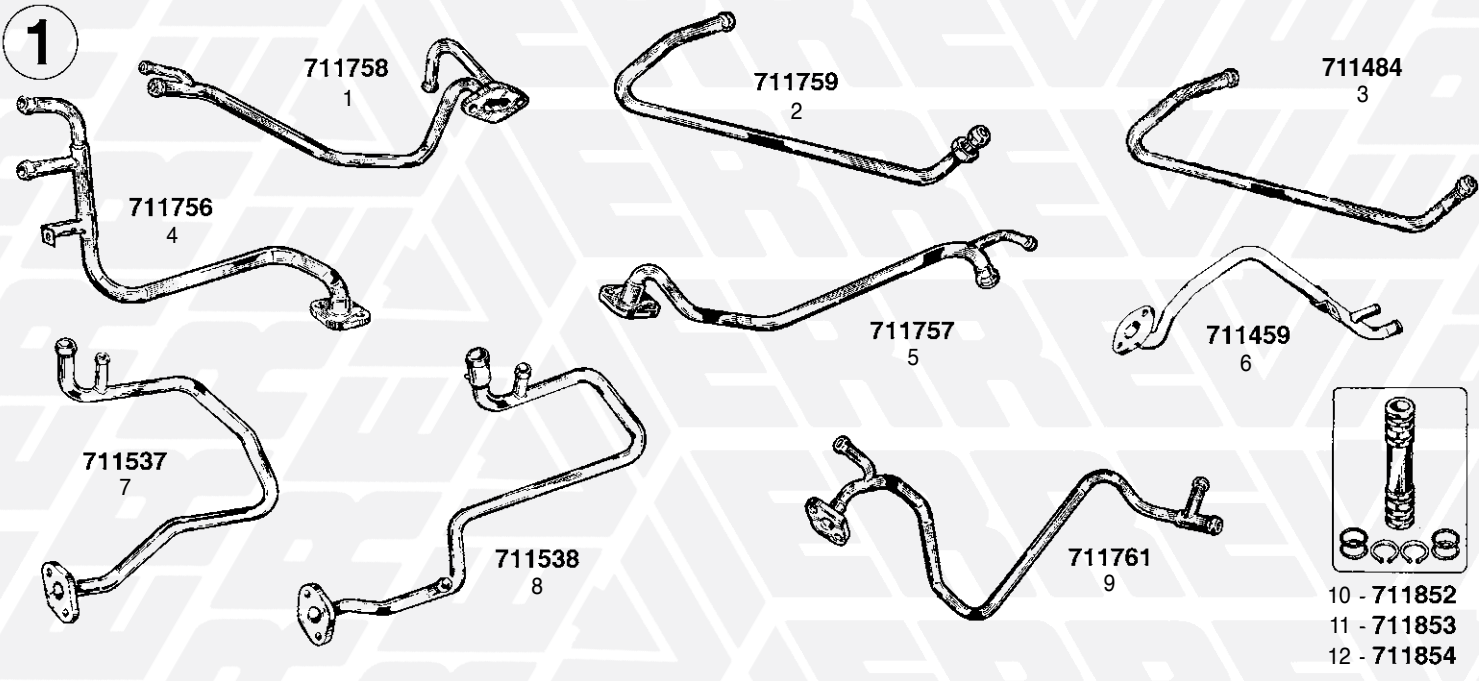
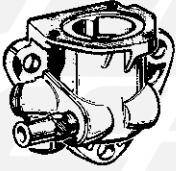

FIG. ITEM	RIF. ERREVI ERREVI REF.	DESCRIZIONE PARTICOLARI DESCRIPTION		TIPO VEHICLE MODEL	RIF. ORIG. ORIG. REF.
<b>1 DAILY</b>					
1	<b>711758</b>	Tubo acqua raffreddamento / <i>Water pipe cooler</i>		NEW DAILY ('96) 30.8 - 35.8	99443658
2	<b>711759</b>	Tubo acqua raffreddamento / <i>Water pipe cooler</i>		NEW DAILY ('96) 30.8 - 35.8 TURBODAILY ('96) 35.12	99482735
3	<b>711484</b>	Tubo acqua raffreddamento / <i>Water pipe cooler</i>		TUTTI I TIPI	98434054
4	<b>711756</b>	Tubo acqua raffreddamento / <i>Water pipe cooler</i>		NEW DAILY 30.8 - 35.8 - 40.8 DAILY DUTY 30.8 - 35.8 - 40.8	4837163
5	<b>711757</b>	Tubo acqua raffreddamento / <i>Water pipe cooler</i>		NEW DAILY 30.8 - 35.8 - 40.8 DAILY DUTY 30.8 - 35.8 - 40.8	98410628
6	<b>711459</b>	Tubo acqua dal serb. alla pompa / <i>Water pipe</i>		DAILY 30.8 - 32.8 - 35.8 - 40.8	93805975
7	<b>711537</b>	Tubo acqua raffreddamento / <i>Water pipe cooler</i>		TURBO DAILY 35.10 - 45.10 - 49.10	7302947
8	<b>711538</b>	Tubo acqua raffreddamento / <i>Water pipe cooler</i>		NEW DAILY - TURBO DAILY	98467958 99457054
9	<b>711761</b>	Tubo acqua raffreddamento / <i>Water pipe cooler</i>		DAILY 2000 35C11/C13	500326396
10	<b>711852</b>	Tubo racc. pompa acqua compl. / <i>Water pump connecting pipe</i>	l. mm. 75	DAILY 30.8 - 32.8 - 35.8 - 40.8	-
11	<b>711853</b>	Tubo racc. pompa acqua compl. / <i>Water pump connecting pipe</i>	l. mm. 80	NEW DAILY - TURBO DAILY	-
12	<b>711854</b>	Tubo racc. pompa acqua compl. / <i>Water pump connecting pipe</i>	l. mm. 85	TUTTI I TIPI	99443808
<b>2 35NC - 40NC - 45NC - 49NC 50/55NC - 50/55.8 - 60.8</b>					
13	<b>717627</b>	Pompa acqua completa / <i>Complete water pump</i> (adattabile a MOTORE 8035.04 - 8035.04.359 - 8055.05.250) (ENGINE TYPE 8035.04-8035.04.359-8055.05.250)		35/40NC - 50NC - 50/55NC 50.8 - 55.8 - 60.8	93191101 4655054 4679242
14	<b>717633</b>	Pompa acqua completa / <i>Complete water pump</i> (adattabile a MOTORE 8340.04) / (ENGINE TYPE 8340.04)		50F8 / F9 / F10 - 55F8 / F9 / F10	4796535 4711706
15	<b>719002</b>	Tappo serbatoio nafta / <i>Filler cap</i>			541257
16	<b>730084</b>	Tassello sostegno tubo scarico compl. / <i>Exhaust strap assy</i>		50.8 - 55.8 - 60.8	-
17	<b>730004</b>	Tassello sostegno ant. motore / <i>Engine mounting pad</i>		35NC - 40NC - 45NC - 49NC	4610904
18	<b>730035</b>	Tassello sostegno ant. e post. motore / <i>Engine mounting pad</i>		50NC - 55NC - 50.8/F8 - 55.8/F8	8557402
19	<b>712014</b>	Tirante completo acceleratore / <i>Throttle control cable</i>		625	4617329
20	<b>711471</b>	Tubo collegamento pompa acqua al supp. portatermostato completo di guarnizione e anello / <i>Water pipe</i>			4673807
21	<b>711671</b>	Tubo flessibile scarico / <i>Exhaust flexible pipe</i>		50.8/F8 - 55.8/F8 - 60.8/F8	8569057
22	<b>717206</b>	Ventilatore a 9 pale / <i>9-Blades fan</i>	ø 28/410	50NC - 55NC - 50.8/F8 - 55.8/F8	4616572 8033778
<b>3 50.9/.10 - 55.9/.10 - 60.10 - 65.10 - 70.10 - 75.10 79.10 - 50.9Z - 60.11 TURBO Z - 65.9Z - 65.12H TURBO Z - 65.12 TURBO Z</b>					
23	<b>718145</b>	Cilindro operatore freno motore / <i>Exhaust brake cylinder</i>		TURBO Z 65.12	41022031
24	<b>716084</b>	Filtro combustibile / <i>Fuel filter</i>		50.9Z - 60.11 TURBO Z 65.12 TURBO Z	4686377 503475937
25	<b>717633</b>	Pompa acqua completa / <i>Complete water pump</i> (adattabile a MOTORE 8340.04) / (ENGINE TYPE 8340.04)		65F10 - 70F10 - 75F10	4796535 4711706
26	<b>717628</b>	Pompa acqua completa / <i>Complete water pump</i> (adattabile a MOTORE 8040.05) / (ENGINE TYPE 8040.05)		50.9Z - 65.9Z 60.11TURBO Z - 65.12 TURBO Z	98497117 98465322
27	<b>717679</b>	Pompa acqua completa / <i>Water pump assy</i> (adattabile a motore 8040.05 - 8060.25) / (ENGINE TYPE 8040.05 - 8060.25)		50.9 Z - 65.9 Z 60.11 TURBO Z - 65.12 TURBO Z	4813370 4784454
28	<b>717630</b>	Pompa acqua completa / <i>Complete water pump</i> (adattabile a MOTORE 8040.25 - 8060.04/.24 - 8060.05.200 - 8060.25.600) (ENGINE TYPE 8040.25 - 8060.04/.24 - 8060.05.200 - 8060.25.600)		60.11 - 65.12	98497115 4835043
29	<b>711478</b>	<b>Kit attacco portatermostato: / <i>Thermostat housing kit:</i></b>			-
30	<b>711476</b>	(1) Raccordo sup. per corpo termostato / <i>Union</i>			4859907
31	<b>711477</b>	(1) Flangia inf. per corpo termostato / <i>Connecting plate</i> (2) O.Ring			4859908 -
		(1) Guarnizione piana / <i>Flat washer</i>			-
32	<b>719002</b>	Tappo per serbatoio nafta / <i>Filler cap</i>			541257
33	<b>730009</b>	Tassello sostegno ant. motore / <i>Engine mounting pad</i>			8573558
34	<b>730084</b>	Tassello sostegno tubo scarico compl. / <i>Exhaust strap assy</i>			-
35	<b>730395</b>	Tassello sostegno tubo scarico / <i>Exhaust strap</i>		50.9Z - 65.9Z 65.11 TURBO Z - 65.12 TURBO Z	9060048 4211548
36	<b>711751</b>	Tubo acqua / <i>Water pipe</i>		65.10 - 70.10 - 75.10	4713436
37	<b>711752</b>	Tubo acqua / <i>Water pipe</i>		TURBO Z 60.11 - 65.12 - 79.12	8591429
38	<b>711671</b>	Tubo flessibile scarico / <i>Exhaust flexible pipe</i>		50.9 - 55.9	8569057
39	<b>717219</b>	Ventilatore a 7 pale / <i>7-Blades fan</i>	ø 80 /420	50.9 Z - 65.9 Z 65.11 /12 - 79.12 TURBO ZETA	4800473

1



711498  
1



712014  
2



718135  
3

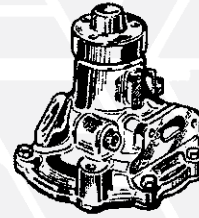

717627  
4

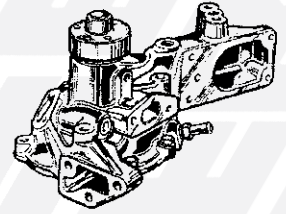

717630  
5



717513  
6



719002  
7



730008  
8



730084  
9



711545  
10



711554  
11



711471  
12



717206  
13

2

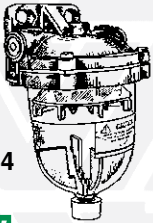

716084  
14  
**NEW**

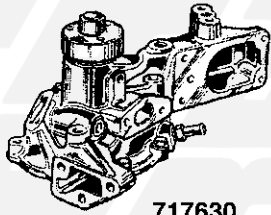

717630  
15

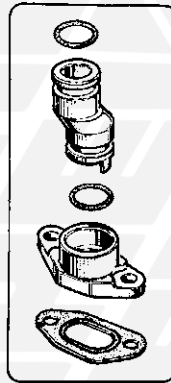

711478  
16



711476  
17



730084  
19



730395  
20

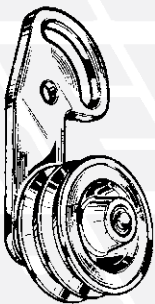

717512  
21



711753  
22



711477  
18

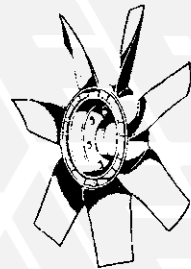

717211  
23

3

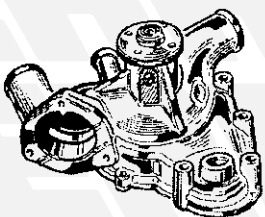

717633  
24

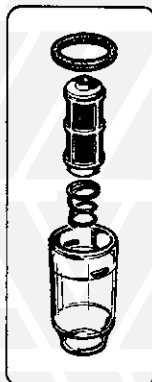

732605  
25

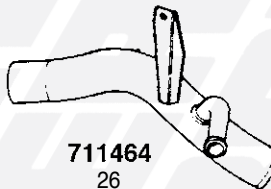

711464  
26

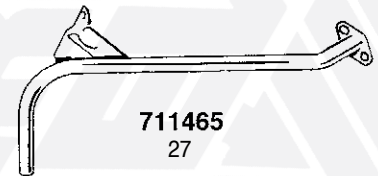

711465  
27



FIG. ITEM	RIF. ERREVI ERREVI REF.	DESCRIZIONE PARTICOLARI DESCRIPTION	TIPO VEHICLE MODEL	RIF. ORIG. ORIG. REF.
<div style="text-align: center;"> <span style="font-size: 2em; border: 1px solid black; border-radius: 50%; padding: 5px;">1</span> <b>79.13 - 80.13 - 90.13 - 100.13 80NC - 90NC - 100NC - 110NC - 110.14</b> </div>				
1	<b>711498</b>	Corpo portatermostato / <i>Thermostat housing</i>	80.14 - 80.16	4626879
2	<b>712014</b>	Comando acceleratore a mano / <i>Throttle control</i>	100NC - 110NC	4667457 4676528
3	<b>718135</b>	Distrib. freno motore (MI) / <i>Exhaust brake distributor</i>		4782794 4604222
4	<b>717627</b>	Pompa acqua completa / <i>Complete water pump</i> (adattabile a MOTORE 8035.04 - 8035.04.359 - 8055.05.250) (ENGINE TYPE 8035.04-8035.04.359-8055.05.250)	75PC - 100NC - 110NC	93191101 4655054 4679242
5	<b>717630</b>	Pompa acqua completa / <i>Complete water pump</i> (adattabile a MOTORE 8040.25 - 8060.04/.24 - 8060.05.200 - 8060.25.600) (ENGINE TYPE 8040.25 - 8060.04/.24 - 8060.05.200 - 8060.25.600)	110.14	98497115 4835043
6	<b>717513</b>	Supporto completo tendicinghia / <i>Belt stretcher</i>		4616156
7	<b>719002</b>	Tappo per serbatoio nafta / <i>Filler cap</i>		541257
8	<b>730008</b>	Tassello sostegno ant. motore / <i>Engine mounting pad</i>		4617444
9	<b>730084</b>	Tassello sostegno tubo scarico compl. / <i>Exhaust strap assy</i>	79.13 - 90.13 - 100.13	-
10	<b>711545</b>	Tubo flessibile scarico / <i>Exhaust flexible pipe</i>	80/90NC - 100/110NC - 110.14	4020316
11	<b>711554</b>	Tubo flessibile scarico / <i>Exhaust flexible pipe</i>	79.13 - 80.13 - 90.13 - 100.13	8569477
12	<b>711471</b>	Tubo collegamento pompa acqua al supporto portatermostato completo di guarnizione e anello / <i>Water pipe</i>	ø 28/410	4673807
13	<b>717206</b>	Ventilatore a 9 pale / <i>9-Blades fan</i>	100NC - 110NC	4616572 8033778
<div style="text-align: center;"> <span style="font-size: 2em; border: 1px solid black; border-radius: 50%; padding: 5px;">2</span> <b>79.14 - 79.14Z - 95.14 - 95.14Z 109.14 - 109.14Z</b> </div>				
14	<b>716084</b>	Filtro combustibile / <i>Fuel filter</i>	79.14Z - 95.14Z - 109.14Z	4686377 503475937
15	<b>717630</b>	Pompa acqua completa / <i>Complete water pump</i> (adattabile a MOTORE 8040.25 - 8060.04/.24 - 8060.05.200 - 8060.25.600) (ENGINE TYPE 8040.25 - 8060.04/.24 - 8060.05.200 - 8060.25.600)	95.14 - 109.14	98497115 4835043
16	<b>711478</b>	<b>Kit attacco portatermostato composto da: Thermostat housing kit:</b>		-
17	<b>711476</b>	(1) Raccordo sup. per corpo termostato / <i>Union</i>		4859907
18	<b>711477</b>	(1) Flangia inf. per corpo termostato / <i>Connecting plate</i>		4859908
		(2) O.Ring		-
		(1) Guarnizione piana / <i>Flat washer</i>		-
19	<b>730084</b>	Tassello sostegno tubo scarico compl. / <i>Exhaust strap assy</i>		-
20	<b>730395</b>	Tassello sostegno tubo scarico / <i>Exhaust strap</i>	79.14Z 95.14Z	9060048 4211548
21	<b>717512</b>	Tendicinghia completo / <i>Belt stretcher</i>	95.14/ .14Z - 109.14/ .14Z	4803462
22	<b>711753</b>	Tubo acqua raffreddamento / <i>Water pipe cooler</i>	79.14Z - 109.14Z	4762766
23	<b>717211</b>	Ventilatore a 7 pale completo / <i>7-Blades fan</i>	ø 80 / 470 79.14Z - 95.14Z - 109.14Z	4800475 4782877
<div style="text-align: center;"> <span style="font-size: 2em; border: 1px solid black; border-radius: 50%; padding: 5px;">3</span> <b>65NC - 70NC - 75NC OM 50/ 55/ 65/ 70/ 75/ 80/ 90</b> </div>				
24	<b>717633</b>	Pompa acqua completa / <i>Complete water pump</i> (adattabile a MOTORE 8340.04) / (ENGINE TYPE 8340.04)	OM 50 - OM 55	4796535 4711706
25	<b>732605</b>	Kit filtro pompa alimentazione / <i>Fuel pump filter kit</i>	Tipo BOSCH	-
26	<b>711464</b>	Tubo inf. pompa acqua / <i>Water pipe, bottom</i>		8826137
27	<b>711465</b>	Tubo dalla pompa al serbatoio / <i>Water pipe</i>		8827468

**MOTORE  
ENGINE**

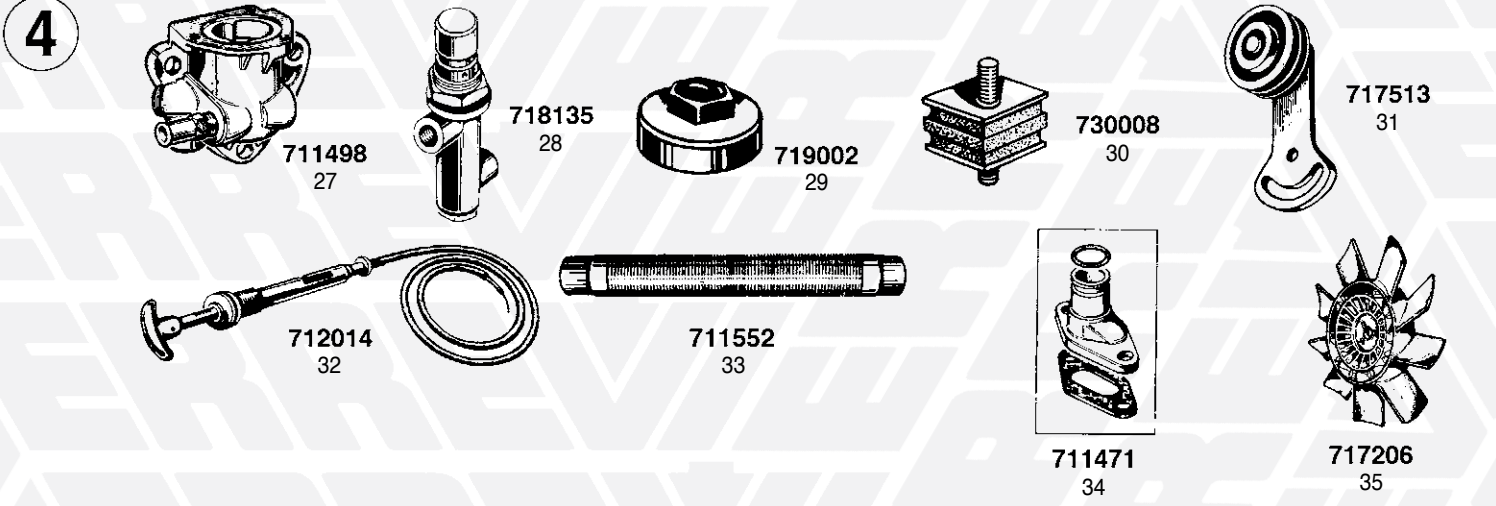
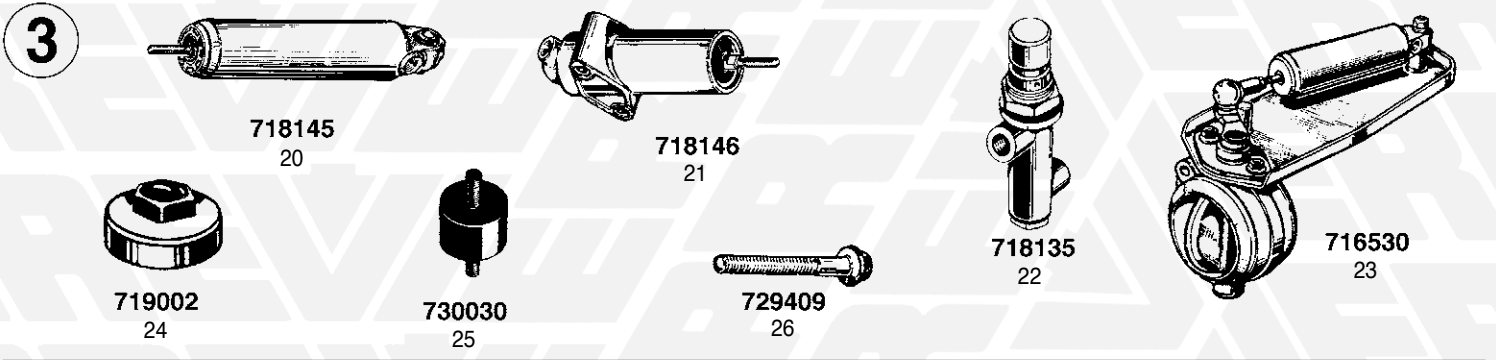
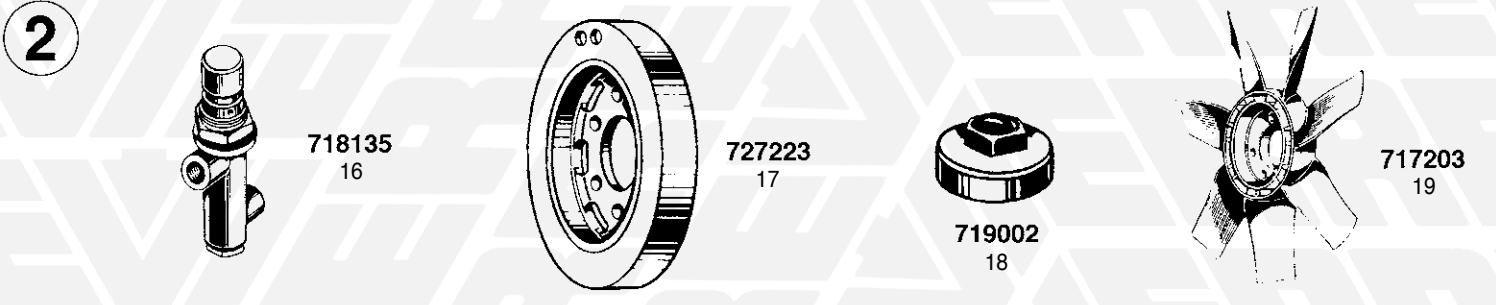
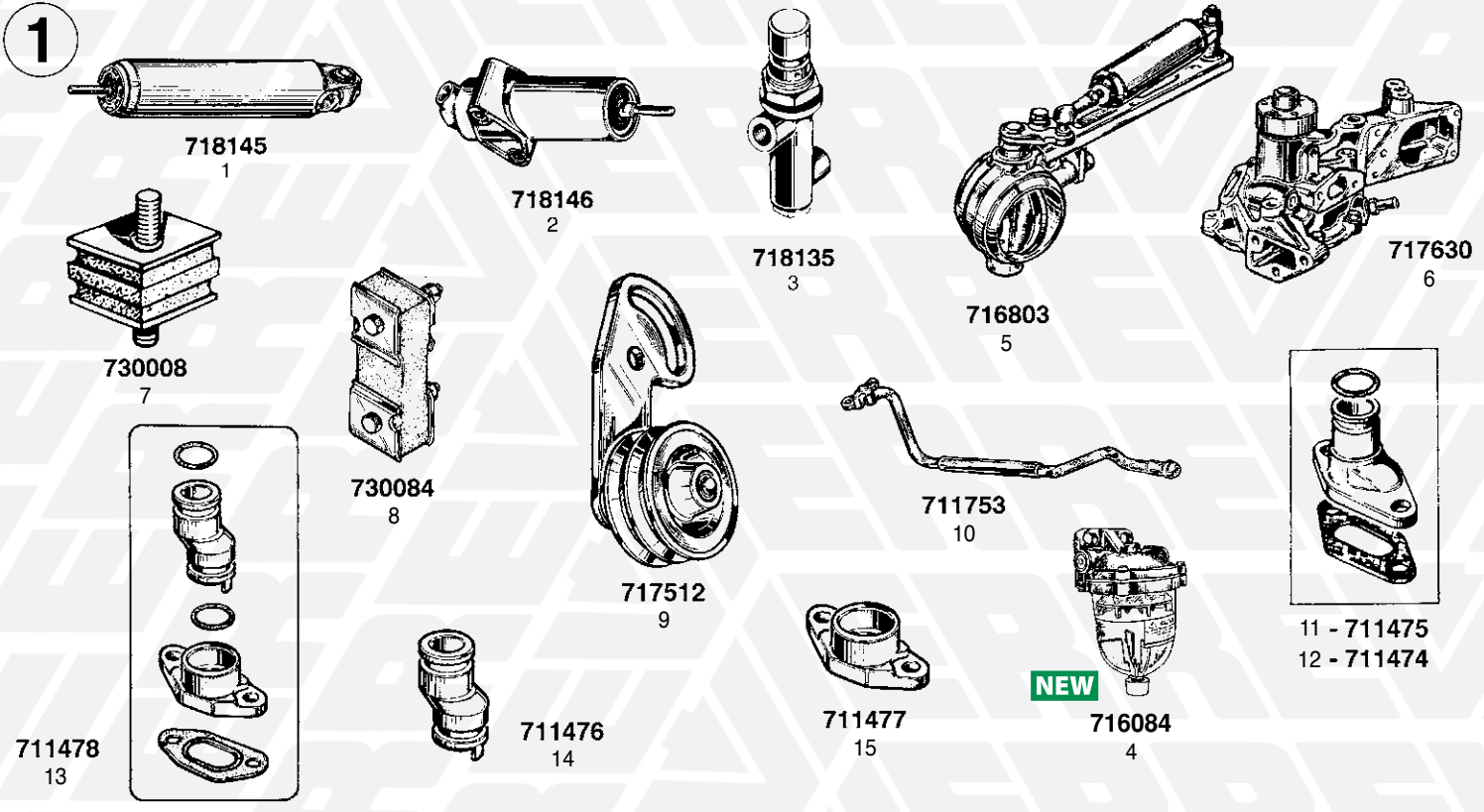
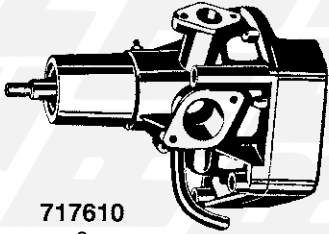

FIG. ITEM	RIF. ERREVI ERREVI REF.	DESCRIZIONE PARTICOLARI DESCRIPTION	TIPO VEHICLE MODEL	RIF. ORIG. ORIG. REF.
<b>1 115.14/ .17 - 135.14/ .17 - 145.17 - 175.17</b>				
1	<b>718145</b>	Cilindro operatore freno motore / <i>Exhaust brake cylinder</i>	115.17 - 135.17 - 145.17 - 175.17	42042638
2	<b>718146</b>	Cilindro arresto pompa iniezione / <i>Injection pump lock cylinder</i>		4717165
3	<b>718135</b>	Distrib. freno motore (MI) / <i>Exhaust brake distributor</i>		4782794 4604222
4	<b>716084</b>	Filtro combustibile / <i>Fuel filter</i>	115.14/.17 - 135.14/.17 145.17 - 175.14/.17	4686377 503475937
5	<b>716803</b>	Freno motore completo / <i>Exhaust brake assy</i>	115.17 - 135.17 - 145.17 - 175.17	4791129
6	<b>717630</b>	Pompa acqua completa / <i>Complete water pump</i> (adattabile a MOTORE 8040.25 - 8060.04/.24 - 8060.05.200 - 8060.25.600) (ENGINE TYPE 8040.25 - 8060.04/.24 - 8060.05.200 - 8060.25.600)	115.14/.17 - 135.14/.17 - 175.17	98497115 4835043
7	<b>730008</b>	Tassello sostegno ant. motore / <i>Engine mounting pad</i>		4617444
8	<b>730084</b>	Tassello sostegno tubo scarico compl. / <i>Exhaust strap assy</i>		-
9	<b>717512</b>	Tendicinghia completo / <i>Belt stretcher</i>	115.17 - 135.14 - 135.17 - 145.17	4803462
10	<b>711753</b>	Tubo acqua raffreddamento / <i>Water pipe cooler</i>		4762766
11	<b>711475</b>	Tubo completo colleg. pompa acqua al termostato / <i>Water pipe</i>	115.14/ .17 - 135.14/ .17	4772057
12	<b>711474</b>	Tubo completo colleg. pompa acqua al termostato U.T. / <i>Water pipe</i>		4774405
13	<b>711478</b>	<b>Kit attacco portatermostato composto da: / <i>Thermostat housing kit:</i></b>		-
14	<b>711476</b>	(1) Raccordo sup. per corpo termostato / <i>Union</i>		4859907
15	<b>711477</b>	(1) Flangia inf. per corpo termostato / <i>Connecting plate</i>		4859908
		(2) O.Ring		-
		(1) Guarnizione piana / <i>Flat washer</i>		-
<b>2 150.14 - 150/159NC17 - 150/159.17</b>				
16	<b>718135</b>	Distrib. freno motore (MI) / <i>Exhaust brake distributor</i>		4782794 4604222
17	<b>727223</b>	Smorzatore per albero motore / <i>Damper</i>		8823678
18	<b>719002</b>	Tappo serbatoio nafta / <i>Filler cap</i>		541257
19	<b>717203</b>	Ventilatore a 7 pale in nylon / <i>7-Blades plastic fan</i>	ø 70/500 150/159NC17	4698188
<b>3 150/159NC20 - 150.20 - 165.24 - 175.24</b>				
20	<b>718145</b>	Cilindro operatore freno motore / <i>Exhaust brake cylinder</i>	175.24	42042638
21	<b>718146</b>	Cilindro arresto pompa iniezione / <i>Injection pump lock cylinder</i>	175.24	4717165
22	<b>718135</b>	Distrib. freno motore (MI) / <i>Exhaust brake distributor</i>		4782794 4604222
23	<b>716530</b>	Freno motore / <i>Exhaust brake</i>	175.24	98418118
24	<b>719002</b>	Tappo serbatoio nafta / <i>Filler cap</i>		541257
25	<b>730030</b>	Tassello elastico per tubo scarico / <i>Exhaust pipe strap</i>	165.24	4643918
26	<b>729409</b>	Vite fissaggio collettore scarico / <i>Exhaust manifold bolt</i>	175.24	98490937 4742406
<b>4 645/650 - 650E - 655 - 662</b>				
27	<b>711498</b>	Corpo portatermostato / <i>Thermostat housing</i>	645/650N2 - N3 - 655 - 662N2	4626879
28	<b>718135</b>	Distrib. per freno motore (MI) / <i>Exhaust brake distributor</i>		4782794 4604222
29	<b>719002</b>	Tappo per serbatoio nafta / <i>Filler cap</i>		541257
30	<b>730008</b>	Tassello sostegno ant. motore / <i>Engine mounting pad</i>	645/650N2 - N3 - 655 - 662N2	4617444
31	<b>717513</b>	Tendicinghia completo / <i>Belt stretcher</i>		4616156
32	<b>712014</b>	Tirante completo accel. a mano / <i>Throttle control</i>		4667457 4645319
33	<b>711552</b>	Tubo flessibile scarico / <i>Exhaust flexible pipe</i>		4555085
34	<b>711471</b>	Tubo coll. pompa acqua al supporto portatermostato completo di guarnizione e anello / <i>Water pipe</i>		4673807
35	<b>717206</b>	Ventilatore a 9 pale / <i>9-Blades fan</i>	ø 28/410	4616572 8033778

1



726836  
1



717610  
2

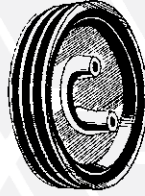

717522  
3

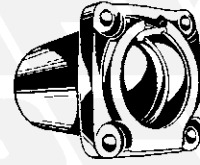

716037  
4



719002  
5



730017  
6



7 - 711544  
8 - 711547

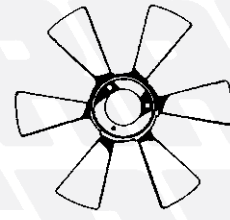

716508  
9

2



718134  
10



726837  
11

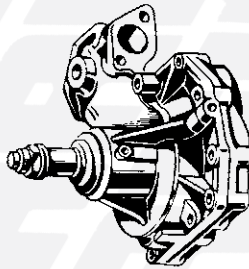

717620  
12

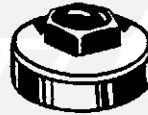

719002  
13

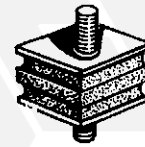

730008  
14



730030  
15

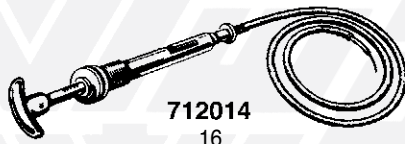

712014  
16



711544  
17

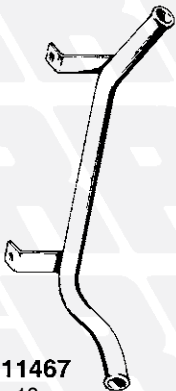

711467  
18



711468  
19



718135  
20

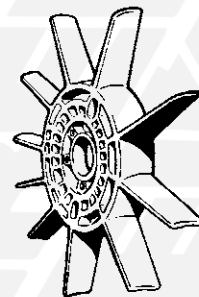

717201  
21

FIG. ITEM	RIF. ERREVI ERREVI REF.	DESCRIZIONE PARTICOLARI DESCRIPTION	TIPO VEHICLE MODEL	RIF. ORIG. ORIG. REF.
<b>1</b> <b>682N3 - 682N4</b> <b>(PARTICOLARI ADATTABILI AL MOTORE 203 A/61)</b> <b>(ENGINE TYPE 203 A/61)</b>				
1	<b>726836</b>	Dischetto per giunto pompa iniezione / <i>Shim</i>		4531680
2	<b>717610</b>	Pompa acqua completa / <i>Water pump assy</i>		4538058
3	<b>717522</b>	Puleggia condut. pompa servosterzo / <i>Power-steering pulley</i>		4777059 4515966
4	<b>716037</b>	Supp. per alberino com. pompa iniez. <i>Injection pump shaft housing</i>		741264
5	<b>719002</b>	Tappo per serbatoio nafta / <i>Filler cap</i>		340772
6	<b>730017</b>	Tass. sostegno ant. motore / <i>Engine front mounting pad</i>		4731592 844192
7	<b>711544</b>	Tubo flessibile scarico / <i>Exhaust flexible pipe</i>	682N2	881950
8	<b>711547</b>	Tubo flessibile scarico / <i>Exhaust flexible pipe</i>		4514684
9	<b>716508</b>	Ventilatore a 6 pale in alluminio / <i>6-Blades fan</i>		-
<b>2</b> <b>684N/NP - 160NC/NT</b> <b>(PARTICOLARI ADATTABILI AL MOTORE 8200.02/.03)</b> <b>(ENGINE TYPE 8200.02/.03)</b>				
10	<b>718134</b>	Cilindro operat. com. freno motore / <i>Exhaust brake cylinder</i>		4695111 4671869
11	<b>726837</b>	Dischetto per giunto pompa iniezione / <i>Shim</i>		4538013
12	<b>717620</b>	Pompa acqua completa 1ª Serie / <i>Water pump assy</i>	684N/NP	4606023
13	<b>719002</b>	Tappo per serbatoio nafta / <i>Filler cap</i>		541257
14	<b>730008</b>	Tassello sostegno ant. motore / <i>Engine mounting pad</i>		4617444
15	<b>730030</b>	Tassello elastico sostegno tubo scarico / <i>Exhaust pipe pad</i>		4643918
16	<b>712014</b>	Tirante completo acceleratore / <i>Throttle control</i>		4639253
17	<b>711544</b>	Tubo flessibile scarico / <i>Exhaust flexible pipe</i>		881950
18	<b>711467</b>	Tubo entrata acqua radiatore / <i>Radiator pipe, inlet</i>		4671034
19	<b>711468</b>	Tubo uscita acqua radiatore / <i>Radiator pipe, outlet</i>		4631107
20	<b>718135</b>	Valvola distributore freno motore (MI) / <i>Distributor valve</i>		4782794 4604222
21	<b>717201</b>	Ventilatore a 10 pale in nylon / <i>10-Blades plastic fan</i>	ø 85/560	4629725

**MOTORE  
ENGINE**

1



718134

1



726837

2



718135

3

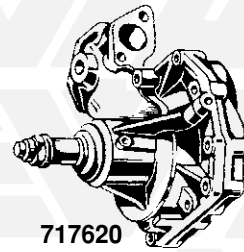

717620

4

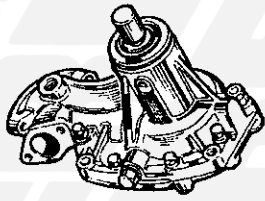

717634

5



719002

6



730030

7

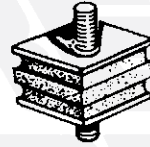

730008

8

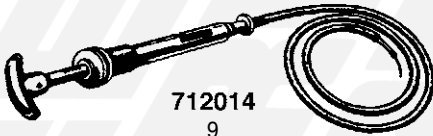

712014

9



711550

10



711556

11

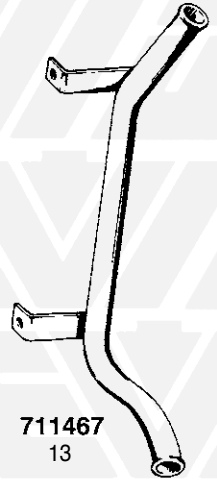

711467

13



711468

14

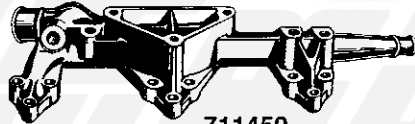

711450

15

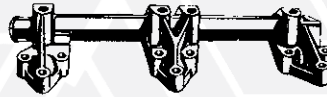

711451

16



711755

12

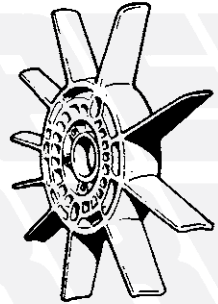

717201

20



711452

17



711453

18



711454

19

2

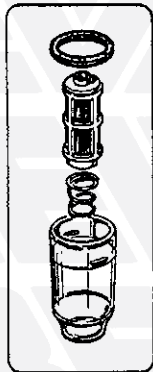

732605

21

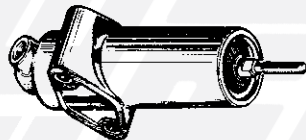

718146

22



718144

23



718135

24

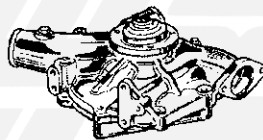

717631

27

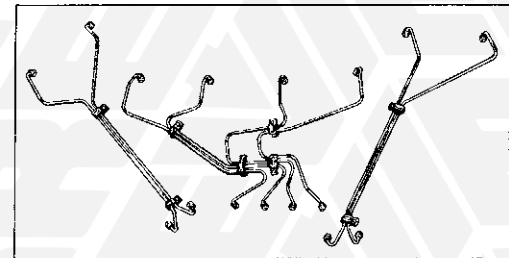

732210

28

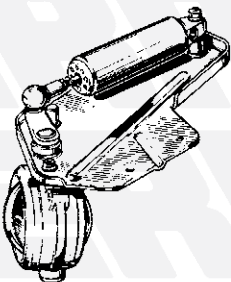

716542 D/RH

25

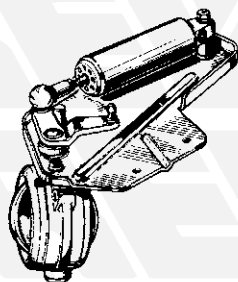

716543 S/LH

26



730030

29



729409

30

FIG. ITEM	RIF. ERREVI ERREVI REF.	DESCRIZIONE PARTICOLARI DESCRIPTION	TIPO VEHICLE MODEL	RIF. ORIG. ORIG. REF.
<b>1</b> <b>619N1 - 300PC - 160.26 - 170/190 NC26/F26 - 180.26 - 190.i26</b> <b>(PARTICOLARI ADATTABILI AL MOTORE 8210.02/ .03)</b> <b>(ENGINE TYPE 8210.02/ .03)</b>				
1	<b>718134</b>	Cilindro operatore freno motore / <i>Exhaust brake cylinder</i>		4695111 4671869
2	<b>726837</b>	Dischetto per giunto pompa iniezione / <i>Shim</i>		4538013
3	<b>718135</b>	Distributore freno motore tipo (MI) / <i>Distributor valve</i>		4782794 4604222
4	<b>717620</b>	Pompa acqua completa / <i>Water pump assy</i>	619 - 300	4606023
5	<b>717634</b>	Pompa acqua completa / <i>Complete water pump</i> (adattabile a MOTORE 8210 SR 110 / 125 - 8200.03 - 8210.02) (ENGINE TYPE 8210 SR 110 / 125 - 8200.03 - 8210.02)	160.26 - 170/190 NC26 180.26 - 190.i26	4710552 4692698
6	<b>719002</b>	Tappo per serbatoio nafta / <i>Filler cap</i>		541257
7	<b>730030</b>	Tassello elastico sostegno tubo scarico / <i>Exhaust pipe pad</i>		4643918
8	<b>730008</b>	Tassello sostegno ant. motore / <i>Engine mounting pad</i>		4617444
9	<b>712014</b>	Tirante acceleratore completo / <i>Throttle control</i>		4639253
10	<b>711550</b>	Tubo flessibile scarico / <i>Exhaust flexible pipe</i>	619 - 300	4631757
11	<b>711556</b>	Tubo flessibile scarico con fascetta U.T. / <i>Flexible pipe c/w clamp</i>	619 - 300	4776196
12	<b>711755</b>	Tubo acqua / <i>Water pipe</i>	619 - 300	4684410
13	<b>711467</b>	Tubo entrata acqua radiatore / <i>Radiator pipe, inlet</i>	619 - 300	4671034
14	<b>711468</b>	Tubo uscita acqua radiatore / <i>Radiator pipe, outlet</i>	619 - 300	4631107
15	<b>711450</b>	Tubo ant. acqua lato D. / <i>Water pipe, RH side</i>		4670076 4670075
16	<b>711451</b>	Tubo post. acqua lato D. / <i>Water pipe, RH side</i>		4640055
17	<b>711452</b>	Tubo inf. acqua lato D. / <i>Water pipe, RH side</i>		98471454 4640056
18	<b>711453</b>	Tubo ant. acqua lato S. / <i>Water pipe, LH side</i>		4628336
19	<b>711454</b>	Tubo post. acqua lato S. / <i>Water pipe, LH side</i>		4616590
20	<b>717201</b>	Ventilatore a 10 pale in nylon / <i>10-Blades plastic fan</i>	619 - 300	4629725
<b>2</b> <b>170/190NC33 - 170NC35 - 170/190F35 - 190.i35 - 330F35/ .35 - 220.35T</b> <b>(PARTICOLARI ADATTABILI AL MOTORE 8210.01-.02)</b> <b>(ENGINE TYPE 8210.01-.02)</b>				
21	<b>732605</b>	Kit filtro pompa aliment. tipo BOSCH / <i>Feed pump filter kit (BOSCH type)</i>	170/190NC33 - 170NC35	-
22	<b>718146</b>	Cilindro arresto pompa iniezione / <i>Injection pump lock cylinder</i>	190.i35 - 330F35/ .35 - 220.35T	4717165
23	<b>718144</b>	Cilindretto comando freno motore / <i>Exhaust brake cylinder</i>	190.i35 - 330.35 - 220.35T	7981576
24	<b>718135</b>	Distributore freno motore tipo MI / <i>Distributor valve</i>	<b>NO 330</b>	4782794 4604222
25	<b>716542</b>	Freno motore completo D. / <i>Exhaust brake assy RH</i>	190.i35 - 330.35 - 220.35T	4758498
26	<b>716543</b>	Freno motore completo S. / <i>Exhaust brake assy LH</i>	190.i35 - 330.35 - 220.35T	4758497
27	<b>717631</b>	Pompa acqua completa / <i>Complete water pump</i> (adattabile a MOTORE 8280.02.109/121/269 - 8280.22 - 8280.22.007/033) (ENGINE TYPE 8280.02.109/121/269 - 8280.22 - 8280.22.007/033)	170.33/.35	4764156 4737154
28	<b>732210</b>	Serie tubi iniettori U.T. / <i>Injector pipe set</i>	190.i35 - 330.35	4746793 4807620
29	<b>730030</b>	Tassello elastico sostegno tubo scarico / <i>Exhaust pipe pad</i>	<b>NO 330</b>	4643918
30	<b>729409</b>	Vite fissaggio collettore scarico U.T. / <i>Manifold bolt</i>		98490937 4742406

**MOTORE  
ENGINE**

1



718147  
1



718145  
2



718146  
3



726837  
4



718135  
5

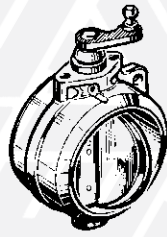

716546  
6

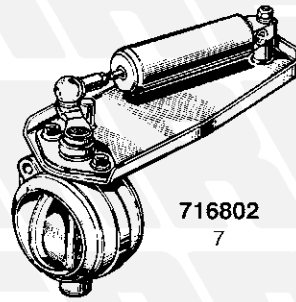

716802  
7

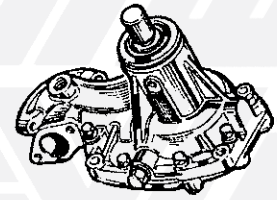

717634  
8

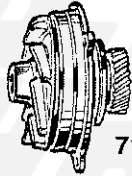

717652  
9



730008  
10



730030  
11

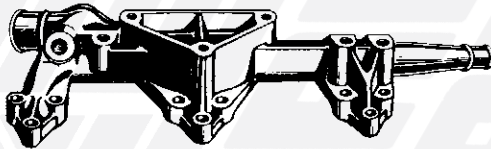

711450  
12

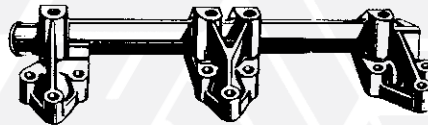

711451  
13



711452  
14

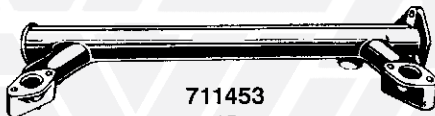

711453  
15

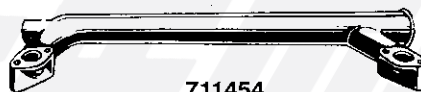

711454  
16



711675  
17



729409  
18

2



718147  
19

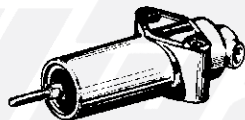

718146  
20



726837  
21

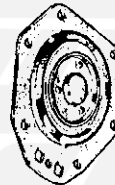

731725  
23

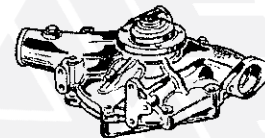

717631  
24

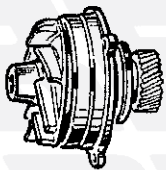

717636  
26

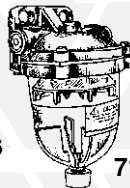

**NEW**  
716084  
22

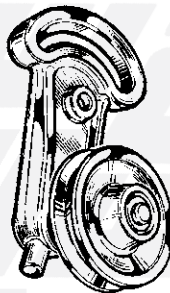

717511  
29

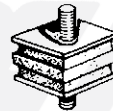

730008  
30



711452  
31

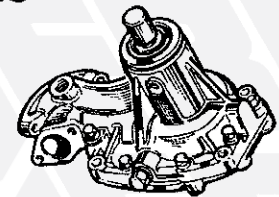

717634  
25

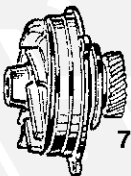

717652  
27

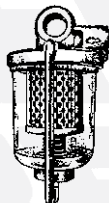

**NEW**  
716085  
28

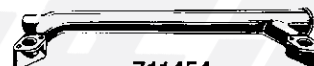

711454  
32



729409  
33

3

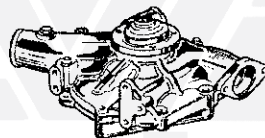

717631  
34



FIG. ITEM	RIF. ERREVI ERREVI REF.	DESCRIZIONE PARTICOLARI DESCRIPTION	TIPO VEHICLE MODEL	RIF. ORIG. ORIG. REF.
<div style="text-align: center;"> <span style="font-size: 2em; border: 1px solid black; border-radius: 50%; padding: 5px;">1</span> <b>190.30 - 240.30 - 330.30</b>  <b>(PARTICOLARI ADATTABILI AL MOTORE 8210.22) / (ENGINE TYPE 8210.22)</b> </div>				
1	<b>718147</b>	Cilindretto comando freno motore / <i>Exhaust brake cylinder</i>	1ª Serie	4700966
2	<b>718145</b>	Cilindretto comando freno motore / <i>Exhaust brake cylinder</i>	U.T.	42126564
3	<b>718146</b>	Cilindro arresto pompa iniezione / <i>Injection pump lock cylinder</i>		4717165
4	<b>726837</b>	Dischetto per giunto pompa iniezione / <i>Shim</i>		4538013
5	<b>718135</b>	Distributore freno motore tipo MI / <i>Distributor valve</i>	190.30 - 240.30	4782794 4604222
6	<b>716546</b>	Freno motore / <i>Exhaust brake</i>	190.30 - 330.30	42124922
7	<b>716802</b>	Freno motore completo / <i>Exhaust brake assy</i>	190.30 - 330.30	42124998
8	<b>717634</b>	Pompa acqua completa / <i>Complete water pump</i> (adattabile a MOTORE / <i>ENGINE TYPE</i> 8210 SR 110 / 125 - 8200.03 - 8210.02)	190.30-240.30/.33	4710552 4692698
9	<b>717652</b>	Semipompa per pompa acqua / <i>Water semipump</i>	Z = 24	42530032 93190286
10	<b>730008</b>	Tassello sostegno ant. motore / <i>Engine mounting pad, front</i>	190.30 - 240.30	4617444
11	<b>730030</b>	Tassello elastico sostegno tubo scarico / <i>Exhaust pipe pad</i>	190.30 - 240.30	4643918
12	<b>711450</b>	Tubo ant. acqua lato D. / <i>Water pipe, RH side</i>		4670076 4670075
13	<b>711451</b>	Tubo post. acqua lato D. / <i>Water pipe, RH side</i>		4640055
14	<b>711452</b>	Tubo inf. acqua lato D. / <i>Water pipe, RH side</i>		98471454 4640056
15	<b>711453</b>	Tubo ant. acqua lato S. / <i>Water pipe, LH side</i>		4628336
16	<b>711454</b>	Tubo post. acqua lato S. / <i>Water pipe, LH side</i>		4616590
17	<b>711675</b>	Tubo flessibile scarico / <i>Exhaust flexible pipe</i>	L = 353 ø est. mm 105	330.30 42090050
18	<b>729409</b>	Vite fissaggio collettore scarico U.T. / <i>Manifold bolt</i>	190.30 - 240.30	98490937 4742406
<div style="text-align: center;"> <span style="font-size: 2em; border: 1px solid black; border-radius: 50%; padding: 5px;">2</span> <b>190.33 - 190.36 - 240.36 TURBOSTAR - 190.30 TURBOTECH</b>  <b>(PARTICOLARI ADATTABILI AL MOTORE 8210.22-42) / (ENGINE TYPE 8210.22-42)</b> </div>				
19	<b>718147</b>	Cilindretto comando freno motore / <i>Exhaust brake cylinder</i>		4700966
20	<b>718146</b>	Cilindro arresto pompa iniezione / <i>Injection pump lock cylinder</i>		4717165
21	<b>726837</b>	Dischetto per giunto pompa iniezione / <i>Shim</i>		4538013
22	<b>716084</b>	Filtro combustibile / <i>Fuel filter</i>	TURBOTECH - TURBOSTAR	4686377 503475937
23	<b>731725</b>	Membrana sfiato olio motore / <i>Breather diaphragm</i>	190.36 - 240.36	4771078
24	<b>717631</b>	Pompa acqua completa / <i>Complete water pump</i> (adattabile a MOTORE / <i>ENGINE TYPE</i> 8280.02.109/121/269 - 8280.22 - 8280.22.007/033)	190.33/.35	4764156 4737154
25	<b>717634</b>	Pompa acqua completa / <i>Complete water pump</i> (adattabile a MOTORE / <i>ENGINE TYPE</i> 8210 SR 110 / 125 - 8200.03 - 8210.02)	190.33	4710552 4692698
26	<b>717636</b>	Semipompa per pompa acqua / <i>Water semipump</i> (adattabile a MOTORE / <i>ENGINE TYPE</i> 8210.42 ECONOMY)	Z = 19	TURBOSTAR - TURBOTECH 42530033 93190287
27	<b>717652</b>	Semipompa per pompa acqua / <i>Water semipump</i>	Z = 24	TURBOSTAR TURBOTECH 42530032 93190286
28	<b>716085</b>	Supporto filtro combustibile / <i>Fuel filter bracket</i>	TURBOSTAR TURBOTECH	4776380 4797318 4797320 4822227 4822228
29	<b>717511</b>	Supporto tendicinghia completo / <i>Belt stretcher bracket</i>	190.36 - 240.36	4831072
30	<b>730008</b>	Tassello sostegno ant. motore / <i>Engine mounting pad, front</i>		4617444
31	<b>711452</b>	Tubo inf. acqua lato D. / <i>Water pipe, RH side</i>		98471454 4640056
32	<b>711454</b>	Tubo post. acqua lato S. / <i>Water pipe, LH side</i>		4616590
33	<b>729409</b>	Vite fissaggio collettore scarico U.T. / <i>Manifold bolt</i>		98490937 4742406
<div style="text-align: center;"> <span style="font-size: 2em; border: 1px solid black; border-radius: 50%; padding: 5px;">3</span> <b>260PC35 - 330.35</b> </div>				
34	<b>717631</b>	Pompa acqua completa / <i>Complete water pump</i> (adattabile a MOTORE / <i>ENGINE TYPE</i> 8280.02.109/ 121/269 - 8280.22 - 8280.22.007/033)		4764156 4737154

1



718146

1



726837

2

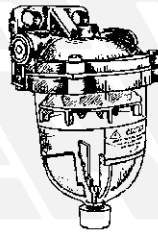

716084

3

NEW



716085

4

NEW

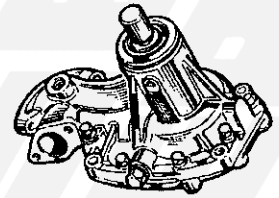

717634

5

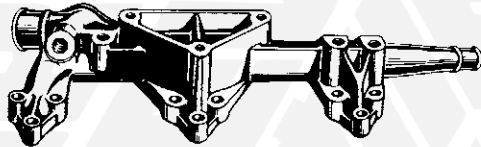

711450

6

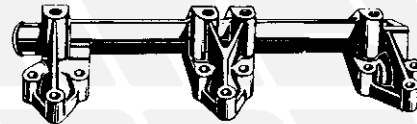

711451

7



711452

8

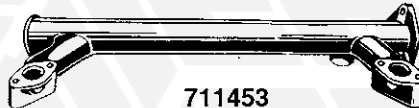

711453

9

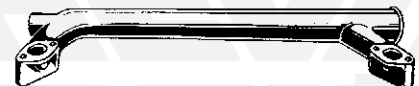

711454

10

2



718145

11

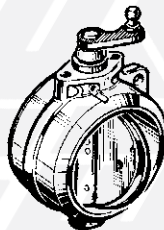

716546

12

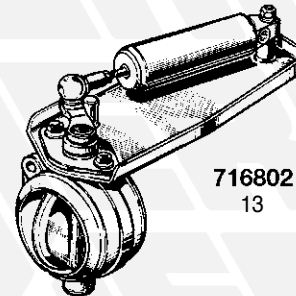

716802

13



731725

14



717652

15

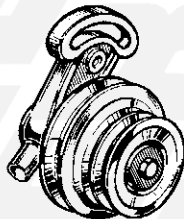

717510

16



711675

17

3



718144 - 718145

18

19



718146

20



718135

21

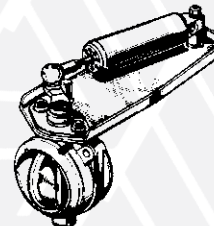

716544

22

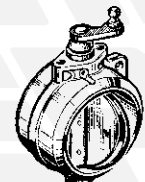

716546

23

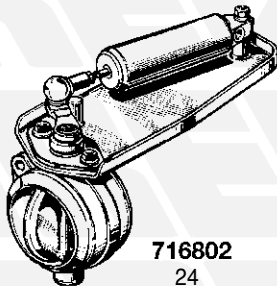

716802

24

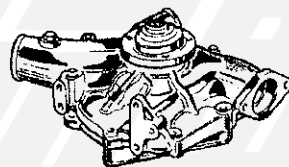

717631

25

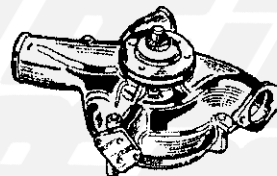

717632

26



731725

27

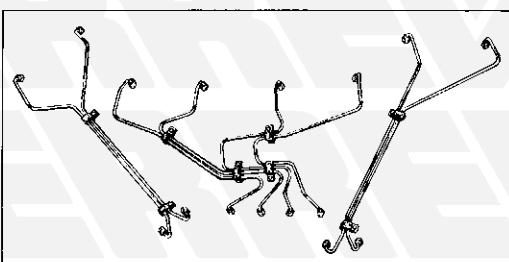

732210

28



730030

29

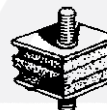

730923

30



729409

31

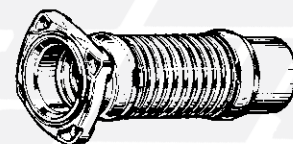

711674 (L=mm 290 - ø est. tubo 105 mm)

32

FIG. ITEM	RIF. ERREVI ERREVI REF.	DESCRIZIONE PARTICOLARI DESCRIPTION	TIPO VEHICLE MODEL	RIF. ORIG. ORIG. REF.
<b>1</b> <b>330F26 - 330.26</b> <b>(PARTICOLARI ADATTABILI AL MOTORE 8210.02 v. 269/731) / (ENGINE TYPE 8210.02 v. 269/731)</b>				
1	<b>718146</b>	Cilindro arresto pompa / <i>Injection pump lock cylinder</i>		4717165
2	<b>726837</b>	Dischetto per giunto pompa iniezione / <i>Shim</i>		4538013
3	<b>716084</b>	Filtro combustibile / <i>Fuel filter</i>	330.26H - 330.30H	4686377 503475937
4	<b>716085</b>	Supporto filtro combustibile / <i>Fuel filter bracket</i>	330	4776380 4797318 4797320 4822227 4822228
5	<b>717634</b>	Pompa acqua completa / <i>Complete water pump</i> (adattabile a MOTORE / <i>ENGINE TYPE</i> 8210 SR 110 / 125 - 8200.03 - 8210.02)	330.26	4710552 4692698
6	<b>711450</b>	Tubo ant. acqua lato D. / <i>Water pipe, RH side</i>		4670076 4670075
7	<b>711451</b>	Tubo post. acqua lato D. / <i>Water pipe, RH side</i>		4640055
8	<b>711452</b>	Tubo inf. acqua lato D. / <i>Water pipe, RH side</i>		98471454 4640056
9	<b>711453</b>	Tubo ant. acqua lato S. / <i>Water pipe, LH side</i>		4628336
10	<b>711454</b>	Tubo post. acqua lato S. / <i>Water pipe, LH side</i>		4616590
<b>2</b> <b>330.36</b> <b>(PARTICOLARI ADATTABILI AL MOTORE 8210.42.269) / (ENGINE TYPE 8210.42.269)</b>				
11	<b>718145</b>	Cilindretto comando freno motore / <i>Exhaust brake cylinder</i>		42126564
12	<b>716546</b>	Freno motore / <i>Exhaust brake</i>		42124922
13	<b>716802</b>	Freno motore completo / <i>Exhaust brake</i>		42124998 42086121
14	<b>731725</b>	Membrana sfiato olio motore / <i>Breather diaphragm</i>		4771078
15	<b>717652</b>	Semipompa per pompa acqua / <i>Water semipump</i>	Z = 24 330.36H	42530032 93190286
16	<b>717510</b>	Supporto completo tendicinghia / <i>Belt stretcher bracket</i>		98480740
17	<b>711675</b>	Tubo flessibile scarico / <i>Exhaust flexible pipe</i>		42090050
<b>3</b> <b>190.38 - 190.42 - 190.48 - 220.38 - 240.38</b> <b>(PARTICOLARI ADATTABILI AL MOTORE 8280.22-42) / (ENGINE TYPE 8280.22.42)</b>				
18	<b>718144</b>	Cilindretto comando freno motore / <i>Exhaust brake cylinder</i>	190.48	41022032 8194594
19	<b>718145</b>	Cilindretto comando freno motore / <i>Exhaust brake cylinder</i>		41022031 42050524
20	<b>718146</b>	Cilindro arresto pompa iniezione / <i>Injection pump lock cylinder</i>	220.38 - 240.38	4717165
21	<b>718135</b>	Distributore per freno motore tipo MI / <i>Distributor valve</i>	190.38 - 220.38 - 240.38	4782794 4604222
22	<b>716544</b>	Freno motore completo / <i>Exhaust brake assy</i>	190.38 - 220.38 - 240.38	42051740
23	<b>716546</b>	Freno motore / <i>Exhaust brake assy</i>	190.48	42124922
24	<b>716802</b>	Freno motore completo U.T. / <i>Exhaust brake assy</i>	190.48	42124998 42086121
25	<b>717631</b>	Pompa acqua completa / <i>Complete water pump</i> (adattabile a MOTORE / <i>ENGINE TYPE</i> 8280.02.109/ 121/269 - 8280.22 - 8280.22.007/033)	190.38/.42 - 220.38 - 240.38	4764156 4737154
26	<b>717632</b>	Pompa acqua completa / <i>Complete water pump</i> (adattabile a MOTORE / <i>ENGINE TYPE</i> 8280.42S)	190.48 - 220.48 - 240.48 - 260.48	500300470 4812406
27	<b>731725</b>	Membrana sfiato olio motore / <i>Breather diaphragm</i>	190.38/ .42/ .48	4771078
28	<b>732210</b>	Serie tubi iniettori U.T. / <i>Injector pipe set</i>	190.38/ .42 - 220.38 - 240.38	4746793
29	<b>730030</b>	Tass. elastico sostegno tubo scarico / <i>Exhaust pipe pad</i>	190.38 - 220.38 - 240.38	4643918
30	<b>730923</b>	Tassello sostegno motore / <i>Engine mounting pad</i>	TURBOSTAR 190.42/.48 - 240.48 - 260.48	4677249 503475739
31	<b>729409</b>	Vite fissaggio collettore scarico / <i>Manifold bolt</i>		98490937 4742406
32	<b>711674</b>	Tubo flessibile scarico / <i>Exhaust flexible pipe</i>	L = mm 290 ø est. tubo mm 105 190.48	42092241

1

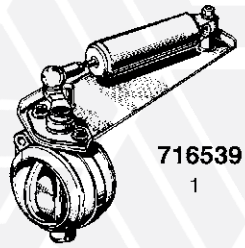

716539  
1



718145  
2

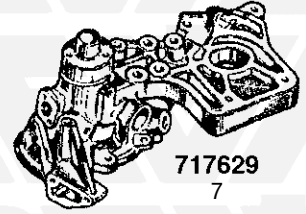

717629  
7

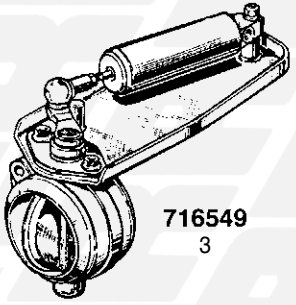

716549  
3

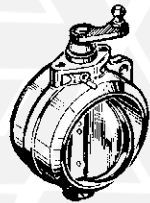

716548  
4



718145  
5

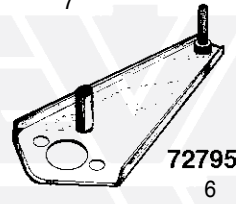

727950  
6

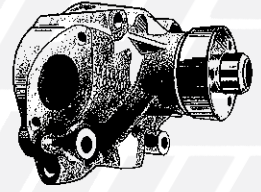

717671  
8

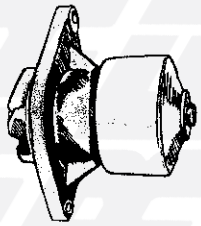

717664  
9

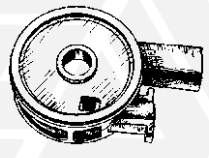

10-716086  
**NEW**

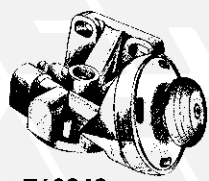

716040  
11



730394  
12

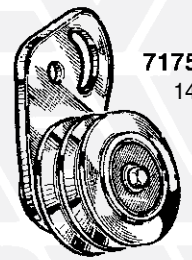

717528  
14



730895  
13  
**NEW**



17-733178  
**NEW**

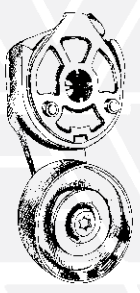

717529  
15

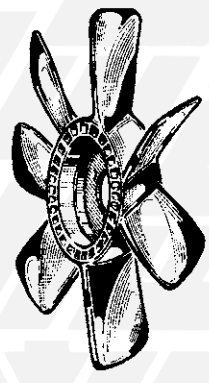

717209  
16

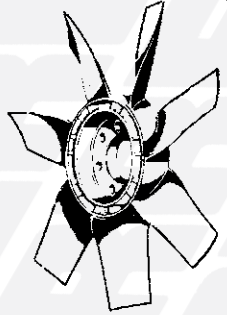

18-717219  
19-717211

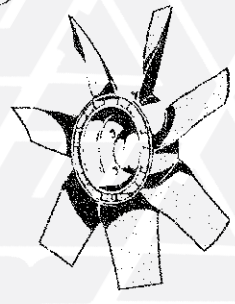

717233  
20

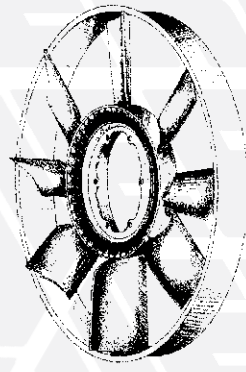

717221  
21

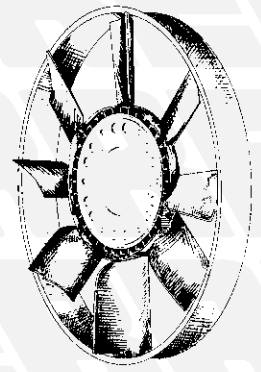

**NEW** 717240  
22

2

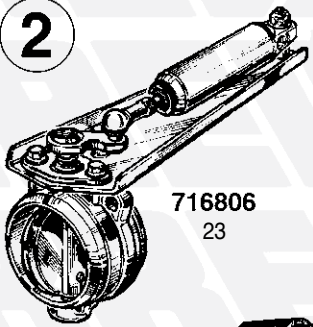

716806  
23

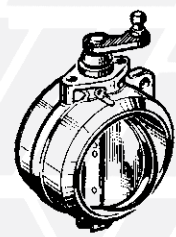

716805  
24



718145  
25

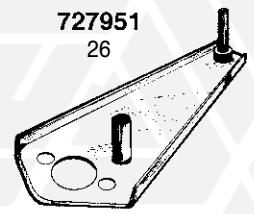

727951  
26

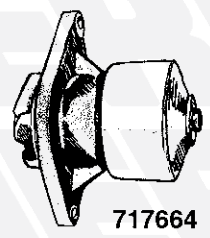

717664  
27

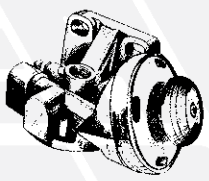

716040  
28

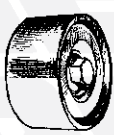

717535  
29

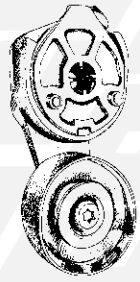

717529  
31

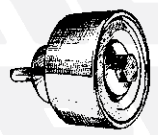

717536  
30

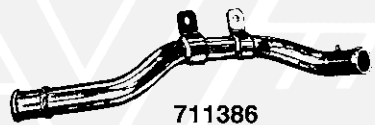

711386  
32

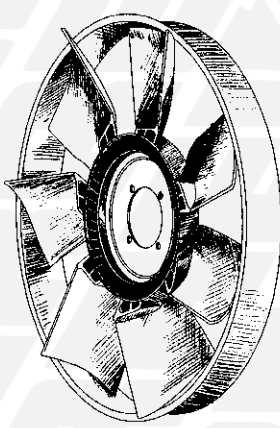

717220  
33

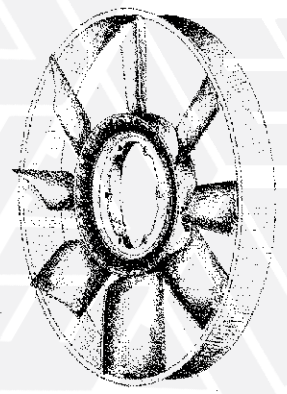

717234  
34

FIG. ITEM	RIF. ERREVI ERREVI REF.	DESCRIZIONE PARTICOLARI DESCRIPTION	TIPO VEHICLE MODEL	RIF. ORIG. ORIG. REF.
<b>1 EUROCARGO</b>				
1	<b>716539</b>	Freno motore completo / <i>Exhaust brake assy</i>	60E10/E12/E14 - 65E10/E12/E14 75E12/E14	98439693
2	<b>718145</b>	Cilindretto comando freno motore / <i>Exhaust brake cylinder</i>	60E10/E12/E14-65E10/E12/E14 75E12/E14	42042638
3	<b>716549</b>	Freno motore completo / <i>Exhaust brake assy</i>	<b>NO</b> 60E10/E12/E14-65E10/E12/E14 <b>NO</b> 75E12/E14	500322095 98421122
4	<b>716548</b>	Freno motore / <i>Exhaust brake</i>	<b>NO</b> 60E10/E12/E14-65E10/E12/E14 <b>NO</b> 75E12/E14	42532610 93159509
5	<b>718145</b>	Cilindretto comando freno motore / <i>Exhaust brake cylinder</i>	<b>NO</b> 60E10/E12/E14-65E10/E12/E14 <b>NO</b> 75E12/E14	41022031 42042638
6	<b>727950</b>	Staffa per cilindro freno motore / <i>Exhaust brake bracket</i>		93191098
7	<b>717629</b>	Pompa acqua completa / <i>Complete water pump</i> (adattabile a Motore 8040.25/.45 - 8060.25/.45) ( <i>Engine type 8040.25/.45 - 8060.25/.45</i> )	60E14-65E12/E14-75E12/E14/E15 80E15/E18/E21-100E15/E18/E21 120E15/E18-130E15/E18/E21	98415831
8	<b>717671</b>	Pompa acqua completa (adattabile a motore 8060.45 a 6 Cilindri) <i>Water pump assy (Engine type 8060.45 Six Cylinders)</i>	120E23 - 130E23 - 150E23 280E23	4838676
9	<b>717664</b>	Pompa acqua completa / <i>Water pump assy</i>		504062854 4891252
10	<b>716086</b>	Riscaldatore filtro combustibile / <i>Heater fuel filter</i>	EUROCARGO	42548584 99483892
11	<b>716040</b>	Supporto filtro combustibile / <i>Fuel filter bracket</i>		500316868
12	<b>730394</b>	Supporto posteriore motore / <i>Rear engine stretcher</i>	60E10/E12/E14 65E10/E12/E12H/E14 - 75E12/E14 80E15/E18 - 100E18	98411547 97179140 61269244
13	<b>730895</b>	Supporto motore / <i>Engine bracket</i>		-
14	<b>717528</b>	Tendicinghia completo / <i>Belt stretcher</i> ( <b>puleggia nuda 98436012-braccio tendicinghia 98429672</b> ) ( <b>Stretcher bracket Ref. 98429672 - Stretcher pulley Ref. 98436012</b> )		
15	<b>717529</b>	Tendicinghia completo / <i>Belt stretcher</i>		504315785 504065874 4891116
16	<b>717209</b>	Ventilatore a 7 pale / <i>7-Blades fan</i>	ø 80/530	98468151
17	<b>733178</b>	Tubo aria compressore / <i>Exhaust elbow</i>	EUROCARGO	4649176
18	<b>717219</b>	Ventilatore a 7 pale / <i>7-Blades fan</i>	ø 80/420	60E11 - 65E10 4800473
19	<b>717211</b>	Ventilatore a 7 pale / <i>7-Blades fan</i>	ø 80/470	60E10/E12 - 65E10/E12 - 75E12 4800475 4782877
20	<b>717233</b>	Ventilatore a 7 pale / <i>7-Blades fan</i>	ø 82/466	60E12 - 65E12/E14 - 75E12/E14/E15 80E15 - 100E15/E21 - 120E15 130E15 - 150E15 - 170E15 98468663
21	<b>717221</b>	Ventilatore a 8 pale / <i>8-Blades fan</i>	ø 180/705	75E12 99450016
22	<b>717240</b>	Ventilatore a 8 pale / <i>8-Blades fan</i>	ø 180/705	EUROFIRE TECTOR - E.CARGO TECTOR 504029737
<b>2 EUROCARGO "TECTOR"</b>				
23	<b>716806</b>	Freno motore completo / <i>Exhaust brake assy</i>		500364392
24	<b>716805</b>	Freno motore / <i>Exhaust brake</i>		42536146
25	<b>718145</b>	Cilindretto comando freno motore / <i>Exhaust brake cylinder</i>		41022031
26	<b>727951</b>	Staffa per cilindro freno motore / <i>Exhaust brake bracket</i>		42550425
27	<b>717664</b>	Pompa acqua completa / <i>Water pump assy</i>		504062854 4891252
28	<b>716040</b>	Supporto filtro combustibile / <i>Fuel filter bracket</i>		500316868
29	<b>717535</b>	Rullo tendicinghia / <i>Belt Stretcher roller</i>		504065878 4897031
30	<b>717536</b>	Rullo tendicinghia / <i>Belt Stretcher roller</i>		504065877 4892356
31	<b>717529</b>	Tendicinghia completo / <i>Belt stretcher</i>		504315785 504065874 4891116
32	<b>711386</b>	Tubo acqua raffreddamento / <i>Water pipe cooler</i>		504087354
33	<b>717220</b>	Ventilatore a 7 pale / <i>7-Blades fan</i>	ø 82,5/550	500353523
34	<b>717234</b>	Ventilatore a 8 pale / <i>8-Blades fan</i>	ø 180/650	504069656

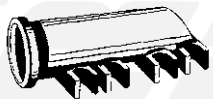

733176  
1

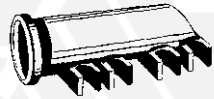

733172  
2



733175  
3



733171  
4

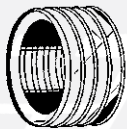

733177  
5



733173  
6



733174  
7



718135  
8

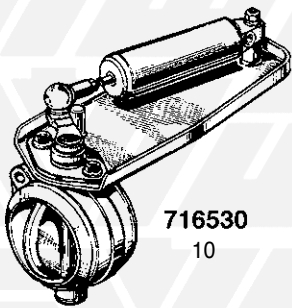

716530  
10

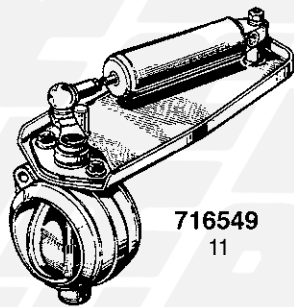

716549  
11

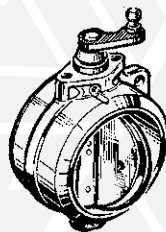

716548  
12

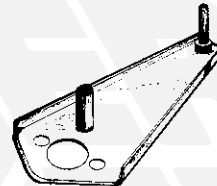

727950  
13



718145  
14

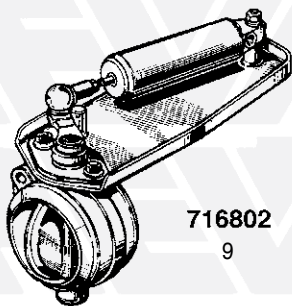

716802  
9

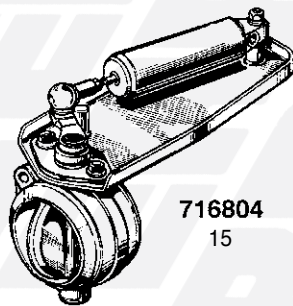

716804  
15

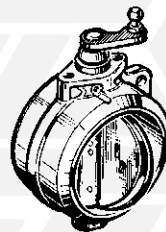

716546  
16



718144  
17

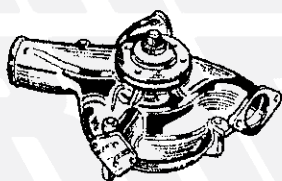

717632  
18

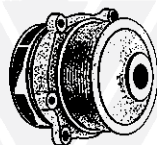

717670  
19

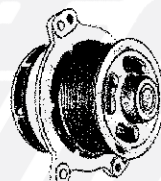

717663  
20

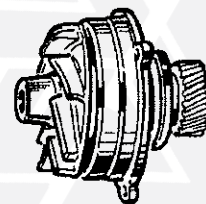

21 - 717635 Z=23  
22 - 717636 Z=19

FIG. ITEM	RIF. ERREVI ERREVI REF.	DESCRIZIONE PARTICOLARI DESCRIPTION	TIPO VEHICLE MODEL	RIF. ORIG. ORIG. REF.
<b>260.32 TURBOTECH EUROTECH - EUROSTAR - EUROTRAKKER EUROTECH "Cursor" EUROSTAR "Cursor" EUROTRAKKER "Cursor" STRALIS</b>				
1	<b>733176</b>	Collettore scarico anteriore / posteriore / <i>Exhaust manifold</i>	EUROTECH "Cursor" EUROSTAR "Cursor" - STRALIS	99434992 504027315
2	<b>733172</b>	Collettore scarico anteriore e posteriore / <i>Exhaust manifold</i>	EUROTECH "Cursor" - EUROSTAR "Cursor" - EUROTRAKKER "Cursor" TRAKKER - STRALIS	99443710 504030852
3	<b>733175</b>	Collettore scarico centrale / <i>Exhaust manifold</i>	EUROTECH "Cursor" EUROSTAR "Cursor" - STRALIS	500335873 504026369
4	<b>733171</b>	Collettore scarico centrale / <i>Exhaust manifold</i>	EUROTRAKKER "Cursor" TRAKKER	500390940 504046507
5	<b>733177</b>	Manicotto di collegamento scarico / <i>Connector sleeve</i>	EUROCARGO "Tector" EUROTECH "Cursor" EUROSTAR "Cursor" STRALIS	99440117 500333842 4896650 4896651
6	<b>733173</b>	Manicotto di collegamento scarico / <i>Connector sleeve</i>	EUROTRAKKER "Cursor" TRAKKER - STRALIS	99443769
7	<b>733174</b>	Manicotto di collegamento scarico / <i>Connector sleeve</i>	ø 54x57x40 EUROTRAKKER "Cursor" TRAKKER - STRALIS	99443770
8	<b>718135</b>	Distributore per freno motore tipo MI / <i>Distributor valve</i>	260.32 TURBOTECH	4782794
9	<b>716802</b>	Freno motore completo / <i>Exhaust brake assy</i>	260.32 TURBOTECH EUROTECH { 180E42 - 190E42 240E42 - 260E42 400E42 - 440E42 EUROSTAR-EUROTRAKKER	42558789 42086121
10	<b>716530</b>	Freno motore completo / <i>Exhaust brake assy</i>	EUROTECH { 180E30/E34 - 190E30 400E30/E34	98418118
11	<b>716549</b>	Freno motore completo / <i>Exhaust brake assy</i>	EUROTECH { 180E24/E27 190E24/E27 - 325E27	500322095 98421122
12	<b>716548</b>	Freno motore / <i>Exhaust brake</i>	EUROTECH { 180E24/E27 190E24/E27 - 325E27	42532610 93159509
13	<b>727950</b>	Staffa per cilindro freno motore / <i>Exhaust brake bracket</i>	EUROTECH { 180E24/E27 190E24/E27 - 325E27	93191098
14	<b>718145</b>	Cilindretto comando freno motore / <i>Exhaust brake cylinder</i>	EUROTECH { 180E24/E27 190E24/E27 - 325E27	41022031
15	<b>716804</b>	Freno motore completo U.T. / <i>Exhaust brake assy</i>	EUROTECH - EUROSTAR-EUROTRAKKER	8188890
16	<b>716546</b>	Freno motore / <i>Exhaust brake</i>	EUROTECH - EUROSTAR-EUROTRAKKER	42124922
17	<b>718144</b>	Cilindretto comando freno motore / <i>Exhaust brake cylinder</i>	EUROTECH - EUROSTAR-EUROTRAKKER	41022032 8194594
18	<b>717632</b>	Pompa acqua completa / <i>Complete water pump</i> (adattabile a MOTORE 8280.42S) / (ENGINE TYPE 8280.42S)	EUROSTAR 190E52-240E52-440E52	500300470 4812406
19	<b>717670</b>	Pompa acqua completa / <i>Water pump assy</i> (adattabile a motore Cursor 7790 cc. a 6 Cilindri) (ENGINE TYPE 7790 cc. CURSOR - 6 CYLINDERS)	EUROTECH - EUROTRAKKER STRALIS	99483937 99460305
20	<b>717663</b>	Pompa acqua completa / <i>Water pump assy</i> (Adatt. a Motore CURSOR 10 - 6 cil. 10303 cc. F3A0681) (Adatt. a Motore CURSOR 13 - 6 cil. 12876 cc. F3B0681) (ENGINE TYPE CURSOR 10/13 - 6 cil. 10303/12876 cc)	EUROTECH "Cursor" EUROSTAR "Cursor" EUROTRAKKER "Cursor" STRALIS	500356553
21	<b>717635</b>	Semipompa per pompa acqua / <i>Water semipump</i> (adattabile a MOTORE 8460 SPR 6 cil. 9500 cc) (ENGINE TYPE 8460 SPR 6 cylinder 9500 cc)	Z=23 EUROTECH { 180E30/E34 190E30/E34/E38 240E38 - 440E34/E38 400E34/E38 EUROTRAKKER 190E34H-380E34H	500350798 93190284
22	<b>717636</b>	Semipompa per pompa acqua / <i>Water semipump</i> (adattabile a MOTORE 8210.42 S5000 - LSPR - K/L) (ENGINE TYPE 8210.42 S5000 - LSPR K/L)	Z=19 EUROTECH - EUROSTAR EUROTRAKKER	500350785 98479675 99445447

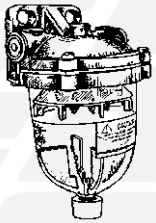

716084  
1

NEW

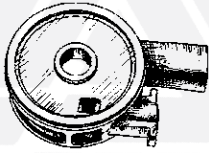

716086  
2

NEW

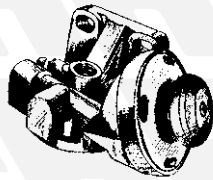

716041  
4

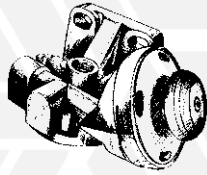

716040  
3

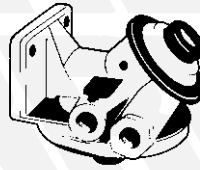

716081  
5

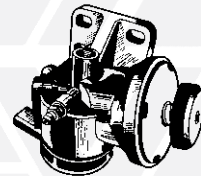

716082  
6

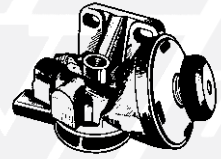

716083  
7

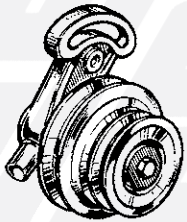

717510 - 717507  
8 9

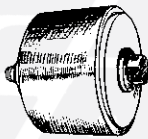

717534  
10

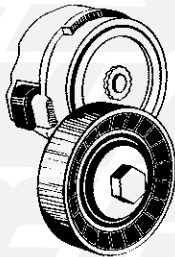

717549  
12

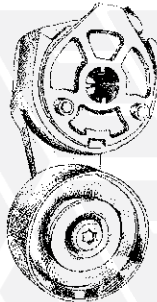

717533  
13

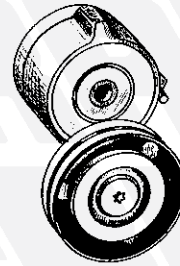

717550  
14

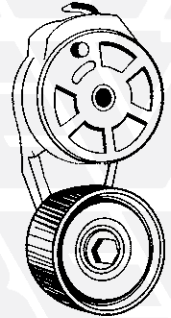

717548  
15

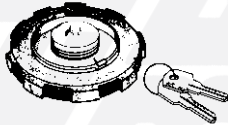

719008  
11

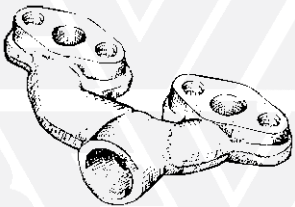

733178  
16

NEW

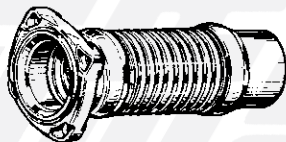

711676 - 711674  
17 18

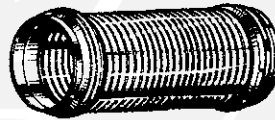

711677  
19

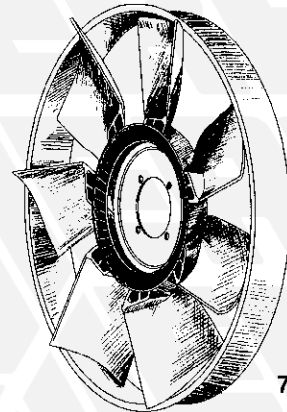

717220  
20

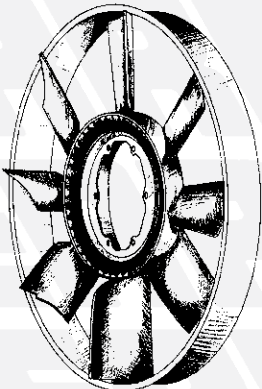

717221  
21

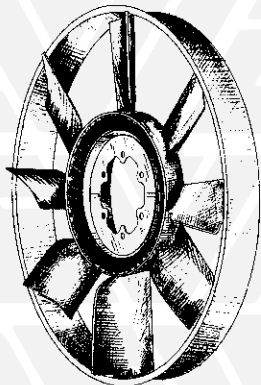

717222  
22

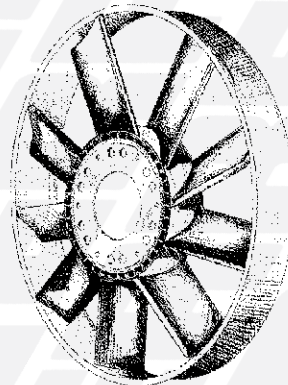

717235  
23

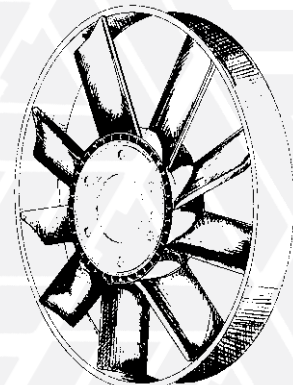

717239  
24

NEW



FIG. ITEM	RIF. ERREVI ERREVI REF.	DESCRIZIONE PARTICOLARI DESCRIPTION	TIPO VEHICLE MODEL	RIF. ORIG. ORIG. REF.
<b>260.32 TURBOTECH - EUROTECH - EUROSTAR - EUROTRAKKER EUROTECH "Cursor" - EUROSTAR "Cursor" - EUROTRAKKER "Cursor" - STRALIS</b>				
1	<b>716084</b>	Filtro combustibile / <i>Fuel filter</i>	EUROTRAKKER 380E37/E42 STRALIS 440S43	4686377 503475937
2	<b>716086</b>	Riscaldatore filtro combustibile / <i>Heater fuel filter</i>	EUROSTAR - EUROTECH STRALIS - TRAKKER	42548584 99483892
3	<b>716040</b>	Supporto filtro combustibile / <i>Fuel filter bracket</i>	EUROTECH - EUROTECH "CURSOR" EUROSTAR - EUROSTAR "CURSOR" EUROTRAKKER EUROTRAKKER "CURSOR" - STRALIS	500316868
4	<b>716041</b>	Supporto filtro combustibile / <i>Fuel filter bracket</i>	EUROTECH - EUROTECH "Cursor" EUROSTAR - EUROSTAR "Cursor" EUROTRAKKER - STRALIS EUROTRAKKER "Cursor"	42545573
5	<b>716081</b>	Supporto filtro combustibile / <i>Fuel filter bracket</i>	STRALIS - TRAKKER	42550973 504142827 504143664
6	<b>716082</b>	Supporto filtro combustibile / <i>Fuel filter bracket</i>	EUROSTAR - EUROTECH EUROTRAKKER - EUROSTAR "Cursor" EUROTECH "Cursor" - EUROTRAKKER "Cursor" - STRALIS - TRAKKER	42545831
7	<b>716083</b>	Supporto filtro combustibile / <i>Fuel filter bracket</i>	EUROSTAR - EUROSTAR "Cursor" EUROTRAKKER - EUROTRAKKER - STRALIS	50403079 500316676
8	<b>717510</b>	Supp. tendicinghia compl. 1ªS. / <i>Belt stretcher bracket</i>	EUROTECH - EUROSTAR EUROTRAKKER	98480740 4822897 98432299
9	<b>717507</b>	Supp. tendicinghia compl. U.T. / <i>Belt stretcher bracket</i>	EUROTECH - EUROSTAR EUROTRAKKER	99448867 500301088
10	<b>717534</b>	Rullo tendicinghia / <i>Belt stretcher roller</i>	EUROTECH - EUROSTAR EUROTRAKKER - EUROTECH "Cursor" EUROSTAR "Cursor" EUROTRAKKER "Cursor" - STRALIS	504006261 500318393
11	<b>719008</b>	Tappo per serbatoio nafta con chiave / <i>Fuel tank cap</i>	EUROTECH EUROSTAR EUROTRAKKER STRALIS	500043667 2993918 500302656 42124439 42038802 41036218 2534687
12	<b>717549</b>	Tendicinghia completo / <i>Belt stretcher</i>	EUROTECH 440E31/E35 EUROTRAKKER 190E31/E35 STRALIS	99449176
13	<b>717533</b>	Tendicinghia completo / <i>Belt stretcher</i>	EUROTECH - EUROSTAR EUROTRAKKER - EUROTECH "Cursor" EUROSTAR "Cursor" EUROTRAKKER "Cursor" - STRALIS	504046191 99471920
14	<b>717550</b>	Tendicinghia completo / <i>Belt stretcher</i>	EUROTECH "Cursor" EUROSTAR "Cursor" EUROTRAKKER "Cursor" - STRALIS	500350419
15	<b>717548</b>	Tendicinghia completo / <i>Belt stretcher</i>	STRALIS 190S30/S35 - 260S31/S35/S36	504072744
16	<b>733178</b>	Tubo aria compressore / <i>Exhaust elbow</i>	EUROTECH - EUROSTAR EUROTRAKKER	-
17	<b>711676</b>	Tubo flessibile scarico / <i>Exhaust flexible pipe</i>	L=mm 325 ø est. tubo mm 103 EUROTECH - EUROSTAR EUROTRAKKER	8162322 8137150
18	<b>711674</b>	Tubo flessibile scarico / <i>Exhaust flexible pipe</i>	L=mm 290 ø est. tubo mm 105 EUROSTAR	42092241
19	<b>711677</b>	Tubo flessibile scarico / <i>Exhaust flexible pipe</i>	L=mm 240 ø est. tubo mm 105 EUROTECH - EUROSTAR	42094753
20	<b>717220</b>	Ventilatore a 7 pale / <i>7-Blades fan</i>	ø 82,5/550 EUROTECH 190E26 - 240E26	500353523
21	<b>717221</b>	Ventilatore a 8 pale / <i>8-Blades fan</i>	ø 180/705 EUROTECH - EUROTECH Cursor EUROSTAR - EUROTRAKKER EUROTRAKKER "CURSOR"	99450016
22	<b>717222</b>	Ventilatore a 8 pale / <i>8-Blades fan</i>	ø 127/654 EUROTECH - EUROTECH "CURSOR" EUROTRAKKER EUROTRAKKER "CURSOR" - STRALIS	98458607
23	<b>717235</b>	Ventilatore a 9 pale / <i>9-Blades fan</i>	ø 178/704 EUROTRAKKER STRALIS	504026023 41213992
24	<b>717239</b>	Ventilatore a 9 pale / <i>9-Blades fan</i>	ø 180/705 STRALIS	504235059

**1** MAN

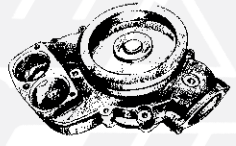

717646  
1



717653  
2

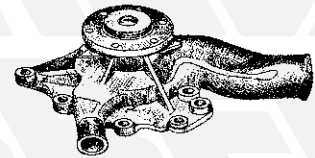

717656  
3

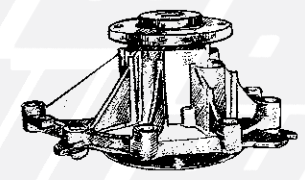

717665  
4

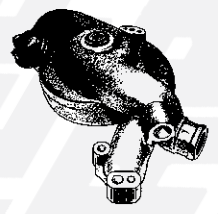

717672  
5

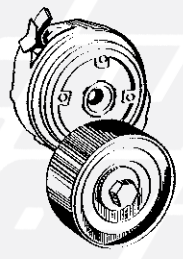

717525  
6

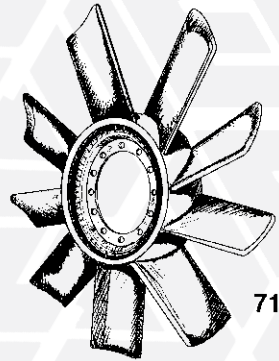

717223  
7

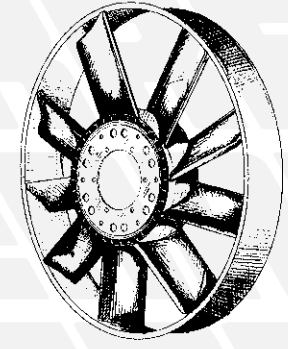

8 - 711225

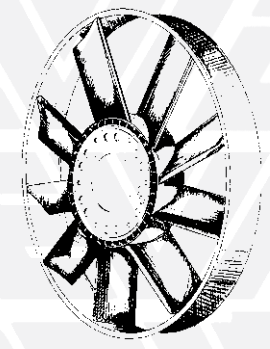

9 - 717237 **NEW**

**2** MERCEDES



732605  
10

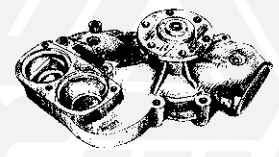

717648  
11

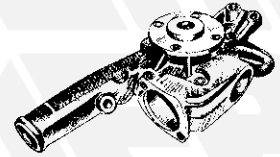

717649  
12

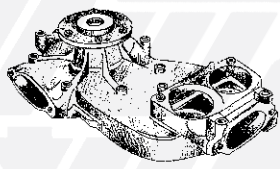

717658  
13



730973  
14



730974  
15



730975  
16

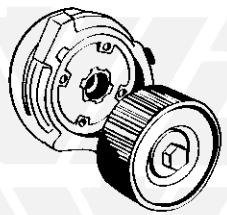

717537  
17

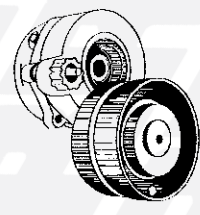

717538  
18

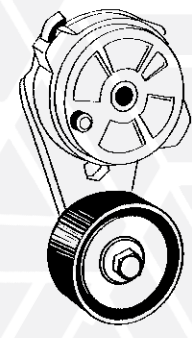

717539  
19

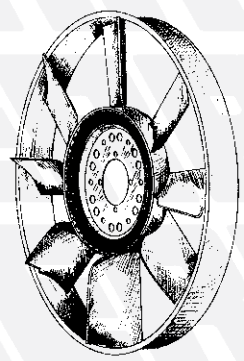

717226  
20

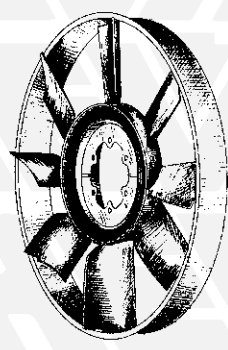

717227  
21

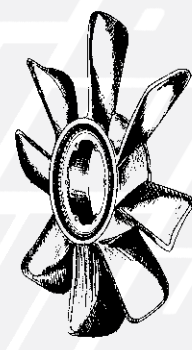

717228  
22

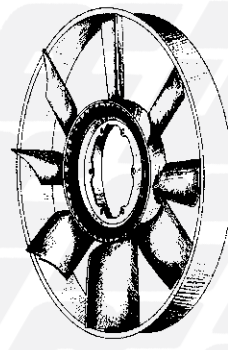

717229  
23

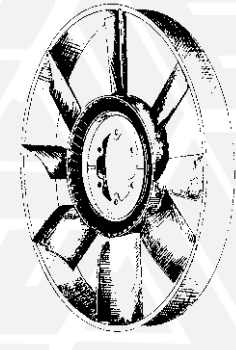

717236 **NEW**  
24

FIG. ITEM	RIF. ERREVI ERREVI REF.	DESCRIZIONE PARTICOLARI DESCRIPTION	TIPO VEHICLE MODEL	RIF. ORIG. ORIG. REF.
<div style="text-align: center;"> <span style="font-size: 2em; border: 1px solid black; border-radius: 50%; padding: 5px;">1</span> <span style="font-size: 2em; font-weight: bold; color: green;">MAN</span> </div>				
1	<b>717646</b>	Pompa acqua completa / <i>Complete water pump</i>	F2000 - F90 - M90	51065006545 51065006547 51065009547
2	<b>717653</b>	Pompa acqua completa / <i>Complete water pump</i>	<b>F2000 (Veicoli con RITARDATORE) (Vehicles with RETARDER)</b>	51065006546 51065009546
3	<b>717656</b>	Pompa acqua completa / <i>Complete water pump</i>	Girante/Impeller 135 mm F2000 - L2000 - M2000 - M90	51065006495 51065009495
4	<b>717665</b>	Pompa acqua completa / <i>Water pump assy</i>	F2000 - TGA - TGS - TGX	51065007049 51065009049 51065006637
5	<b>717672</b>	Pompa acqua completa / <i>Water pump assy</i>	TGA - F2000	51065007066 51065007051 51065009051 51065009052 51065009066
6	<b>717525</b>	Tendicinghia completo / <i>Belt stretcher</i>	TGA - TGS - TGX	51958007436 51958007429 51958007428 51958007459 51958007477
7	<b>717223</b>	Ventilatore a 9 pale / <i>9-Blades fan</i>	ø 125/620	51066010102
8	<b>717225</b>	Ventilatore a 9 pale / <i>9-Blades fan</i>	ø 127/704 TGA	51066010256
9	<b>717237</b>	Ventilatore a 9 pale / <i>9-Blades fan</i>	ø 178/750 TGA - TGS - TGX	51066010275
<div style="text-align: center;"> <span style="font-size: 2em; border: 1px solid black; border-radius: 50%; padding: 5px;">2</span> <span style="font-size: 2em; font-weight: bold; color: green;">MERCEDES</span> </div>				
10	<b>732605</b>	Kit filtro pompa aliment.-Tipo BOSCH <i>Feed pump filter kit (BOSCH type)</i>	Veicoli medi/medieleggeri/pesanti <i>Medium/H.D. vehicles</i>	0000910840
11	<b>717648</b>	Pompa acqua completa / <i>Complete water pump</i>	1019 - 1819 - 1926 - 1932 - 2626 2632 - 2636 - 3333 - 3535	4032005101 4032007101
12	<b>717649</b>	Pompa acqua completa / <i>Complete water pump</i>	VARIO - AXOR - ATEGO	9042000401 9042000801 9042002601 9042004901
13	<b>717658</b>	Pompa acqua completa / <i>Complete water pump</i>	ACTROS	5422000601 5422001601 5422002001
14	<b>730973</b>	Supporto anteriore motore / <i>Engine mounting, front</i>	ACTROS	9412415413 9412417413 9412418413
15	<b>730974</b>	Supporto anteriore e posteriore motore <i>Engine mounting, front and rear</i>	ACTROS ACTROS MP2	9412411713 9412414713 9412415713 9412417713
16	<b>730975</b>	Supporto anteriore e posteriore motore <i>Engine mounting, front and rear</i>	ACTROS ACTROS MP2	9412411813 9412414813 9412415813 9412417813 9412418813
17	<b>717537</b>	Tendicinghia completo / <i>Belt stretcher</i>	ATEGO	9062002070 9062001470 9062001770
18	<b>717538</b>	Tendicinghia completo / <i>Belt stretcher</i>	ATEGO- AXOR	4572002270
19	<b>717539</b>	Tendicinghia completo / <i>Belt stretcher</i>	ACTROS	5412000870 5412001570
20	<b>717226</b>	Ventilatore a 8 pale / <i>8-Blades fan</i>	ø 82/595 ATEGO	9042050406
21	<b>717227</b>	Ventilatore a 8 pale / <i>8-Blades fan</i>	ø 180/750 ATEGO - AXOR	0032053606
22	<b>717228</b>	Ventilatore a 8 pale / <i>8-Blades fan</i>	ø 180/720 ACTROS	0032050006 5412050106
23	<b>717229</b>	Ventilatore a 8 pale / <i>8-Blades fan</i>	ø 180/750 ACTROS	0032050106
24	<b>717236</b>	Ventilatore a 8 pale / <i>8-Blades fan</i>	ø 242/750 ACTROS - ACTROS MP2	0032054206 0032053906

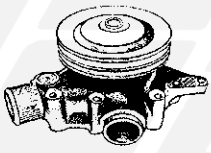

717666  
1

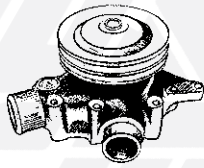

717668  
2

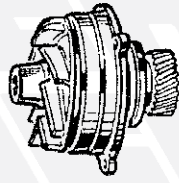

717667  
3

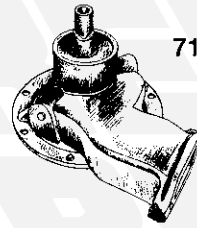

717637  
4

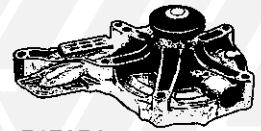

717674  
5

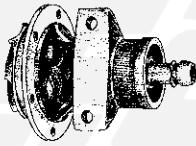

717659  
6

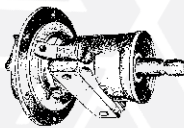

717660  
7

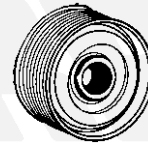

717556  
8

**NEW**

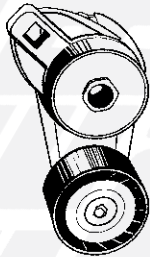

717542  
9

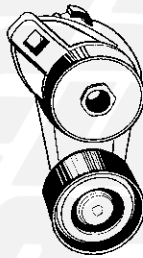

717546  
10

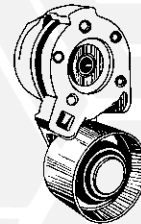

717541  
11

FIG. ITEM	RIF. ERREVI ERREVI REF.	DESCRIZIONE PARTICOLARI DESCRIPTION	TIPO VEHICLE MODEL	RIF. ORIG. ORIG. REF.
<b>RENAULT</b>				
1	<b>717666</b>	Pompa acqua completa / <i>Complete water pump</i>	MIDLINER	5010258977
2	<b>717668</b>	Pompa acqua completa / <i>Complete water pump</i>	MIDLUM - PREMIUM	5010553652
3	<b>717667</b>	Pompa acqua completa / <i>Complete water pump</i>	Z = 22 PREMIUM	5001857427 5001858484
4	<b>717637</b>	Pompa acqua completa / <i>Complete water pump</i>	MAGNUM	5010284179 5200538288
5	<b>717674</b>	Pompa acqua completa / <i>Complete water pump</i>	MAGNUM - PREMIUM PREMIUM 2	7485000763 7420744939
6	<b>717659</b>	Semipompa per pompa acqua / <i>Water semipump</i>	MAGNUM	5010248921
7	<b>717660</b>	Semipompa per pompa acqua / <i>Water semipump</i>	MAGNUM	0000773450 0000773983 5010323187
8	<b>717556</b>	Puleggia tendicinghia / <i>Belt stretcher pulley</i>	PREMIUM - PREMIUM 2 KERAX	7408086970
9	<b>717542</b>	Tendicinghia completo / <i>Belt stretcher</i>	PREMIUM - MAGNUM	7420487079
10	<b>717546</b>	Tendicinghia completo / <i>Belt stretcher</i>	PREMIUM 2	5010550335
11	<b>717541</b>	Tendicinghia completo / <i>Belt stretcher</i>	MAGNUM	5010553993 5010284807

**MOTORE  
ENGINE**

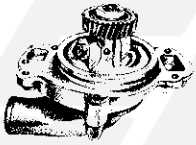

717640  
1

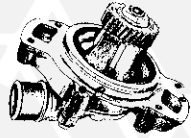

717641  
2

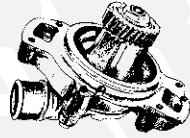

717642  
3

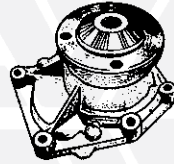

717673  
4

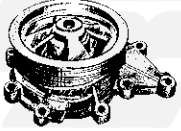

717643  
5

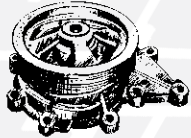

717676  
6

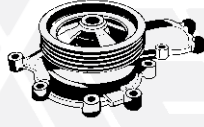

717681  
7



730417  
8



730416  
9



730890  
10

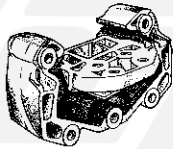

730415  
11

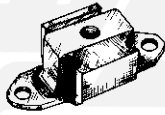

730994  
12



717544  
13



717555  
14

**NEW**

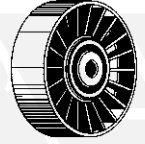

717554  
15

**NEW**

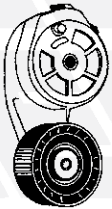

717543  
16

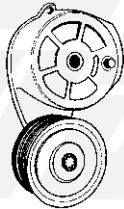

717545  
17

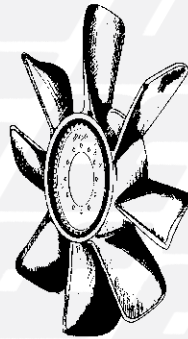

717231  
18



717230  
19

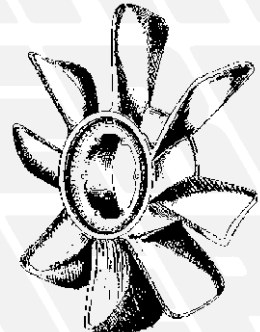

717242  
20

**NEW**

FIG. ITEM	RIF. ERREVI ERREVI REF.	DESCRIZIONE PARTICOLARI DESCRIPTION		TIPO VEHICLE MODEL	RIF. ORIG. ORIG. REF.
<b>SCANIA</b>					
1	<b>717640</b>	Pompa acqua completa / <i>Complete water pump</i>		142	292762 320592
2	<b>717641</b>	Pompa acqua completa / <i>Complete water pump</i>	Z = 33	143	382183 1375838 571153
3	<b>717642</b>	Pompa acqua completa / <i>Complete water pump</i>	Z = 33	143 (Veicoli con <b>ritardatore</b> ) 143 ( <i>Vehicle complete with retarder</i> )	571154 1375839
4	<b>717673</b>	Pompa acqua completa (adattabile a motore DSC9-DS9AM-DSI9AM) <i>Water pump assy (engine type DSC9 - DS9AM - DSI9AM)</i>		94	1510490 1486098 1380897
5	<b>717643</b>	Pompa acqua completa / <i>Complete water pump</i>		114 - 124 - 144	1365841 1508534
6	<b>717676</b>	Pompa acqua completa (adattabile a motore DSC11-DSC12) <i>Complete water pump (engine type DSC11-DSC12)</i>		94 - 114 - 124 - 144 - 164	1353072 1508533
7	<b>717681</b>	Pompa acqua completa (adattabile a motore DSC16 - 8 cilindri) <i>Complete water pump (engine type DSC16 - 8 cylinders)</i>		164	1549482 1510404 570954 1549481 1433792
8	<b>730417</b>	Supporto posteriore motore / <i>Rear engine stretcher</i>		Serie 2 / 2 Series Serie 3 / 3 Series	364833 278599
9	<b>730416</b>	Supporto anteriore motore / <i>Front engine stretcher</i>		94 - 114 - 124	1496288 1423011 1336885
10	<b>730890</b>	Supporto posteriore motore / <i>Rear engine stretcher</i>		94 - 114 - 124	1921972 1449287 1469287 1779609 1782203
11	<b>730415</b>	Supporto posteriore motore / <i>Rear engine stretcher</i>		94 - 114 - 124 - 144	1336882
12	<b>730994</b>	Supporto radiatore / <i>Radiator mounting</i>		94 - 114 - 124	1363634
13	<b>717544</b>	Puleggia tendicinghia / <i>Belt stretcher pulley</i>		94 - 114 - 124 - 144 - 164	1353717 1428940 1514086
14	<b>717555</b>	Puleggia tendicinghia / <i>Belt stretcher pulley</i>		164 Serie P - G - R - T Series	477751 1413609 1428941 1514087
15	<b>717554</b>	Puleggia tendicinghia / <i>Belt stretcher pulley</i>		114 Serie P - G - R - T Series	1510697 1512749 1795775 1858885
16	<b>717543</b>	Tendicinghia completo / <i>Belt stretcher</i>		94 - 114 - 124 - 144 - 164	1503113 1545982 1774651 1859654
17	<b>717545</b>	Tendicinghia completo / <i>Belt stretcher</i>		94 - 114 - 124 - 144 - 164	1438743 1503115 1545984 1899656 1774653
18	<b>717231</b>	Ventilatore a 8 pale / <i>8-Blades fan</i>	ø 125/750	114 - 124	1354979
19	<b>717230</b>	Ventilatore a 8 pale / <i>8-Blades fan</i>	ø 180/730	114 - 124	1393424
20	<b>717242</b>	Ventilatore a 8 pale / <i>8-Blades fan</i>	ø est 680	Serie P - G - R - T Series 94 - 114 - 124 - 144 - 164	1412398 1354980 1402869 571083 571084

**MOTORE  
ENGINE**

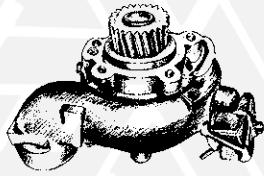

717639  
1

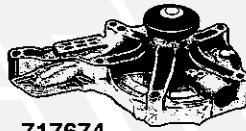

717674  
2

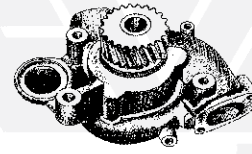

717661  
3

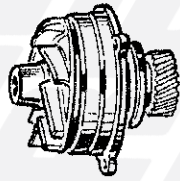

717651  
4



730426  
5

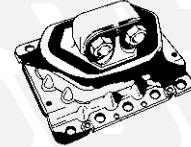

730930  
6



730948  
7



730949  
8

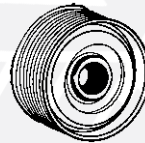

717556  
9

**NEW**

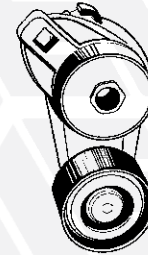

717546  
10

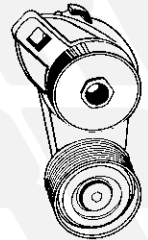

717547  
11



FIG. ITEM	RIF. ERREVI ERREVI REF.	DESCRIZIONE PARTICOLARI DESCRIPTION		TIPO VEHICLE MODEL	RIF. ORIG. ORIG. REF.
<b>VOLVO</b>					
1	<b>717639</b>	Pompa acqua completa / <i>Complete water pump</i>		FL10 - FL12 - FH12	1547155 8148460 8149941
2	<b>717674</b>	Pompa acqua completa / <i>Complete water pump</i>		FM - FM9 - FH16	3161436 20538845 20744939
3	<b>717661</b>	Pompa acqua completa / <i>Complete water pump</i>		FL6 - FL7 - FM7	276835 3183908 8112185 8192050 20575653
4	<b>717651</b>	Semipompa per pompa acqua / <i>Water semipump</i>	Z = 27	FH12 - FM12 - NH12	8170305 20431135 20734268
5	<b>730426</b>	Supporto posteriore motore / <i>Rear engine stretcher</i>		FH12 - FH16	1629614 3198122 20399980
6	<b>730930</b>	Supporto posteriore motore / <i>Rear engine stretcher</i>		FH12 - FH16 - FM	20723224 21228153 20499469
7	<b>730948</b>	Supporto anteriore motore, inferiore <i>Front engine mounting, bottom</i>	ø 102	F10 - F12 - F16 - N7 - N10	1503490 1503489
8	<b>730949</b>	Supporto anteriore motore, superiore / <i>Front engine mounting, top</i>	ø 112	F10 - F12 - F16 - N7 - N10	1623745 1618777 1502144 1502352
9	<b>717556</b>	Puleggia tendicinghia / <i>Belt stretcher pulley</i>		FM - FM9 - B9	8086970
10	<b>717546</b>	Tendicinghia completo / <i>Belt stretcher</i>		FM10 - FM12 - FH12	3979980
11	<b>717547</b>	Tendicinghia completo / <i>Belt stretcher</i>		FH16	20491753 21145261 21155561

**MOTORE ENGINE**

# 1 RICAMBI PER COMPRESSORI / COMPRESSOR PARTS

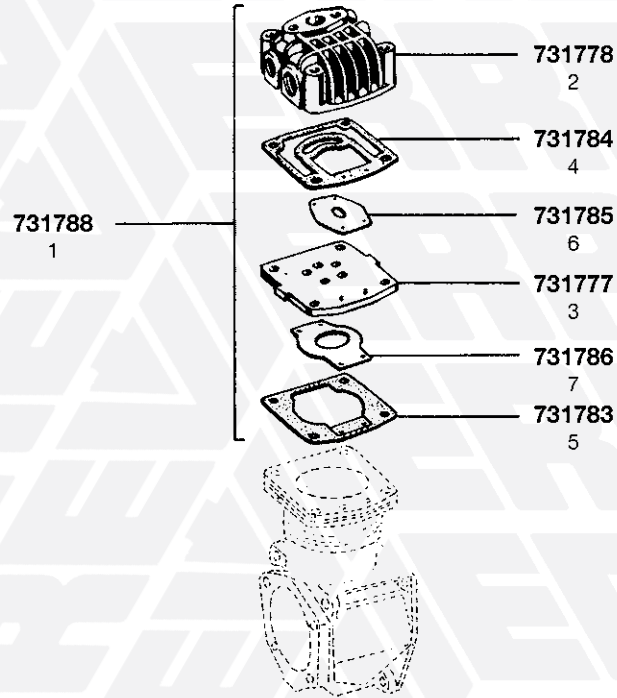

## 2

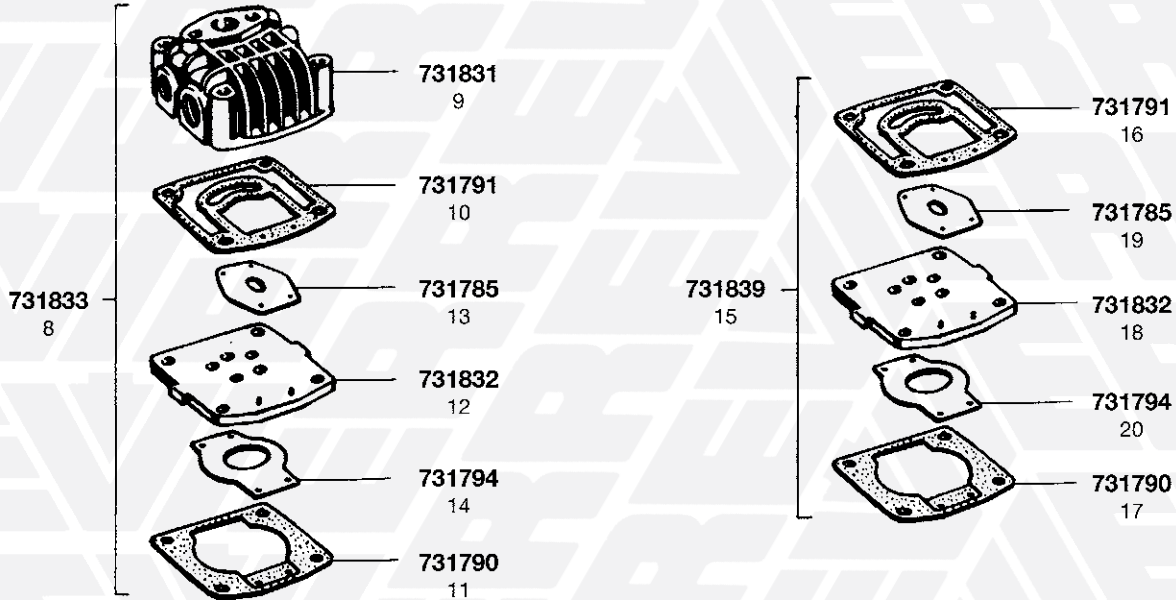

## 3

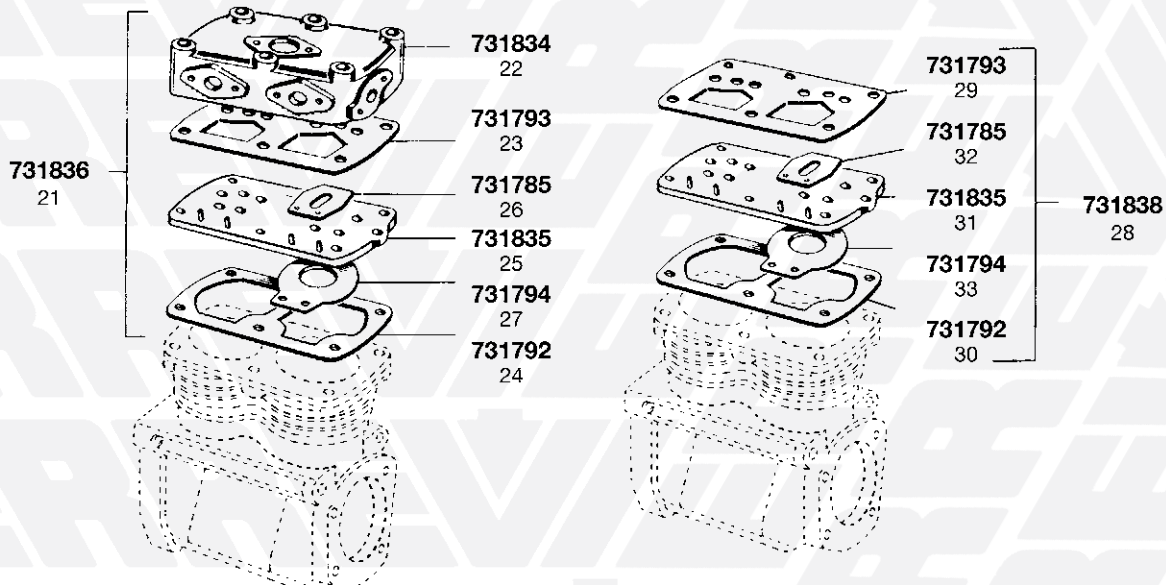
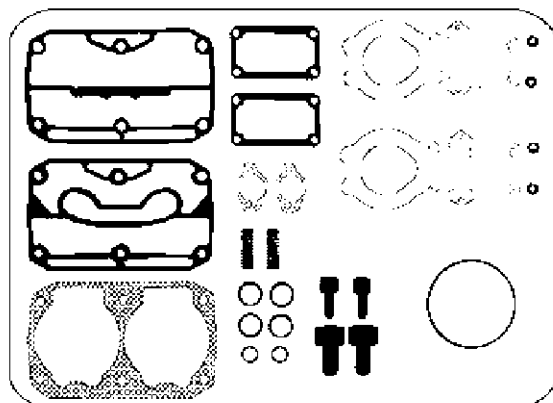

FIG. ITEM	RIF. ERREVI ERREVI REF.	DESCRIZIONE PARTICOLARI DESCRIPTION	TIPO VEHICLE MODEL	RIF. ORIG. ORIG. REF.
<b>RICAMBI PER COMPRESSORI / COMPRESSOR PARTS</b>				
<b>① TIPO /TYPE 4657229 (AC61ZA) - 4679624 (AC63ZB) - 4707537 (AC64ZD) MONOCILINDRICO NORMALE - STD</b>				
1	<b>731788</b>	<b>Complessivo testata composto da: Compressor head kit, inclusive of:</b>	M 76695902	93161600 M 76695902 79035552
2	<b>731778</b>	(1) Coperchio nudo per testata / <i>Cylinder head cover, bare</i>		-
3	<b>731777</b>	(1) Piastra portavalvole / <i>Plate</i>	M 75381802	9926681
4	<b>731784</b>	(1) Guarnizione sup. coperchio testata / <i>Cylinder head cover gasket, top</i>	M 75323102	9921899
5	<b>731783</b>	(1) Guarnizione inf. coperchio testata / <i>Cylinder head cover gasket, bottom</i>	M 75336202	9008465
6	<b>731785</b>	(1) Valvola sup. per piastra / <i>Valve, top</i>	M 75315812	9008471
7	<b>731786</b>	(1) Valvola inf. per piastra / <i>Valve, bottom</i>	M 75336512	9008469
<b>② TIPO /TYPE 771373 (AC67A) - 4802598 (AC67BA) - 61688012 MONOCILINDRICO MAGGIORATO - OVERSIZE</b>				
8	<b>731833</b>	<b>Complessivo testata composto da: Compressor head kit, inclusive of:</b>	M 76694102	79073083 M 76694102 9981658
9	<b>731831</b>	(1) Coperchio sup. per testata / <i>Cylinder head cover, bare</i>		-
10	<b>731791</b>	(1) Guarnizione sup. per coperchio testata / <i>Cover gasket, top</i>	M 75481610	9982584
11	<b>731790</b>	(1) Guarnizione inf. per coperchio testata / <i>Cover gasket, bottom</i>	M 75481510	9982583
12	<b>731832</b>	(1) Piastra portavalvole / <i>Plate</i>	M 75481001	9982495
13	<b>731785</b>	(1) Valvola sup. per testata / <i>Valve, top</i>	M 75315812	9008471
14	<b>731794</b>	(1) Valvola inf. per testata / <i>Valve, bottom</i>	M 75365312	9922618
15	<b>731839</b>	<b>Complessivo piastra compressore completo di valvole e guarnizioni composto da: / Compressor plate kit, inclusive of:</b>		93161595 79035741
16	<b>731791</b>	(1) Guarnizione sup. per coperchio testata / <i>Cover gasket, top</i>	M 75481610	9982584
17	<b>731790</b>	(1) Guarnizione inf. per coperchio testata / <i>Cover gasket, bottom</i>	M 75481510	9982583
18	<b>731832</b>	(1) Piastra portavalvole / <i>Plate</i>	M 75481001	9982495
19	<b>731785</b>	(1) Valvola sup. per testata / <i>Valve, top</i>	M 75315812	9008471
20	<b>731794</b>	(1) Valvola inf. per testata / <i>Valve, bottom</i>	M 75365312	9922618
<b>③ TIPO /TYPE MI (4713813 AC75ZD) BICILINDRICO - BICYLINDER</b>				
21	<b>731836</b>	<b>Complessivo testata composto da: Compressor plate kit, inclusive of:</b>	M 76694802	93161598 M 76694802 79098366
22	<b>731834</b>	(1) Coperchio sup. / <i>Top cover</i>		-
23	<b>731793</b>	(1) Guarnizione sup. / <i>Gasket, top</i>	M 75421011	9926931
24	<b>731792</b>	(1) Guarnizione inf. / <i>Gasket, bottom</i>	M 75420911	9926930
25	<b>731835</b>	(1) Piastra / <i>Plate</i>	M 75372302	9922619
26	<b>731785</b>	(2) Valvola sup. / <i>Valve, top</i>	M 75315812	9008471
27	<b>731794</b>	(2) Valvola inf. / <i>Valve, bottom</i>	M 75365312	9922618
28	<b>731838</b>	<b>Complessivo piastra composto da: Compressor plate kit, inclusive of:</b>	M 76689901	93161594 M 76689901 79098367
29	<b>731793</b>	(1) Guarnizione sup. / <i>Gasket, top</i>	M 75421011	9926931
30	<b>731792</b>	(1) Guarnizione inf. / <i>Gasket, bottom</i>	M 75420911	9926930
31	<b>731835</b>	(1) Piastra / <i>Plate</i>	M 75372302	9922619
32	<b>731785</b>	(2) Valvola sup. / <i>Valve, top</i>	M 75315812	9008471
33	<b>731794</b>	(2) Valvola inf. / <i>Valve, bottom</i>	M 75365312	9922618

FIG. ITEM	RIF. ERREVI ERREVI REF.	DESCRIZIONE PARTICOLARI DESCRIPTION	TIPO VEHICLE MODEL	RIF. ORIG. ORIG. REF.
-----------	-------------------------	-------------------------------------	--------------------	-----------------------

## RICAMBI PER COMPRESSORI / COMPRESSOR PARTS



**731840**  
1

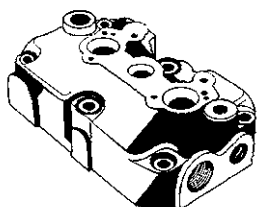

**731841**  
2

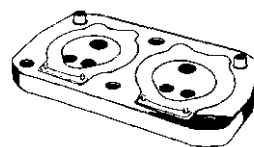

**731842**  
3

1	<b>731840</b>	Compressivo valvole e guarnizioni per compressore <i>Compressor valves and gaskets kit</i>	EUROTECH "Cursor" EUROSTAR "Cursor" EUROTRAKKER "Cursor" TRAKKER STRALIS	190E35 190E39 190E35	42549150 42536661
2	<b>731841</b>	Coperchio superiore testata compressore <i>Cylinder head cover, bare</i>	EUROTECH "Cursor" EUROSTAR "Cursor" EUROTRAKKER "Cursor" TRAKKER STRALIS	190E35 190E39 190E35	42549152
3	<b>731842</b>	Piastra portavalvole per compressore / <i>Compressor plate</i>	EUROTECH "Cursor" EUROSTAR "Cursor" EUROTRAKKER "Cursor" TRAKKER STRALIS	190E35 190E39 190E35	42549149 42549153