

DIFFERENZIALE E MOZZI POSTERIORI REAR AXLE AND WHEELS

RICAMBI PER / SPARE PARTS FOR

ASTRA	pag.	92 - 93
DAF	pag.	92 - 95
IVECO	pag.	96 - 115
MAN	pag.	116 - 119
MERCEDES	pag.	120 - 123
NISSAN	pag.	124 - 125
RENAULT	pag.	124 - 125
SCANIA	pag.	126 - 127
VOLVO	pag.	128 - 131

PONTE POST.
REAR AXLE

1



729336
1



729055
2

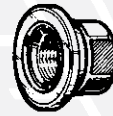

729657
3



728910
4

2

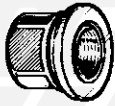

729629
9



7 - 729342
8 - 729341



729399
5

NEW



729398
6



729784
10



11 - 728722
12 - 728723
13 - 728724
14 - 728725
15 - 728727
16 - 728729
17 - 728636



730783
18



730784
19



730789
20

NEW



21 - 730782
22 - 730781



730790
23

NEW

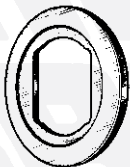

726375
24



726376
25



727259
26



727262
27

FIG. ITEM	RIF. ERREVI ERREVI REF.	DESCRIZIONE PARTICOLARI DESCRIPTION	TIPO VEHICLE MODEL	RIF. ORIG. ORIG. REF.
<div style="display: flex; align-items: center;"> <div style="font-size: 2em; margin-right: 10px;">1</div> <div> <h2 style="margin: 0;">ASTRA</h2> <p style="margin: 0;">BM20 - BM21F - BM304F - BM305F - BM64.26 - BM64.30 - BM64.36 HD7 (64.34 - 64.38 - 64.42 - 64.45 - 64.52) - HD8 (4x2 - 4x4 - 6x4 - 6x6 - 8x4)</p> </div> </div>				
1	729336	Colonna fissaggio mozzi / <i>Wheel stud</i>	M22x1,5 L=107	BM304F - BM305F 101788 103253
2	729055	Colonna fissaggio mozzi / <i>Wheel stud</i>	M22x1,5 L=111	BM 64.26/.30/.36 HD7 (64.34/.38/.42/.45/.52) HD8 (4x2 - 4x4 - 6x4 - 6x6 - 8x4) 112329 115498 42061641 42101367 111445
3	729657	Dado per colonna / <i>Wheel nut</i>	M22x1,5	HD8 (4x2 - 4x4 - 6x4 - 6x6 - 8x4) 40051
4	728910	Tassello fissaggio ruota - foro ø 20 / <i>Wheel pad, hole ø 20</i>		BM20 - BM21F 16320
<div style="display: flex; align-items: center;"> <div style="font-size: 2em; margin-right: 10px;">2</div> <div> <h2 style="margin: 0;">DAF</h2> </div> </div>				
5	729399	Colonna fissaggio ruota / <i>Wheel stud</i>	M18x1,5 L= 78	LF45 - LF55 1400267
6	729398	Colonna fissaggio ruota / <i>Wheel stud</i>	M20x1,5 L=85	LF45 - LF55 1400065 PAK4938
7	729342	Colonna fissaggio ruota / <i>Wheel stud</i>	M22x1,5 L=94	85CF - 85FA - 95FA - 95XF 1309190 1356736 890763
8	729341	Colonna fissaggio ruota / <i>Wheel stud</i>	M22x1,5 L=104	2100 - 2300 - 2500 - 2800 - 3600 620649 99717 1308038
9	729629	Dado per colonna / <i>Wheel nut</i>	M22x1,5	2100 - 2300 - 2500 - 2800 - 3600 652575
10	729784	Dado fissaggio mozzo / <i>Wheel nut</i>	M86x2	1396548
11	728722	Cuscinetto mozzo / <i>Hub bearing</i>	ø 90x140x32	0077060 32018XA VKHB2170
12	728723	Cuscinetto mozzo / <i>Hub bearing</i>	ø 95x145x32	LF55 - 65CF 0622103 32019XA VKHB2161
13	728724	Cuscinetto mozzo / <i>Hub bearing</i>	ø 100x150x32	699117 32020X VKHB2306
14	728725	Cuscinetto mozzo / <i>Hub bearing</i>	ø 110x170x38	1453936 VKHB2281 32022X
15	728727	Cuscinetto mozzo / <i>Hub bearing</i>	ø 105x160x43	65CF - 75CF - 85CF - 95FA - 95XF CF65 CF75 - CF85 - XF195 - XF105 LF45 266488-33021 VKHB2162
16	728729	Cuscinetto mozzo / <i>Hub bearing</i>	ø 75x125x37	221664-33115 VKHB2222
17	728636	Cuscinetto esterno mozzo (33116) <i>Outer bearing</i>	ø 80x130x37	0836586 1489089
18	730783	Paraolio interno mozzo / <i>Oil seal, inner</i>	ø 100x135x13	65CF - 75CF - 85CF - 95XF 0647330
19	730784	Paraolio interno mozzo / <i>Oil seal, inner</i>	ø 100x140x20	65CF - 75CF - 85CF - 95XF 1238034
20	730789	Paraolio interno mozzo / <i>Oil seal, inner</i>	ø 112x170x27	75CF - 85CF - 95XF 190069
21	730782	Paraolio interno mozzo / <i>Oil seal, inner</i>	ø 120x164,5x19,5	65CF - 75CF 0678157
22	730781	Paraolio interno mozzo / <i>Oil seal, inner</i>	ø 124,5x164,5x17,5	75CF - 85CF - 95XF - CF65 CF75 - CF85 0292766
23	730790	Paraolio interno mozzo / <i>Oil seal, inner</i>	ø 124,5x190x22	65CF - 75CF - 85CF - 95XF CF65 - CF75 - CF85 1335063
24	726375	Rondella fissaggio mozzo / <i>Retaining washer</i>	ø 69,5x119x9	LF55 - CF65 - CF75 - CF85 XF95 - XF105 1692215
25	726376	Rondella fissaggio mozzo / <i>Retaining washer</i>	ø 69,5x119x9	XF95 - XF105 1692209 1385327
26	727259	Ruota fonica / <i>Impulse wheel</i>	100 denti / <i>teeth</i>	CF65 - CF75 - CF85 1805824 1657638
27	727262	Ruota fonica / <i>Impulse wheel</i>	ø 168x212x18 100 denti / <i>teeth</i>	65CF - 75CF - 85CF - CF65 CF75 - CF85 1391517 1805823

**PONTE POST.
REAR AXLE**

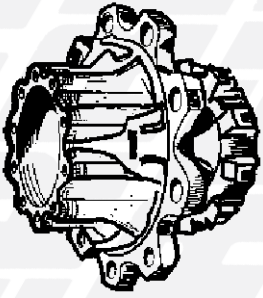

713907
Nudo / Bare
1

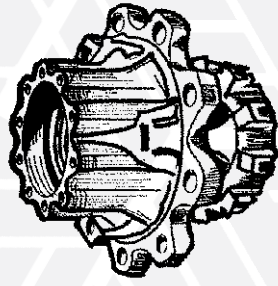

713758
Compl. / Assembly
2

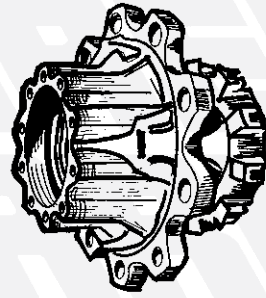

713906
Compl. FAG / FAG Assembly
3



728701
7

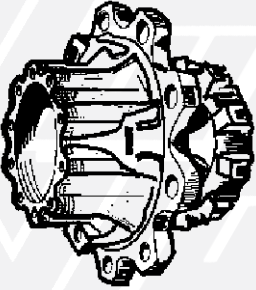

713909
Nudo / Bare
4

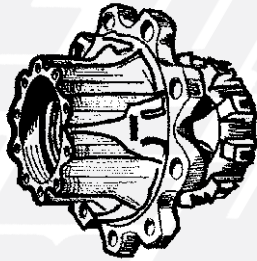

713773
Compl. / Assembly
5

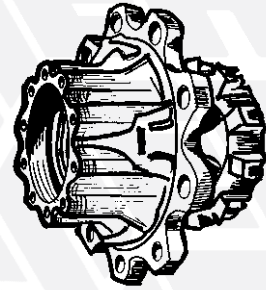

713908
Compl. FAG / FAG Assembly
6



728701
7

FIG. ITEM	RIF. ERREVI ERREVI REF.	DESCRIZIONE PARTICOLARI DESCRIPTION	TIPO VEHICLE MODEL	RIF. ORIG. ORIG. REF.
1	713907	Mozzo ruota nudo/ <i>Wheel hub, bare</i>	XF95 - 95XF	1391617S 1657637S 1818003S 1388906S
2	713758	Mozzo ruota completo / <i>Wheel hub assembly</i>	XF95 - 95XF	1391617 1657637 1818003 1388906
3	713906	Mozzo ruota completo di cuscinetto FAG <i>Wheel hub assembly (complete with FAG bearing)</i>	XF95 - 95XF	1391617 1657637 1818003 1388906
4	713909	Mozzo ruota nudo / <i>Wheel hub, bare</i>	XF95 - 95XF	1812161S
5	713773	Mozzo ruota completo U.T. / <i>Wheel hub assembly</i>	XF95 - 95XF	1812161
6	713908	Mozzo ruota con cuscinetto FAG <i>Wheel hub assembly (with FAG bearing)</i>	XF95 - 95XF	1812161
7	728701	Kit cuscinetto completo / <i>Bearing assembly</i> ø est. 148	XF95 - 95XF	1801594

**PONTE POST.
REAR AXLE**

1



729501
1

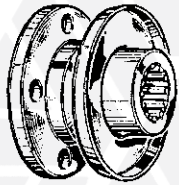

715011
2

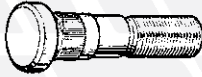

729106
3



729183
4



729184
5



729149
6



729347
7



729626
8



729763
9



728650
11

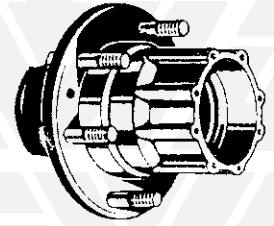

713590
10



728713
13

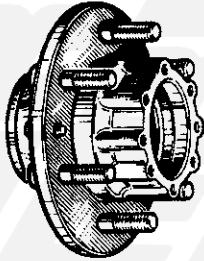

713526
12



728670
15

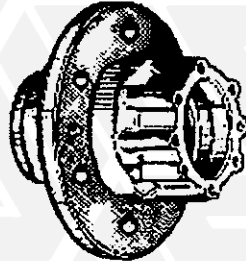

713625
14



730738
16



730768
17

2

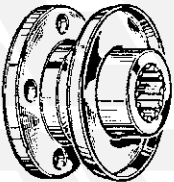

715011
18



729184
19



729626
20



729763
21



728713
23

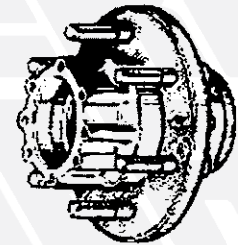

713526
22

3



729024
24



729044
28



729043
27



729026
25



726823
26

FIG. ITEM	RIF. ERREVI ERREVI REF.	DESCRIZIONE PARTICOLARI DESCRIPTION	TIPO VEHICLE MODEL	RIF. ORIG. ORIG. REF.
IVECO				
1 DAILY - NEW DAILY - TURBO DAILY (30.8 - 30.10 - 35.8 - 35.10 - 35.12 - 40.8 - 40.10 - 45.10 - 49.10 - 49.12) GRUPPO DIFFERENZIALE / DIFFERENTIAL GROUP				
1	729501	Dado per manicotto pignone / <i>Pinion nut</i>	40.8	7166475 545701 4696423
2	715011	Manicotto pignone conico / <i>Pinion driving flange</i>	30.10 - 35.10 - 35.12 - 40.10 45.10 - 49.10 - 49.12	7166992
MOZZI POSTERIORI / REAR HUBS				
3	729106	Colonna fiss. ruota (ponte salisbury) / <i>Wheel stud (salisbury rear axle)</i>	M18x1,5 L=68	32.8 - 35.8 - 40.8
4	729183	Colonna fiss. ruota (ponte FIAT) 1ª Serie / <i>Wheel stud (FIAT rear axle)</i>		30.8 - 35.8
5	729184	Colonna fiss. ruota U.T. / <i>Wheel stud</i>	M18x1,5 L=58	7168330 42119082
6	729149	Colonna fiss. ruota / <i>Wheel stud</i>	M18x1,5 L=65	2478620 42117463 46390478
7	729347	Colonna fissaggio ruota / <i>Wheel stud</i>	M18x1,5 L=75	59.12 42117465 7168333
8	729626	Dado per colonna / <i>Wheel nut</i>	M18x1,5	93805743 99474404 4459602
9	729763	Ghiera fissaggio mozzo / <i>Grooved nut</i>	M52x1,5	TUTTI I TIPI 7180039
10	713590	Mozzo ruota c/colonne - RUOTE GEMELLATE - <i>Rear hub assy - twin wheels -</i>		NO 49.12 - 59.12 7169265 7168256
11	728650	Cuscinetto interno ed esterno mozzo / <i>Hub bearing</i>	ø 55x90x23	DAILY - NEW DAILY - TURBO DAILY 30.8/.10 - 35.8/.10/.12 40.8/.10 - 45.10 - 49.10 8169268 1101597 VKHB2060
12	713526	Mozzo ruota posteriore con colonne / <i>Rear hub c/w bolts</i>		TUTTI I TIPI 7180049
13	728713	Kit cuscinetto completo / <i>Bearing assembly</i>	ø 55x90x60	NEW DAILY 35.8 TURBO DAILY 35.10/.12 - 49.10/.12 DAILY CNG 35.11 - 49.11 7187566 7180066 VKBA3552
14	713625	Mozzo ruota, nudo / <i>Rear hub, bare</i>		7172993
15	728670	Cuscinetto interno ed esterno mozzo / <i>Hub bearing</i>	ø77,8x121,5 x25,2	TURBO DAILY 59.12 DAILY CNG 59.11 1905220 VKHB2209
16	730738	Paraolio mozzi / <i>Oil seal</i>	ø70x90x12	30.8 - 35.8 - 40.8 30.10 - 35.10 - 35.12 - 40.10 40100483 40002630
17	730768	Paraolio interno mozzo in VITON / <i>Oil seal (VITON material)</i>	ø 95x130x16	59.12 TURBODAILY 59.11 DAILY CNG 7185250 40102143
2 DAILY 2000 35C9/C10/C11/C12/C13/C15 - 50C11/C13/C15 GRUPPO DIFFERENZIALE / DIFFERENTIAL GROUP				
18	715011	Manicotto pignone conico / <i>Pinion driving flange</i>		7166992
MOZZI POSTERIORI / REAR HUBS				
19	729184	Colonna fiss. ruota U.T. / <i>Wheel stud</i>	M18x1,5 L=58	42119082 7168330
20	729626	Dado per colonna / <i>Wheel nut</i>	M18x1,5	93805743 99474404 4459602
21	729763	Ghiera fissaggio mozzo / <i>Grooved nut</i>	M52x1,5	7180039
22	713526	Mozzo ruota posteriore con colonne / <i>Rear hub c/w bolts</i>		7180049
23	728713	Kit cuscinetto completo / <i>Bearing assembly</i>	ø 55x90x60	DAILY 2000 35C9/C10/C11 35C12/C13/C15 - 50C11/C13/C15 7187566 7180066 VKBA3552
3 35NC - 40NC - 45NC - 49NC - 50NC - 55NC - 65NC - 70NC - 75NC				
24	729024	Colonna fissaggio ruota / <i>Wheel stud</i>	M18x1,5 L=72	8527732
25	729026	Dado per colonna / <i>Wheel nut</i>	M18x1,5	15501521
26	726823	Fermo per ghiera mozzo / <i>Lockwasher</i>		8515168
27	729043	Rondella spaccata per colonna / <i>Lockwasher</i>		1121808 8527733
28	729044	Rondella conica per colonna / <i>Cone washer</i>		8527735

PONTE POST. REAR AXLE

1

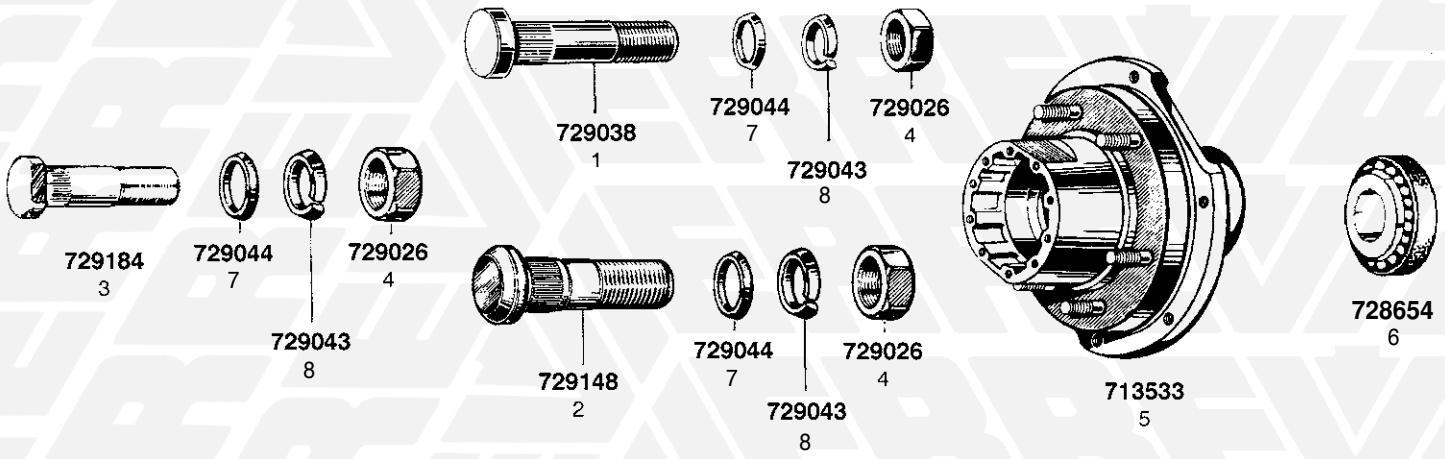

2

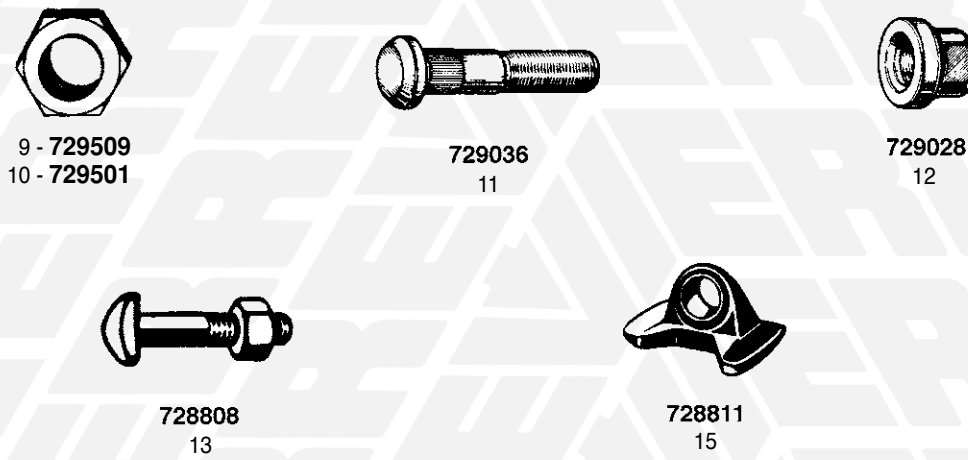

3



4

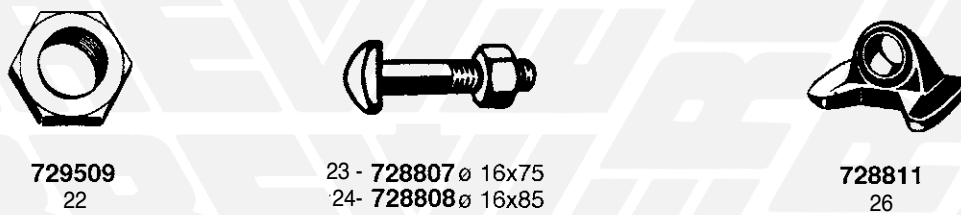

FIG. ITEM	RIF. ERREVI ERREVI REF.	DESCRIZIONE PARTICOLARI DESCRIPTION	TIPO VEHICLE MODEL	RIF. ORIG. ORIG. REF.
1 50.8/F8 - 50.9/F9 - 50.9Z - 50.10/F10 - 55.8/F8 - 55.9/F9 - 55.10/F10 - 60.8/F8 60.10/F10 - 60.11 TURBO Z - 65.9Z - 65.10/F10 - 65.12 TURBO Z 70.10/F10 - 75.10/F10 - 79.10/F10 - 79.12 TURBO Z - 79.13/F13 - 79.14 - 79.14Z				
1	729038	Colonna fissaggio ruota 1ª Serie / <i>Wheel stud</i>	M18x1,5 L=55	7161201
2	729148	Colonna fissaggio ruota 2ª Serie / <i>Wheel stud</i>	M18x1,5 L=55	7161552
3	729184	Colonna fissaggio ruota U.T. / <i>Wheel stud</i>	M18x1,5 L=58	7168346
4	729026	Dado per colonna / <i>Wheel nut</i>	M18x1,5	15501521 15501524
5	713533	Mozzo ruota con colonnette / <i>Rear hub assy</i>		4686447 4686446 7168365
6	728654	Cuscinetto interno ed esterno mozzo (VKHB2154) <i>Hub bearing</i>	ø 70x110x25 TUTTI I TIPI	1905216 7164410
7	729044	Rondella conica per colonna / <i>Cone washer</i>		8527735
8	729043	Rondella spaccata per colonna / <i>Lockwasher</i>		1121808 8527733
2 80NC - 90NC - 80.13/F13 - 90.13/F13 - 100.13/F13 - 110.14 GRUPPO DIFFERENZIALE / DIFFERENTIAL GROUP				
9	729509	Dado per manicotto pignone / <i>Pinion nut</i>	M35x1,5	4685835 4611483
10	729501	Dado per manicotto pignone / <i>Pinion nut</i>	M28x1,5 80NC - 90NC	7166475 545701
MOZZI POSTERIORI / REAR HUBS				
11	729036	Colonna fissaggio ruota / <i>Wheel stud</i>	M20x1,5 L=77,5	7161203
12	729028	Dado per colonna / <i>Wheel nut</i>	M20x1,5	2476979
13	728808	Bullone raggiera con dado / <i>Wheel stud</i>	M16x2 L=85 80NC - 90NC	4532460
14	728750	Dado per bullone raggiera / <i>Wheel nut</i>	M16x2 80NC - 90NC	4517201
15	728811	Tassello fissaggio ruota / <i>Wheel pad</i>	80NC - 90NC	4529999
3 109.14 - 115.17 - 135.14 - 135.17 GRUPPO DIFFERENZIALE / DIFFERENTIAL GROUP				
16	729509	Dado per manicotto pignone 1ª Serie / <i>Pinion nut</i>	M35x1,5	4685835
MOZZI POSTERIORI / REAR HUBS				
17	729150	Colonna fissaggio ruota / <i>Wheel stud</i>	M20x1,5 L=87	2475863
18	729028	Dado per colonna / <i>Wheel nut</i>	M20x1,5	2476979
19	728655	Cuscinetto interno ed esterno mozzo (VKHB2080) <i>Hub bearing</i>	ø 85x150x38,5	1905172 7164544
20	728656	Cuscinetto esterno mozzo / <i>Hub bearing, outer</i> (VKHB2137)	ø 75x120x31	7166346
21	730735	Paraolio esterno mozzi / <i>Oil seal, outer</i>	ø 130x100x14	40100113 40100110
4 100NC - 110NC - 130NC GRUPPO DIFFERENZIALE / DIFFERENTIAL GROUP				
22	729509	Dado per manicotto pignone / <i>Pinion nut</i>	M35x1,5 100NC - 110NC - 130NC	4685835 4611483
MOZZI POSTERIORI / REAR HUBS				
23	728807	Bullone raggiera con dado / <i>Wheel stud</i>	M16x2 L=75	4517528
24	728808	Bullone raggiera con dado / <i>Wheel stud</i>	M16x2 L=85	4532460
25	728750	Dado per bullone raggiera / <i>Wheel nut</i>	M16x2	4517201
26	728811	Tassello fissaggio ruota / <i>Wheel pad</i>		4529999

**PONTE POST.
REAR AXLE**

1



729173
1



2 - 729629 CH 32 - H 31
3 - 729657 CH 32 - H 27



4 - 728655 Est. / Outer
5 - 728657 Int. / Inner

2



729145
6



726535
8



729046
9



729029
7

3



729502
10

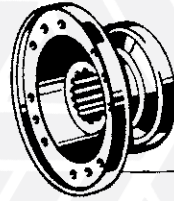

715003
11



16 - 730674 Est. / Outer
15 - 730708 Int. / Inner



12 - 728821 18x105
13 - 728822 18x125



17 - 728905

4



729511
18



19 - 728821 18x105
20 - 728822 18x125



730708
22



728905
23

FIG. ITEM	RIF. ERREVI ERREVI REF.	DESCRIZIONE PARTICOLARI DESCRIPTION	TIPO VEHICLE MODEL	RIF. ORIG. ORIG. REF.	
1 145.17 MOZZI POSTERIORI / REAR HUBS					
1	729173	Colonna fissaggio ruota / <i>Wheel stud</i>	M22x1,5 L=92	7168595	
2	729629	Dado per colonna 1ª Serie / <i>Wheel nut</i>	M22x1,5 H=31	4459603	
3	729657	Dado per colonna U.T. / <i>Wheel nut</i>	M22x1,5 H=27 CH32	41036367 41031725	
4	728655	Cuscinetto interno ed esterno mozzo / <i>Hub bearing</i>	ø 85x150 x38,5	109.14-115.17-135.14-135.17-145.17 TURBOSTAR 190.30/38 220.36PT/.38PT 190.33/.36/.42/.48-240.36/.48 TURBOTECH 190.24/.26/.30 240.26 - 260.30 - 260.36/.48 E.CARGO-EUROTECH-EUROSTAR	1905172 7164544 VKHB2080
5	728657	Cuscinetto interno mozzo / <i>Hub bearing, inner</i>	ø 96x170 x46,5	145.17	7164543 VKHB2210
2 175.17 - 175.24R/ .24T					
6	729145	Colonna fissaggio ruota / <i>Wheel stud</i>	M22x1,5 L=101	7168465 42117453	
7	729029	Dado per colonna / <i>Wheel nut</i>	M22x1,5	41800483	
8	726535	Rondella conica per colonna / <i>Cone washer</i>		3420371	
9	729046	Rondella spaccata per colonna / <i>Lockwasher</i>		504023611 1121811	
3 682N3/ N4 - 684NP - 619N1 - 160NC - 160.26 - 170/190NC26/ NC33/ NT33 170NC35 - 170/190F26/ F35 - 180NC GRUPPO DIFFERENZIALE / DIFFERENTIAL GROUP					
10	729502	Dado per pignone conico / <i>Pinion nut</i>	M50x1,5	682N3/ N4 U.T. - 170/190 160.26	4689843
11	715003	Manicotto per pignone conico / <i>Pinion driving flange</i>			4619754
MOZZI POSTERIORI / REAR HUBS					
12	728821	Bullone raggiera con dado / <i>Wheel stud</i>	M18x2,5 L=105	865558	
13	728822	Bullone raggiera con dado / <i>Wheel stud</i>	M18x2,5 L=125	-	
14	728751	Dado per bullone raggiera / <i>Wheel nut</i>	M18x2,5	865559	
15	730708	Paraolio interno mozzo / <i>Oil seal, inner</i>	ø 200x180x15	40000691	
16	730674	Paraolio esterno mozzo / <i>Oil seal, outer</i>	ø 168x150x13	40000950 4573796	
17	728905	Tassello fissaggio ruota / <i>Wheel pad</i>		619N1 - 684NP - 160NC 170/190 - 160.26	743587
4 697N/NP - 300PC GRUPPO DIFFERENZIALE / DIFFERENTIAL GROUP					
18	729511	Dado fiss. forcella sul pignone 1°-2° differenziale / <i>Mainshaft nut</i>	M40x1,5	697N/NP - 300PC	4608818
MOZZI POSTERIORI E INTERMEDI / MIDDLE AND REAR AXLE					
19	728821	Bullone raggiera con dado / <i>Wheel stud</i>	M18x2,5 L=105	865558	
20	728822	Bullone raggiera con dado / <i>Wheel stud</i>	M18x2,5 L=125	-	
21	728751	Dado per bullone raggiera / <i>Wheel nut</i>	M18x2,5	865559	
22	730708	Paraolio interno mozzo / <i>Oil seal, inner</i>	ø 200x180x15	40000691	
23	728905	Tassello fissaggio ruota / <i>Wheel pad</i>			743587

**PONTE POST.
REAR AXLE**

1

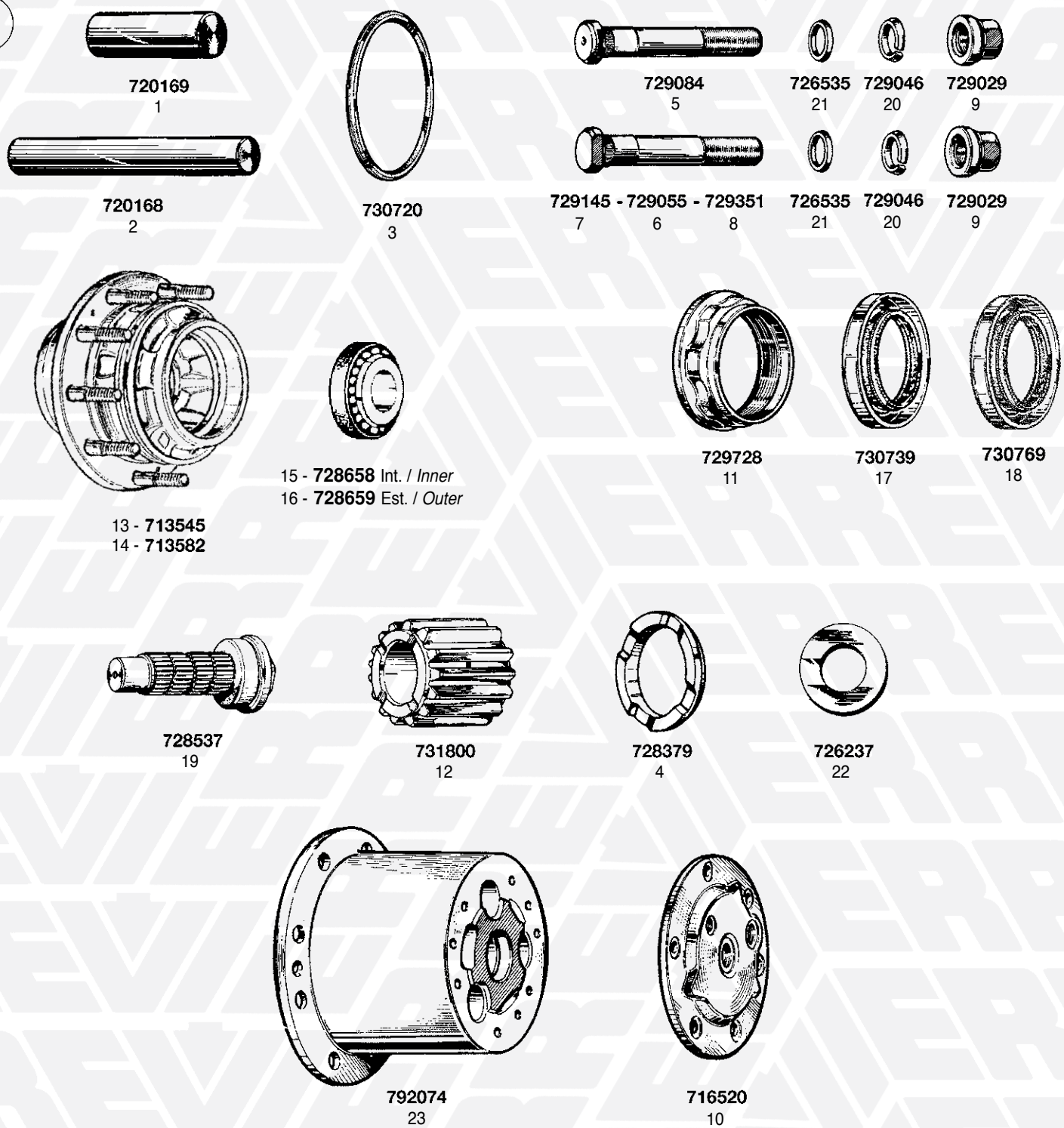

2

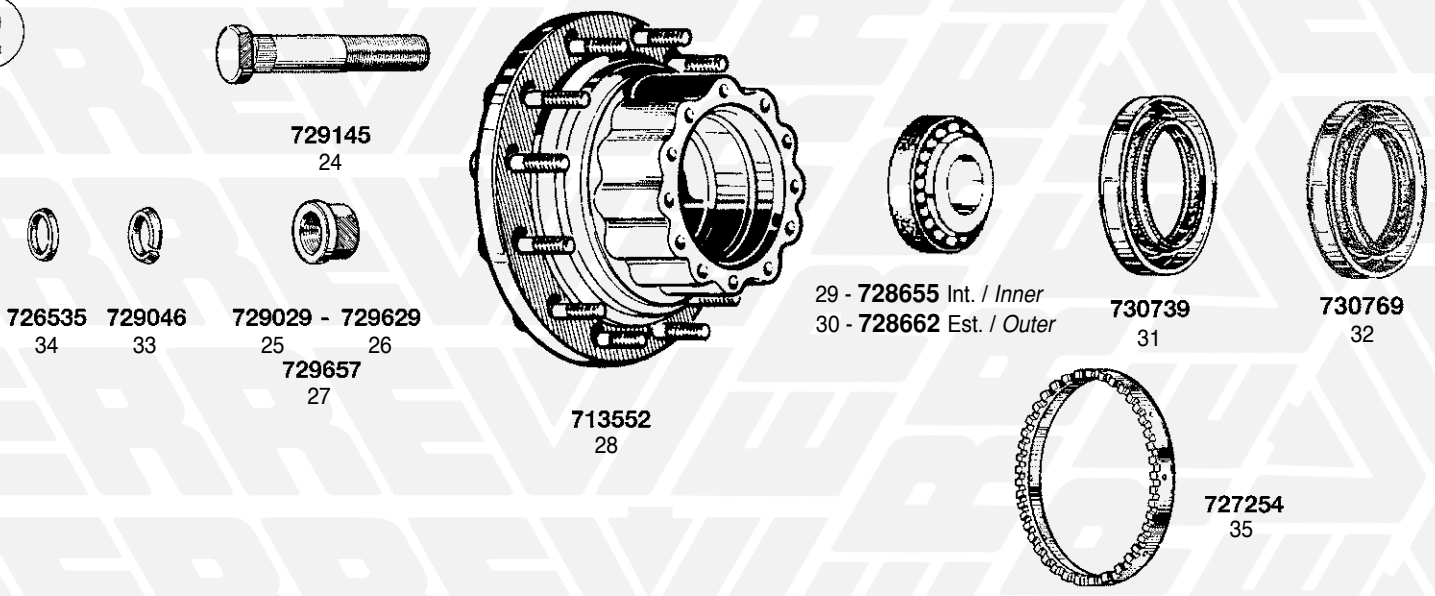

FIG. ITEM	RIF. ERREVI ERREVI REF.	DESCRIZIONE PARTICOLARI DESCRIPTION	TIPO VEHICLE MODEL	RIF. ORIG. ORIG. REF.
1 180.24/ .26 - 190i26/ i35 - 190.30/ .38 - 220.38PT - 240.30P/ .38P GRUPPO DIFFERENZIALE / DIFFERENTIAL GROUP				
1	720169	Perno portasatellite corto / <i>Pinion spindle</i>	∅ 27x177	42063134
2	720168	Perno portasatellite lungo / <i>Pinion spindle</i>		42063135
MOZZI POSTERIORI / REAR HUBS				
3	730720	Anello di tenuta per mozzo / <i>Oil seal</i>		42061628 42037594
4	728379	Anello rasamento satellite / <i>Thrust washer</i>		42037800
5	729084	Colonna fissaggio ruota 1ª Serie / <i>Wheel stud</i>	M22x1,5 L=110	2477764
6	729055	Colonna fissaggio ruota 2ª Serie / <i>Wheel stud</i>	M22x1,5 L=111	42064826 42061641 42101367 2475869 42117455
7	729145	Colonna fissaggio ruota U.T. / <i>Wheel stud</i>	M22x1,5 L=101	42127220 42117453
8	729351	Colonna fiss. ruota (cerchi in lega) / <i>Wheel stud (Alloy rims)</i>	M22x1,5 L=128,5	-
9	729029	Dado per colonna fissaggio ruota / <i>Wheel nut</i>	M22x1,5	41800483
10	716520	Coperchio per scatola riduttore / <i>Cover</i>		42062798 2476601
11	729728	Dado bloccaggio mozzo / <i>Nut</i>	M82x1,5	3555488
12	731800	Ingranaggio satellite riduttore / <i>Step-down gear</i>		42159023 4459829
13	713545	Mozzo ruota completo di colonnette U.T. / <i>Rear hub</i>		42101959 42037491
14	713582	Mozzo ruota completo di colonnette U.T. / <i>Wheel hub c/w studs</i>		42101361
15	728658	Cuscinetto interno mozzo (VKHB2215) <i>Hub bearing, inner</i>	∅ 105x190x41,3	1102864 26800090
16	728659	Cuscinetto esterno mozzo / <i>Hub bearing, outer (VKHB2216)</i>	∅ 120x180x38	1103360
17	730739	Paraolio esterno mozzo / <i>Oil seal, outer</i>	∅ 200x180x12	40003720
18	730769	Paraolio esterno mozzo in VITON / <i>Oil seal, outer (VITON material)</i>	∅ 200x180x12	40100673
19	728537	Perno portasatellite / <i>Saddle pin</i>		2477919
20	729046	Rondella spaccata per colonna / <i>Lockwasher</i>		504023611 1121811
21	726535	Rondella conica per colonna / <i>Cone washer</i>		3420371
22	726237	Rondella rasamento satellite / <i>Thrust washer</i>	∅ 29x51x1,3	2443705
23	792074	Scatola riduttore U.T. / <i>Transfer case housing</i>		42037489
2 TURBOSTAR 190.30 U.T./ .38 U.T. - 220.36PT U.T./ .38PT U.T. 190.33/ .36/ .42/ .48 - 240.36/ .48 - 260.36/ .48 TURBOTECH 190.24/ .26/ .30 - 240.26 - 260.3				
24	729145	Colonna fiss. ruota / <i>Wheel stud</i>	M22x1,5 L=101	7168465 42026222
25	729029	Dado per colonna / <i>Wheel nut</i>	M22x1,5 H=22	41800483
26	729629	Dado per colonna 1ª Serie / <i>Wheel nut</i>	M22x1,5 H=31	TURBOTECH 4459603
27	729657	Dado per colonna U.T. / <i>Wheel nut</i>	M22x1,5 H=27	TURBOTECH 41036367 41031725
28	713552	Mozzo ruota completo di colonnette (senza ruota fonica e parapolvere) / <i>Wheel hub c/w studs</i>		7168464 7168589
29	728655	Cuscinetto interno ed esterno mozzo (VKHB2080) <i>Hub bearing</i>	∅ 85x150x38,5	1905172 7164544
30	728662	Cuscinetto interno mozzo (VKHB221) <i>Hub bearing, inner</i>	∅ 105x190x53	7177004 26800270
31	730739	Paraolio esterno mozzo / <i>Oil seal, outer</i>	∅ 200x180x12	40003720
32	730769	Paraolio esterno mozzo in VITON / <i>Oil seal, outer (VITON material)</i>	∅ 200x180x12	40100673
33	729046	Rondella spaccata per colonna / <i>Lockwasher</i>		504023611 1121811
34	726535	Rondella conica per colonna / <i>Cone washer</i>		3420371
35	727254	Ruota fonica / <i>Impulse wheel</i>	∅ 202x218x24	190.30H - 330.30H/.36H 7166885

1



720169
1



720168
2

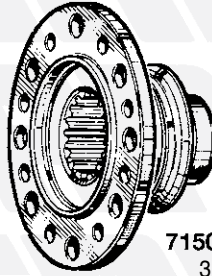

715008
3

2



728826
4



729027
5



728907
7

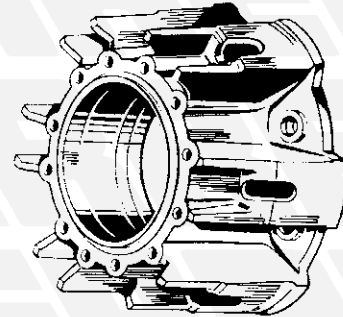

791026
6

3



729055
10



726535
25



729046
24



729029
13

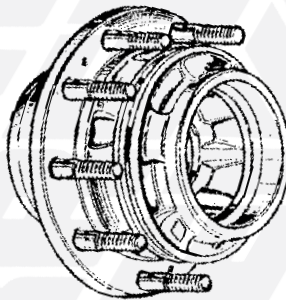

17 - 713545
18 - 713582



19 - 728658
Int. / Inner
20 - 728659
Est. / Outer



730739
21

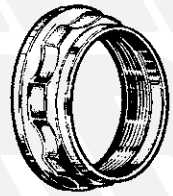

729728
15



729145 - 729351
11 12



726535
25



729046
24



729029
13

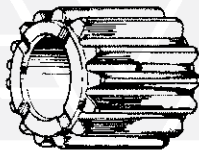

16 - 731800



728537
23



728379
9

726237
26



730720
8



730769
22

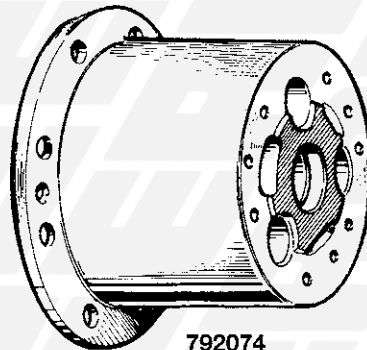

792074
27

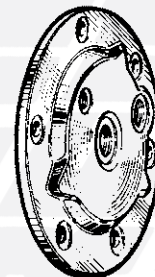

716520
14

FIG. ITEM	RIF. ERREVI ERREVI REF.	DESCRIZIONE PARTICOLARI DESCRIPTION	TIPO VEHICLE MODEL	RIF. ORIG. ORIG. REF.
1 330F26/ .26 - 330.30 - 330F35/ .35 - 330.36 GRUPPO DIFFERENZIALE / DIFFERENTIAL GROUP				
1	720169	Perno portasatellite corto / <i>Pinion spindle</i>	∅ 27x75	42063134
2	720168	Perno portasatellite lungo / <i>Pinion spindle</i>	∅ 27x177	42063135
3	715008	Manicotto pignone (ponte intermedio) / <i>Pinion sleeve (middle axle)</i>	330.26/ .30/ .35	42494048
2 MOZZI POSTERIORI CON RIDUTTORE (VEICOLI CON RAGGIERA) REAR AXLE EQUIPPED WITH TRANSFER CASE (VEHICLES WITH SPOKE WHEELS)				
4	728826	Bullone raggiera / <i>Wheel stud</i>	M20x2 L=115	42026106
5	729027	Dado per bullone raggiera / <i>Wheel nut</i>	M20x2	2478508
6	791026	Raggiera ruota / <i>Spoke wheel</i>		42037519 42026044
7	728907	Tassello fissaggio ruota / <i>Wheel pad</i>		42014566
3 MOZZI POSTERIORI CON RIDUTTORE (VEICOLI CON MOZZO) REAR AXLE EQUIPPED WITH TRANSFER CASE (VEHICLES WITH HUBS)				
8	730720	Anello di tenuta per mozzo / <i>Oil seal</i>		42061628 42037594
9	728379	Anello rasamento satellite / <i>Thrust washer</i>		42037800
10	729055	Colonna fiss. ruota 1ª Serie / <i>Wheel stud</i>	M22x1,5 L=111	42064826 42061641 42101367 42064826 42117455
11	729145	Colonna fiss. ruota U.T. / <i>Wheel stud</i>	M22x1,5 L=101	42127220 42117453
12	729351	Colonna fiss. ruota (cerchi in lega) / <i>Wheel stud (Alloy rims)</i>	M22x1,5 L=128,5	-
13	729029	Dado per colonna fissaggio ruota / <i>Wheel nut</i>	M22x1,5	41800483
14	716520	Coperchio per scatola riduttore / <i>Cover</i>		42062798 2476601
15	729728	Dado bloccaggio mozzo / <i>Nut</i>	M82x1,5	3555488
16	731800	Ingranaggio satellite riduttore / <i>Step-down gear</i>		42159023 4459829
17	713545	Mozzo ruota completa di colonnette U.T. / <i>Rear hub</i>		42101959 42037491
18	713582	Mozzo ruota completa di colonnette U.T. / <i>Wheel hub c/w studs</i>		42101361
19	728658	Cuscinetto interno mozzo / <i>Hub bearing, inner</i>	∅ 105x190x41,3	1102864 26800090 VKHB2215
20	728659	Cuscinetto esterno mozzo / <i>Hub bearing, outer</i>	∅ 120x180x38	1103360 VKHB2216
21	730739	Paraolio esterno mozzo / <i>Oil seal, outer</i>	∅ 200x180x12	42037581
22	730769	Paraolio esterno mozzo in VITON / <i>Oil seal, outer (VITON material)</i>	∅ 200x180x12	40100673
23	728537	Perno portasatellite / <i>Saddle pin</i>		2477919
24	729046	Rondella spaccata per colonna / <i>Lockwasher</i>		504023611 1121811
25	726535	Rondella conica per colonna / <i>Cone washer</i>		3420371
26	726237	Rondella rasamento satellite / <i>Thrust washer</i>	∅ 29x51x1,3	2443705
27	792074	Scatola riduttore U.T. / <i>Transfer case housing</i>		42037489



729347
1



729626
2



3 - 729185
5 - 729348



729028
4 - 6



7 - 729187
8 - 729054



9 - 729629 CH 32 - H 31
10 - 729657 CH 32 - H 27



729349
11



12 - 729629 CH 32 - H 31
13 - 729657 CH 32 - H 27



14 - 729803
15 - 729692

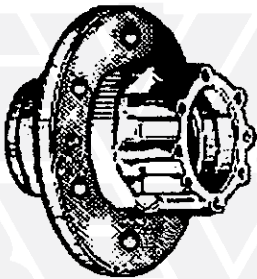

713625
18



728670
19

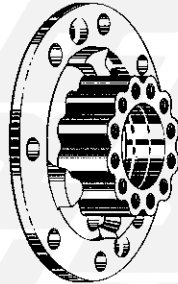

713630
20



728663
21

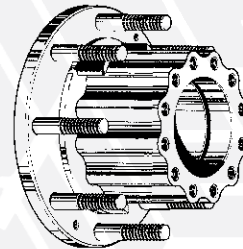

713637
22



23 - 728655
Int. / Inner
24 - 728656
Est. / Outer



728711
16



728737
17

NEW



730768
25



730765
26



727286
27

FIG. ITEM	RIF. ERREVI ERREVI REF.	DESCRIZIONE PARTICOLARI DESCRIPTION		TIPO VEHICLE MODEL	RIF. ORIG. ORIG. REF.
EUROCARGO					
1	729347	Colonna fiss. ruota / <i>Wheel stud</i>	M18x1,5 L=75	60E10/E12/E14 - 65E10/E12/E14 75E12/E14/E15	42117465 7168333
2	729626	Dado per colonna / <i>Wheel nut</i>	M18x1,5	60E10/E12/E14 - 65E10/E12/E14 75E12/E14/E15	4459602 93805743 99474404
3	729185	Colonna fiss. ruota / <i>Wheel stud</i>	M20x1,5 L=77	80E15/E18/E21 - 100E15/E18/E21 120EL5/EL18/EL21 - 180E21T	42064829 7170510 42117435 42117434
4	729028	Dado per colonna / <i>Wheel nut</i>	M20x1,5	80E15/E18/E21 - 100E15/E18/E21 120EL5/EL18/EL21 - 180E21T	2476979 4803810 99474403
5	729348	Colonna fiss. ruota / <i>Wheel stud</i>	M20x1,5 L=90	120E15/E18/E23 130E15/E18/E23 - 260E23T	42117437 42064831
6	729028	Dado per colonna / <i>Wheel nut</i>	M20x1,5	120E15/E18/E23 130E15/E18/E23 - 260E23T	2476979 4803810
7	729187	Colonna fiss. ruota 1ª Serie / <i>Wheel stud</i>	M22x1,5 L=89	150E15/E18/E23/E27 280E23 - 320E27	42064822 7168333
8	729054	Colonna fiss. ruota U.T. / <i>Wheel stud</i>	M22x1,5 L=86	150E15/E18/E23/E27 280E23 - 320E27	42117451 42119444 42101338 2476077 7168580
9	729629	Dado per colonna 1ª Serie / <i>Wheel nut</i>	M22x1,5 H=31	150E15/E18/E23/E27 - 280E23 - 320E27	4459603
10	729657	Dado per colonna U.T. / <i>Wheel nut</i>	M22x1,5 H=27	150E15/E18/E23/E27 280E23 - 320E27	41036367 41031725
11	729349	Colonna fiss. ruota / <i>Wheel stud</i>	M22x1,5 L=120	170E15/E18/E23/E27	42117457 42117309
12	729629	Dado per colonna 1ª Serie / <i>Wheel nut</i>	M22x1,5 H=31	170E15/E18/E23/E27	4459603
13	729657	Dado per colonna U.T. / <i>Wheel nut</i>	M22x1,5 H=27	170E15/E18/E23/E27	41036367 41031725
14	729803	Dado con guida / <i>Wheel nut</i>	M22x1,5 H tot. 45 mm	170E15/E18/E23/E27	-
15	729692	Dado con guida / <i>Wheel nut</i>	M22x1,5 H tot. 62 mm	170E15/E18/E23/E27	41032669
16	728711	Kit cuscinetto completo / <i>Bearing assembly</i>	ø 78x130x90	120EL15/EL18/EL21	7182915 7181863 7192915
17	728737	Kit cuscinetto completo / <i>Bearing assembly</i>	ø 82x140x110	EUROCARGO 160E20 EUROFIRE 160E30	2994058 7184079 7184080 805011C
18	713625	Mozzo ruota nudo / <i>Wheel hub, bare</i>		60E10/E12/E14 - 65E10/E12/E14 75E12/E14/E15	7172993
19	728670	Cuscinetto interno ed esterno mozzo / <i>Hub bearing</i>	ø 77,8x121,5x25,2	TURBO DAILY 59.12 DAILY CNG 59.11	1905220 VKHB2209
20	713630	Mozzo ruota nudo / <i>Wheel hub, bare</i>		80E15/E15H/E18/E21 - 85E18 95E18 - 100E15/E18/E21 - 180E21	7173696
21	728663	Cuscinetto interno ed esterno mozzo / <i>Hub bearing</i>	ø 75x115x25	80E15/E15H/E18/E21 - 85E18 95E18 - 100E15/E18/E21 - 180E21	1905219 7173736 7173737 VKHB2282
22	713637	Mozzo ruota completo di colonnette / <i>Wheel hubc/w studs</i>		120E15/E15H/E18/E18H/E21H 120E23 - 130E15/E18/E23 150E18H - 170E15/E18/E23 - 260E23	7172551
23	728655	Cuscinetto interno ed esterno mozzo / <i>Hub bearing</i>	ø 85x150x38,5		1905172 7164544 VKHB2080
24	728656	Cuscinetto esterno mozzo / <i>Hub bearing, outer</i>	ø 75x120x31		7166346 VKHB2137
25	730768	Paraolio esterno mozzo in VITON / <i>Oil seal, outer (VITON material)</i>	ø 95x130x16		7185250 40102143
26	730765	Paraolio esterno mozzo in VITON / <i>Oil seal, outer (VITON material)</i>	ø 114x152x15	120E15/E15H/E18/E18H/E21H/E23 130E15/E18/E23 - 150E18 170E15/E18/E23 - 260E23	40102321
27	727286	Ruota fonica / <i>Impulse wheel</i>	ø 110x118x101,5	60E10/E12/E14 - 65E10/E12/E14 75E12/E14/E15	7172753

**PONTE POST.
REAR AXLE**



729347
1



729626
2

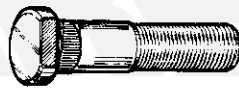

3 - 729185
5 - 729348



729028
4 - 6

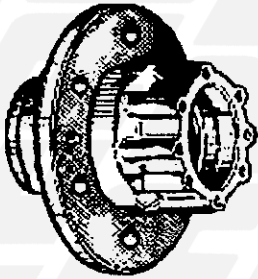

713625
7



728670
8

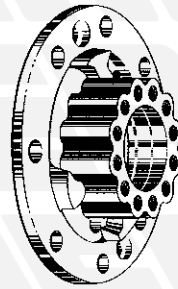

713630
9



728663
10

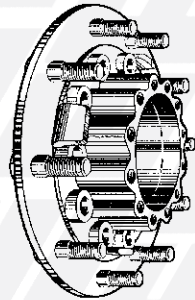

713631
11

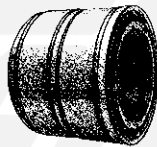

728710
12



730768
13

FIG. ITEM	RIF. ERREVI ERREVI REF.	DESCRIZIONE PARTICOLARI DESCRIPTION		TIPO VEHICLE MODEL	RIF. ORIG. ORIG. REF.
EUROCARGO "TECTOR"					
1	729347	Colonna fiss. ruota / <i>Wheel stud</i>	M18x1,5 L=75	75E13/E15/E17/E18	42117465 7168333
2	729626	Dado per colonna / <i>Wheel nut</i>	M18x1,5	75E13/E15/E17/E18	4459602
3	729185	Colonna fiss. ruota / <i>Wheel stud</i>	M20x1,5 L=77	100E17/E18/E21 - 120E17/E21	42064829 7170510 42117435 42117434
4	729028	Dado per colonna / <i>Wheel nut</i>	M20x1,5	100E17/E18/E21 - 120E17/E21	2476979 4803810 99474403
5	729348	Colonna fiss. ruota / <i>Wheel stud</i>	M20x1,5 L=90	100E18/E21 - 130E18/E24/E28	42064831 42117437
6	729028	Dado per colonna / <i>Wheel nut</i>	M20x1,5	100E18/E21 - 130E18/E24/E28	2476979 4803810
7	713625	Mozzo ruota nudo / <i>Wheel hub, bare</i>		75E13/E15/E17/E18	7172993
8	728670	Cuscinetto interno ed esterno mozzo / <i>Hub bearing</i>	∅ 77,8x121,5x25,2	TURBO DAILY 59.12 DAILY CNG 59.11	1905220 VKHB2209
9	713630	Mozzo ruota nudo / <i>Wheel hub, bare</i>		100E17/E18/E21	7173696
10	728663	Cuscinetto interno ed esterno mozzo / <i>Hub bearing</i>	∅75x115x25	EUROCARGO 80E15/E15H/E18/E21 85E18 - 95E18 100E15/E18/E21 - 180E21	1905219 7173736 7173737 VKHB2282
11	713631	Mozzo ruota completo di colonnette / <i>Wheel hubc/w studs</i>		180E21/E24/E28	7179777 7186804
12	728710	Kit cuscinetto completo / <i>Bearing assembly</i>	∅ 90x160x125		2996882 7179751 7183074 7189050
13	730768	Paraolio esterno mozzo in VITON / <i>Oil seal, outer (VITON material)</i>	∅95x130x16		7185250 40102143



729054
1



2 - 729629 CH 32 - H 31
3 - 729657 CH 32 - H 27



729349
4



729657
5



729728
11



729145
6



729657
7



8 - 729803
9 - 729692



728733
10

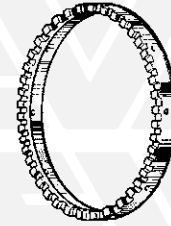

727254
21

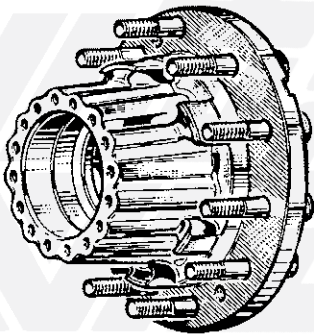

713596
12



13 - 728655 Est. / Outer
14 - 728662 Int. / Inner

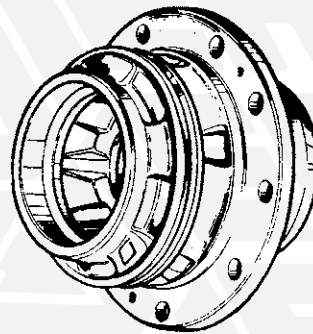

713508
15



16 - 728658 Int. / Inner
17 - 728659 Est. / Outer

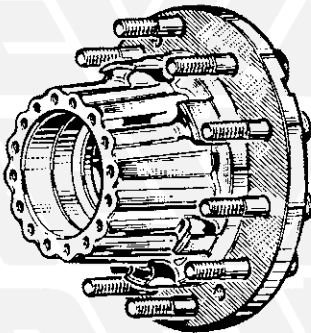

713518
18

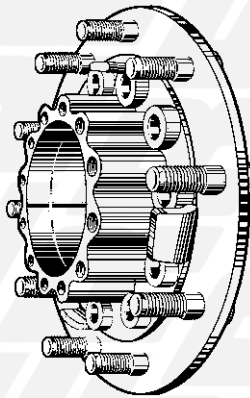

713631
20

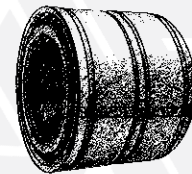

728710
19

FIG. ITEM	RIF. ERREVI ERREVI REF.	DESCRIZIONE PARTICOLARI DESCRIPTION		TIPO VEHICLE MODEL	RIF. ORIG. ORIG. REF.
EUROTECH - EUROTECH "CURSOR" EUROSTAR - EUROSTAR "CURSOR"					
1	729054	Colonna fiss. ruota / <i>Wheel stud</i>	M22x1,5 L=86	EUROTECH "CURSOR" EUROSTAR "CURSOR"	42117451 42119444 42101338 2476077 7168580
2	729629	Dado per colonna 1ª Serie / <i>Wheel nut</i>	M22x1,5 H=31	EUROTECH "Cursor"-EUROSTAR "Cursor"	4459603
3	729657	Dado per colonna U.T. / <i>Wheel nut</i>	M22x1,5 H=27	EUROTECH "CURSOR" EUROSTAR "CURSOR"	41036367 41299921 41031725
4	729349	Colonna fiss. ruota / <i>Wheel stud</i>	M22x1,5 L=120	EUROTECH - EUROSTAR 260E24/E31/E35/E39/E43 EUROTECH "CURSOR"	42117457 42117309
5	729657	Dado per colonna / <i>Wheel nut</i>	M22x1,5 H=27	EUROTECH -EUROSTAR 260E24/E31/E35/E39/E43 EUROTECH "CURSOR"	41036367 41299921 41031725
6	729145	Colonna fiss. ruota / <i>Wheel stud</i>	M22x1,5 L=101	EUROTECH-EUROSTAR 260E24/E31/E35/E39/E43 EUROTECH "CURSOR"	42064824 42117453
7	729657	Dado per colonna / <i>Wheel nut</i>	M22x1,5 H=27	EUROTECH -EUROSTAR 260E24/E31/E35/E39/E43 EUROTECH "CURSOR"	41036367 41299921 41031725
8	729803	Dado con guida / <i>Wheel nut</i>	M22x1,5 H tot. 45 mm		-
9	729692	Dado con guida / <i>Wheel nut</i>	M22x1,5 H tot. 62 mm		41032669 41036369
10	728733	Cuscinetto interno mozzo / <i>Hub bearing, inner</i>	ø 90x160x42,5	EUROTECH 240E38-400E38 EUROSTAR 180E38-240E38-400E38	1905353 7178975 26800240 32218A VKHB2030
11	729728	Dado bloccaggio mozzo / <i>Nut</i>	M82x1,5	190E42-440E42 EUROTECH 190E35-440E35/E39/E43 EUROTECH "CURSOR"	3555488
12	713596	Mozzo ruota completo di colonnette / <i>Wheel hub c/w studs (senza ruota fonica e parapolvere)</i>		EUROTECH - EUROSTAR	7179929 7181782 42551227
13	728655	Cuscinetto interno ed esterno mozzo / <i>Hub bearing</i>	ø 85x150x38,5		1905172 7164544 VKHB2080
14	728662	Cuscinetto interno mozzo / <i>Hub bearing, inner</i>	ø 105x190x53	EUROTECH - EUROSTAR	7177004 26800270 VKHB2212
15	713508	Mozzo ruota nudo / <i>Rear hub bare</i>		190E42-440E42 EUROTECH 190E35-440E35 EUROTECH "CURSOR"	42104691
16	728658	Cuscinetto interno mozzo / <i>Hub bearing, inner</i>	ø 105x190x41,3	EUROTECH 190E42 - 440E42 EUROTECH "Cursor" 190/440E35	1102864 26800090 VKHB2215
17	728659	Cuscinetto esterno mozzo / <i>Hub bearing, outer</i>	ø 120x180x38	EUROTECH 190E42 - 440E42 EUROTECH "Cursor" 190/440E35	1103360 VKHB2216
18	713518	Mozzo ruota completo di colonnette / <i>Wheel hubc/w studs</i>			7180909
19	728710	Kit cuscinetto completo / <i>Bearing assembly</i>	ø 90x160x125		2996882 7179751 7183074 7189050
20	713631	Mozzo ruota completo di colonnette / <i>Wheel hubc/w studs</i>		EUROTECH "Cursor" EUROSTAR "Cursor"	7179777 7186804
21	727254	Ruota fonica / <i>Impulse wheel</i>	ø 202x218x24	EUROTECH - EUROTECH "Cursor" EUROSTAR	7166885



729054
1



2 - 729629 CH 32 - H 31
3 - 729657 CH 32 - H 27



729055
4

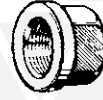

729657
5



726237
21



729351
6



7 - 729629 CH 32 - H 31
8 - 729657 CH 32 - H 27

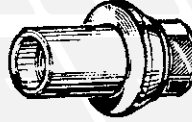

9 - 729803
10 - 729692



729728
12



727254
22

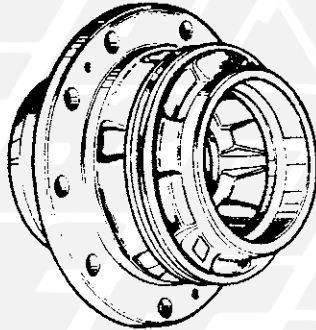

713508
15



16 - 728658 Int. / Inner
17 - 728659 Est. / Outer



730757
18

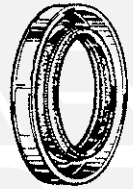

730739
19

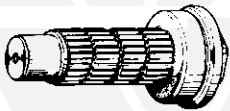

20 - 728544

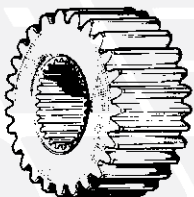

13 - 731851

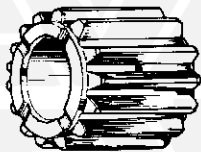

14 - 731850

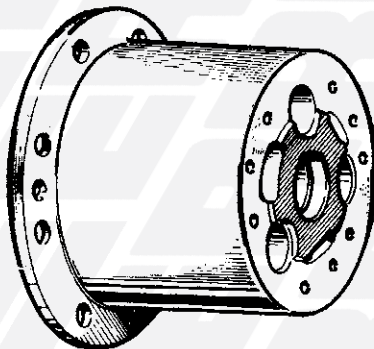

792076
23

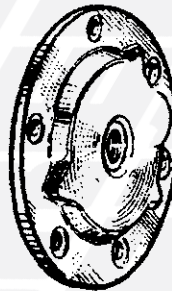

716521
11

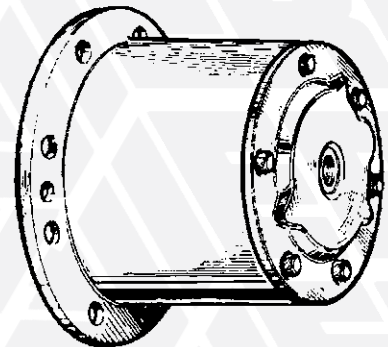

792077
24

FIG. ITEM	RIF. ERREVI ERREVI REF.	DESCRIZIONE PARTICOLARI DESCRIPTION		TIPO VEHICLE MODEL	RIF. ORIG. ORIG. REF.
EUROTRAKKER - EUROTRAKKER "CURSOR"					
1	729054	Colonna fiss. ruota / <i>Wheel stud</i>	M22x1,5 L=86	340E42-410E42 EUROTRAKKER EUROTRAKKER "CURSOR"	42117451 42119444 42101338 2476077 7168580
2	729629	Dado per colonna 1ª Serie / <i>Wheel nut</i>	M22x1,5 H=31	340E42-410E42 EUROTRAKKER EUROTRAKKER "CURSOR"	4459603
3	729657	Dado per colonna U.T. / <i>Wheel nut</i>	M22x1,5 H=27	340E42-410E42 EUROTRAKKER EUROTRAKKER "CURSOR"	41036367 41299921 41031725
4	729055	Colonna fiss. ruota / <i>Wheel stud</i>	M22x1,5 L=111	EUROTRAKKER 180E24/E27 EUROTRAKKER } 190E24/E27/E38 } "CURSOR"	42064826 42127249 42061641 42101367 42117455
5	729657	Dado per colonna / <i>Wheel nut</i>	M22x1,5 H=27	EUROTRAKKER 180E24/E27 EUROTRAKKER } 190E24/E27/E38 } "CURSOR"	41036367 41299921 41031725
6	729351	Colonna fiss. ruota (cerchi in lega) / <i>Wheel stud (Alloy rims)</i>	M22x1,5 L=128,5	EUROTRAKKER	-
7	729629	Dado per colonna 1ª Serie / <i>Wheel nut</i>	M22x1,5 H=31	EUROTRAKKER	4459603
8	729657	Dado per colonna / <i>Wheel nut</i>	M22x1,5 H=27	EUROTRAKKER	41036367 41031725
9	729803	Dado con guida / <i>Wheel nut</i>	M22x1,5 H TOT. 45	EUROTRAKKER "CURSOR"	-
10	729692	Dado con guida / <i>Wheel nut</i>	M22x1,5 H TOT. 62	EUROTRAKKER "CURSOR"	41036369
11	716521	Coperchio scatola riduttore / <i>Cover</i>			42118921
12	729728	Dado bloccaggio mozzo / <i>Nut</i>	M82x1,5		3555488
13	731851	Ingranaggio centrale riduttore / <i>Axle shaft gear</i>	Z=30		42064799
14	731850	Ingranaggio satellite riduttore / <i>Step-down gear</i>	Z=17		42064798
15	713508	Mozzo ruota nudo / <i>Rear hub bare</i>			42104691
16	728658	Cuscinetto interno mozzo / <i>Hub bearing, inner</i>	∅ 105x190x41,3		1102864 26800090 VKHB2215
17	728659	Cuscinetto esterno mozzo / <i>Hub bearing, outer</i>	∅ 120x180x38		1103360 VKHB2216
18	730757	Paraolio interno mozzo / <i>Oil seal, inner</i>	∅180x200x12	380E37 - 410E42 - 720E37/E42 EUROTRAKKER 190E31/E35 - 380E38/E48 } EUROTRAKKER 410E38/E44 - 720E38 } "CURSOR"	42127526 40100443
19	730739	Paraolio esterno mozzo / <i>Oil seal, outer</i>	∅ 200x180x12		42037581
20	728544	Perno portasatellite / <i>Saddle pin</i>			42064785
21	726237	Rondella rasamento satellite / <i>Thrust washer</i>	∅ 29x51x1,3		2443705
22	727254	Ruota fonica / <i>Impulse wheel</i>	∅ 202x218x24		7166885
23	792076	Scatola riduttore / <i>Transfer case housing</i>			42118227
24	792077	Scatola riduttore compl. di ingranaggi e coperchio / <i>Transfer case assy</i>			-

**PONTE POST.
REAR AXLE**



729054
1



2 - 729629 CH 32 - H 31
3 - 729657 CH 32 - H 27

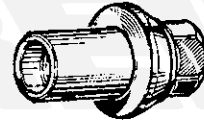

4 - 729803
5 - 729692



729177
6



7 - 729629 H 31
8 - 729657 H 27



729741
9

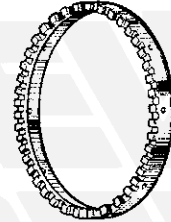

727254
13

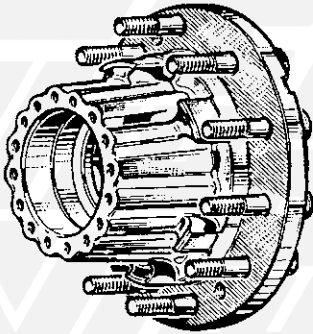

713518
10

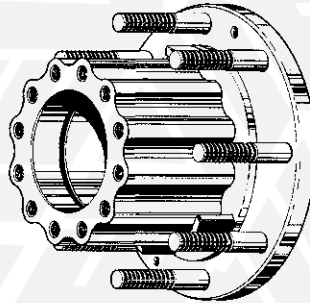

713631
12

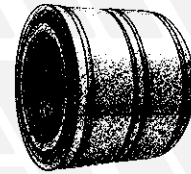

728710
11

FIG. ITEM	RIF. ERREVI ERREVI REF.	DESCRIZIONE PARTICOLARI DESCRIPTION		TIPO VEHICLE MODEL	RIF. ORIG. ORIG. REF.
STRALIS					
1	729054	Colonna fiss. ruota / <i>Wheel stud</i>	M22x1,5 L=86	260S40/S43	42117451 42119444 42101338 2476077 7168580
2	729629	Dado per colonna 1ª Serie / <i>Wheel nut</i>	M22x1,5 H=31	260S40/S43	4459603
3	729657	Dado per colonna / <i>Wheel nut</i>	M22x1,5 H=27	260S40/S43	41036367 41299921 41031725
4	729803	Dado con guida / <i>Wheel nut</i>	M22x1,5 H tot. 45	190S43/S48- 260S40/S43/S48/ S54 - 440S40/S43/S48/S54	-
5	729692	Dado con guida / <i>Wheel nut</i>	M22x1,5 H tot. 62	190S43/S48 - 260S40/S43/S48/S54 440S40/S43/S48/S54	41036369
6	729177	Colonna fiss. ruota / <i>Wheel stud</i>	M22x1,5 L=77	260S40/S43/S44/S48/S54 440S40/S43/S44/S48/S54	42117448 42116737 42064821
7	729629	Dado per colonna / <i>Wheel nut</i>	M22x1,5 H=31	260S40/S43/S44/S48/S54 440S40/S43/S44/S48/S54	4459603
8	729657	Dado per colonna / <i>Wheel nut</i>	M22x1,5 H=27	260S40/S43/S44/S48/S54 440S40/S43/S44/S48/S54	41036367 41299921 41031725
9	729741	Dado bloccaggio mozzo / <i>Wheel nut</i>	M88x2	190S36 - 260S36 - 440S45/S50	7184036 7179746
10	713518	Mozzo ruota completo di colonne / <i>Wheel hubc/w studs</i>			7180909
11	728710	Kit cuscinetto completo / <i>Bearing assembly</i>	ø 90x160x125		2996882 7179751 7183074 7189050
12	713631	Mozzo ruota completo di colonne / <i>Wheel hub c/w studs</i>			7179777 7186804
13	727254	Ruota fonica / <i>Impulse wheel</i>	ø 202x218x24		7166885

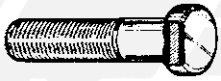

729389
4



729390
5

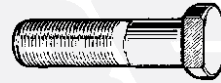

729391
6

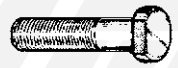

729392
7



729029
2



729046
3



729182
1



729830
9



729831
8



729832
10



729785
11



729786
12



729777
15



729778
16

FIG. ITEM	RIF. ERREVI ERREVI REF.	DESCRIZIONE PARTICOLARI DESCRIPTION		TIPO VEHICLE MODEL	RIF. ORIG. ORIG. REF.
MAN					
1	729182	Colonna fissaggio ruota / <i>Wheel stud</i>	M22x1,5 L=110	F2000 - F90	81455010067 81455010082 81455010141
2	729029	Dado per colonna / <i>Wheel nut</i>	M22x1,5		-
3	729046	Rondella spaccata per colonna / <i>Lockwasher</i>			-
4	729389	Colonna fissaggio ruota / <i>Wheel stud</i>	M18x1,5 L=58	TGL	81455010152 81455010116
5	729390	Colonna fissaggio ruota / <i>Wheel stud</i>	M18x1,5 L=70	TGL	81455010171
6	729391	Colonna fissaggio ruota / <i>Wheel stud</i>	M18x1,5 L=70	L2000	81455010181
7	729392	Colonna fissaggio ruota / <i>Wheel stud</i>	M18x1,5 L=70	L2000	81455010159
8	729831	Colonna fissaggio ruota / <i>Wheel stud</i>	M22x1,5 L=65	E2000 - F2000 - M2000 TGA TGM - TGS - TGX	81455010129
9	729830	Colonna fissaggio ruota / <i>Wheel stud</i>	M22x1,5 L=80	L2000 - M2000 - TGA - TGM TGS - TGX	81455010114 81455010133 81455010163 81455010164 81455010174
10	729832	Colonna fissaggio ruota / <i>Wheel stud</i>	M22x1,5 L=110	F2000 - TGA - TGM - TGS - TGX	81455010176 81455010131
11	729785	Dado di fiss. manicotto pignone conico / <i>Pinion nut</i>	M45x1,5	F90 - G90 - M90 TGM - TGL - TGX - TGA - TGS	81906400032 81906850311
12	729786	Dado di fiss. manicotto pignone conico / <i>Pinion nut</i>	M55x1,5	F90 - G90 - M90 TGM - TGL - TGX - TGA - TGS	81906850303 81906850052
13	729777	Ghiera fissaggio mozzo / <i>Axle locking nut</i>	M100x1,5 L=17	TGA	81906200092
14	729778	Ghiera fissaggio mozzo / <i>Axle locking nut</i>	M42x1,5 L=18	TGL	81906200098

**PONTE POST.
REAR AXLE**

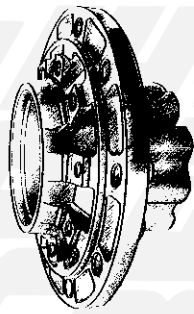

1 - 713782 Nudo / Bare
2 - 713796 Compl. / Assembly



728709
3

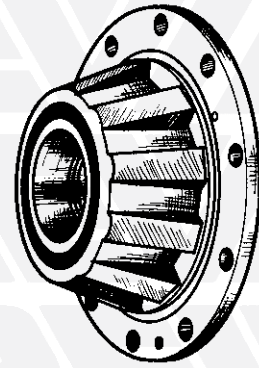

713916
4



5 - 728721
6 - 728722
7 - 728727
8 - 728728
9 - 728729
10 - 728735
11 - 728636

NEW



728720
12

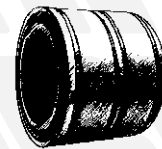

728711
13



730774
14



730785
15



730786
16

NEW

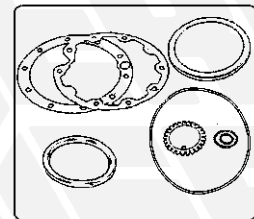

730795
17

NEW



727292
18

NEW

FIG. ITEM	RIF. ERREVI ERREVI REF.	DESCRIZIONE PARTICOLARI DESCRIPTION		TIPO VEHICLE MODEL	RIF. ORIG. ORIG. REF.
1	713782	Mozzo ruota, nudo / <i>Wheel hub, bare</i>		TGM - TGX - TGA - TGS (per freni a disco) (<i>for brake discs</i>)	81357010155
2	713796	Mozzo ruota completo / <i>Wheel hub assembly</i>		TGM - TGX - TGA - TGS (per freni a disco) (<i>for brake discs</i>)	813570101555
3	728709	Kit cuscinetto completo / <i>Bearing assembly</i>	ø 105x160x140	TGM - TGX - TGA - TGS	81934200342 81934200320 81934200376
4	713916	Mozzo ruota completo / <i>Wheel hub assembly</i>		TGA - TGS - TGX	81357006150 81357006136
5	728721	Cuscinetto esterno mozzo / <i>Hub bearing, outer</i>	ø 100x180x37	F90 - E2000 - F2000 - M2000 TGA	06324890032 06324890095 64934200023 64934200024 64934200065 81934200090 30220A VKHB2164
6	728722	Cuscinetto interno ed esterno mozzo / <i>Hub bearing</i>	ø 90x140x32	L2000 - M2000 - M90	06324890011 06324890051 32018XA VKHB2170
7	728727	Cuscinetto interno mozzo / <i>Hub bearing, inner</i>	ø 105x160x43	TGA - TGS - TGX	06324990096 06324990127 06324990183 06324990188 33021 VKHB2162
8	728728	Cuscinetto interno mozzo / <i>Hub bearing, inner</i>	ø 110x170x47	F2000 - M2000 - F90 - M90 E2000 - TGA - TGM - TGX	06324990044 06324990045 06324990155 06324990156 33022 VKHB2163
9	728729	Cuscinetto esterno mozzo / <i>Hub bearing, outer</i>	ø 75x125x37	L2000 - M2000 - M90 - E2000 F2000 - F90 - TGA	06324990040 06324990131 06324990189 81934200270 33115 VKHB2222
10	728735	Cuscinetto interno mozzo / <i>Hub bearing, inner</i>	ø 100x150x39	E2000	06324990124 06324990125 81934200304 33020
11	728636	Cuscinetto esterno mozzo / <i>Outer bearing</i>	ø 80x130x37		06324906400 33116
12	728720	Kit cuscinetto completo / <i>Bearing assembly</i>	ø 110x170x146	F2000-TGA-TGS-TGX	81934200346 81934200377 81934206098
13	728711	Kit cuscinetto completo / <i>Bearing assembly</i>	ø 78x130x90	L2000 - TGL - TGM	81934200336 81934200379 81934206083 81934206099
14	730774	Paraolio mozzo con ABS / <i>Oil seal c/w ABS</i>	ø 135x175x16	F90 - F2000	81965030188 81965030398 81965030207
15	730785	Paraolio interno mozzo / <i>Oil seal, inner</i>	ø 144x175x14	TGA - TGS - TGX - F2000 M90 - L2000 - F90 - G90 - M2000	06562890371
16	730786	Paraolio interno mozzo / <i>Oil seal, inner</i>	ø 132x172x12	TGA - TGM - TGS - TGX	81965030333 81965030399
17	730795	Kit paraolio mozzo posteriore / <i>Oil seal repai kit</i>		F90 - M90 - F2000 - L2000 M2000 - TGA	81908010224
18	727292	Ruota fonica / <i>Impulse wheel</i>	ø 114x160x27,5 80 denti / <i>teeth</i>	L2000 - TGL	81524006005 81524030029 81930210397

**PONTE POST.
REAR AXLE**

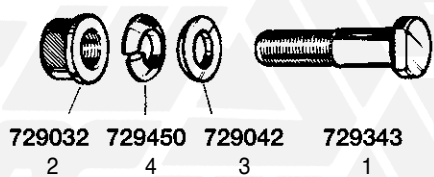

729659
12



8 - 729374 L=68
9 - 729369 L=80
10 - 729364 L=90
11 - 729375 L=110

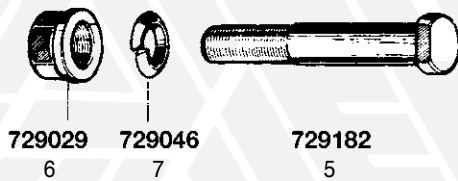

13 - 728721
14 - 728722
15 - 728723
16 - 728724
17 - 728727
18 - 728728
19 - 728729
20 - 728733

FIG. ITEM	RIF. ERREVI ERREVI REF.	DESCRIZIONE PARTICOLARI DESCRIPTION		TIPO VEHICLE MODEL	RIF. ORIG. ORIG. REF.
MERCEDES					
1	729343	Colonna fissaggio ruota / <i>Wheel stud</i>	M20x1,5 L=72	811 - 813 - 913 - 1113 - 1213	3524020171 3124021071
2	729032	Dado per colonna / <i>Wheel nut</i>	M20x1,5	811 - 813 - 913 - 1113 - 1213	74361020205 074361020204
3	729042	Rondella conica per colonna / <i>Cone washer</i>		811 - 813 - 913 - 1113 - 1213	664020075
4	729450	Rondella spaccata per colonna / <i>Lockwasher</i>		811 - 813 - 913 - 1113 - 1213	74361020352
5	729182	Colonna fissaggio ruota / <i>Wheel stud</i>	M22x1,5 L=110	1222-1622-1932-2626-3250-3535	3464010071 3814010771
6	729029	Dado per colonna / <i>Wheel nut</i>	M22x1,5	1222-1622-1932-2626-3250-3535	3854000124 6174000024
7	729046	Rondella spaccata per colonna / <i>Lockwasher</i>		1222-1622-1932-2626-3250-3535	74361022351
8	729374	Colonna fissaggio ruota / <i>Wheel stud</i>	M22x1.5 L=68	ACTROS - ATEGO	9424010271
9	729369	Colonna fissaggio ruote / <i>Wheel stud</i>	M22x1.5 L=80	ATEGO - ACTROS	-
10	729364	Colonna fissaggio ruota / <i>Wheel stud</i>	M22x1.5 L=90	ACTROS - ATEGO	9424010371
11	729375	Colonna fissaggio ruota / <i>Wheel stud</i>	M22x1,5 L=110	ACTROS - ATEGO	3814010771
12	729659	Dado per colonna / <i>Wheel nut</i>	M22x1,5	ACTROS - ATEGO	0004010672
13	728721	Cuscinetto esterno mozzo / <i>Hub bearing, outer</i>	ø 100x180x37	Serie MK - SK - NG	0049812105 0049814905 0079810005 30220A VKHB2164
14	728722	Cuscinetto mozzo / <i>Hub bearing</i>	ø 90x140x32	ATEGO - ATEGO2 - ATEGO3	0049811705 0049814305 0059815605 0069810005 32018XA VKHB2170
15	728723	Cuscinetto esterno mozzo / <i>Hub bearing, outer</i>	ø 95x145x32	Serie MK - SK - NG ACTROS - ACTROS MP2	0019802602 0029815405 0039815105 0069814705 32019XA VKHB2161
16	728724	Cuscinetto mozzo / <i>Hub bearing</i>	ø 100x150x32	ACTROS - ATEGO - AXOR - AXOR 2 ACTROS MP2	0019802602 0029815405 0039815105 0069814705 32019XA VKHB2161
17	728727	Cuscinetto interno mozzo / <i>Hub bearing, inner</i>	ø 105x160x43	ACTROS - ATEGO - AXOR - AXOR 2 ACTROS MP2	0009809702 0039812605 0039812805 0059814905 33021 VKHB2162
18	728728	Cuscinetto interno mozzo / <i>Hub bearing, inner</i>	ø 110x170x47	ACTROS - ATEGO - AXOR - AXOR 2 ACTROS MP2 - ACTROS MP4	0049810705 0049810905 0059812105 0089813505 0189817105 33022 VKHB2163
19	728729	Cuscinetto mozzo / <i>Hub bearing</i>	ø 75x125x37	ACTROS - ATEGO - AXOR - AXOR 2 ACTROS MP2	0009814218 0039813005 0039813205 0089810305 33115 VKHB2222
20	728733	Cuscinetto mozzo / <i>Hub bearing</i>	ø 90x160x42,5		000720032218 32218A VKHB2030

**PONTE POST.
REAR AXLE**



729785
1



729786
2

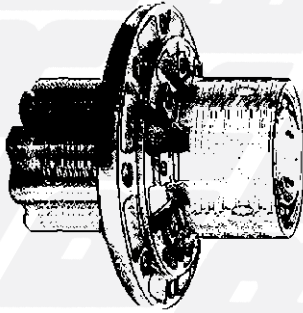

NEW 3 - 713948 Compl. / Assembly



NEW 4 - 713947 Nudo / Bare

5 - 728735 **NEW**
6 - 728636

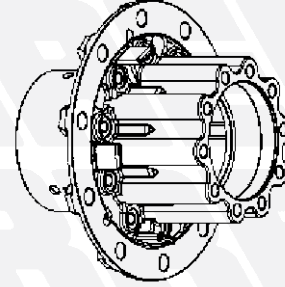

NEW 7 - 713949



730785
8

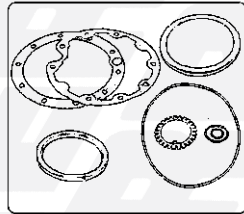

730795
9
NEW

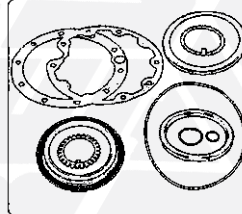

730796
10
NEW

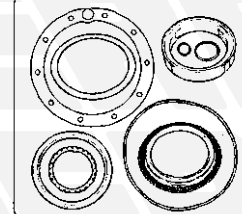

730797
11
NEW

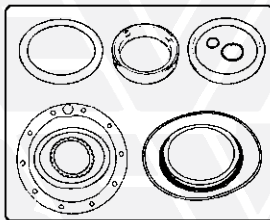

730798
12
NEW

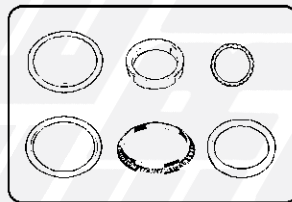

730799
13
NEW



727299
14
NEW



727267
15

FIG. ITEM	RIF. ERREVI ERREVI REF.	DESCRIZIONE PARTICOLARI DESCRIPTION		TIPO VEHICLE MODEL	RIF. ORIG. ORIG. REF.
1	729785	Dado di fiss. manicotto pignone conico / <i>Pinion nut</i>	M45x1,5	ACTROS	3663530072 3853510672
2	729786	Dado di fiss. manicotto pignone conico / <i>Pinion nut</i>	M55x1,5		3463530072 3853510572
3	713948	Mozzo ruota completo / <i>Wheel hub assembly</i>		ATEGO - ATEGO 2	9763560701S 9763561101S 9763561801S
4	713947	Mozzo ruota nudo / <i>Wheel hub, bare</i>		ATEGO - ATEGO 2	9763560701 9763561101 9763561801
5	728735	Cuscinetto interno mozzo / <i>Hub bearing, inner</i>	ø 100x150x39	ATEGO - ATEGO 2 - ATEGO 3 ACTROS ACTROS MP2 - ACTROS MP4	0019806602 0059818405 0059818505 0069810105 0149813205 33020
6	728636	Cuscinetto esterno mozzo / <i>Outer bearing</i>	ø 80x130x37	ATEGO - ATEGO 2 - ATEGO 3 ACTROS ACTROS MP2 - ACTROS MP4	0129814005 0129814105 0179814905 33116
7	713949	Mozzo ruota nudo / <i>Wheel hub bare</i>		ACTROS - ACTROS MP2 ACTROS MP3 AXOR	9463560701
8	730785	Paraolio interno mozzo / <i>Oil seal, inner</i>	ø 144x175x14	ACTROS - ACTROS MP2 - ATEGO	0159974947
9	730795	Kit paraolio mozzo posteriore / <i>Oil seal repai kit</i>		AXOR - AXOR 2 - ATEGO ACTROS - ACTROS MP2 ACTROS MP4	6243560080
10	730796	Kit paraolio mozzo posteriore / <i>Oil seal repair kit</i>		AXOR - AXOR 2 - ATEGO ACTROS - ACTROS MP2 Serie NG - SK - LK - LP - MK Series	6593500035 6593500135
11	730797	Kit paraolio mozzo posteriore / <i>Oil seal repair kit</i>		AXOR - AXOR 2 ATEGO - ATEGO 2 ACTROS - ACTROS MP2	9403500035
12	730798	Kit paraolio mozzo posteriore / <i>Oil seal repair kit</i>		AXOR - AXOR 2 - ATEGO ACTROS - ACTROS MP2 ACTROS MP4	9403500635 9403501735
13	730799	Kit paraolio mozzo posteriore / <i>Oil seal repair kit</i>		AXOR - AXOR 2 - ATEGO ACTROS - ACTROS MP2 ACTROS MP4	9403501035
14	727299	Ruota fonica / <i>Impulse wheel</i>	ø 127,5x131/162 80 denti / <i>teeth</i>	ATEGO	9703560615 A9703560615
15	727267	Ruota fonica / <i>Impulse wheel</i>	ø 153x176x16 100 denti/ <i>teeth</i>	ATEGO - AXOR - AXOR 2 - ACTROS ACTROS MP2	9423560715 9423560315 9423560015

**PONTE POST.
REAR AXLE**

1 NISSAN



729814
2

NEW



729394
1

2 RENAULT

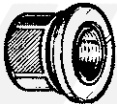

729624
7



729175
3



729387
6

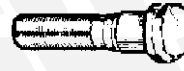

729393
4



729395
5



729773
8



726374
24



9 - 728723
10 - 728725
11 - 728727



730793
23
NEW

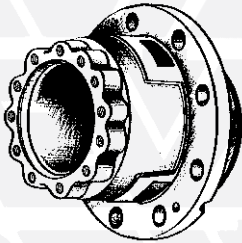

713780
12



13 - 728708 Est. / Outer
14 - 728707 Int. / Inner

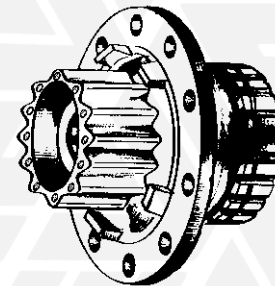

15 - 713917 Nudo / Bare
16 - 713776 Compl. / Assembly



728706
18

NEW 17 - 713919 Compl. FAG / FAG Assembly

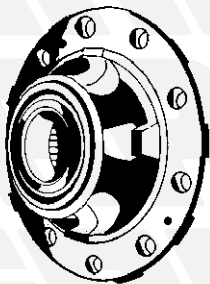

19 - 713901 Nudo / Bare
20 - 713902 Compl. / Assembly

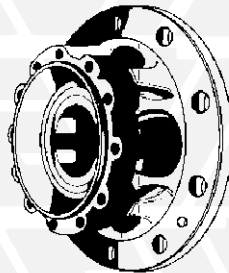

713799
21



728706
18

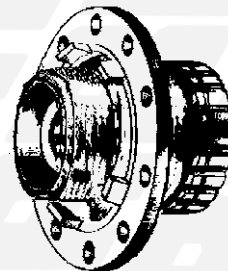

713944
22

NEW

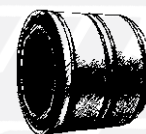

728706
18



727290
25

FIG. ITEM	RIF. ERREVI ERREVI REF.	DESCRIZIONE PARTICOLARI DESCRIPTION		TIPO VEHICLE MODEL	RIF. ORIG. ORIG. REF.
<div style="text-align: center;"> 1 NISSAN </div>					
1	729394	Colonna fissaggio ruota / <i>Wheel stud</i>	M16x1,5 L=59	CABSTAR 110-120	402229X50B 43222F3600
2	729814	Dado per colonna / <i>Wheel nut</i>	M16x1,5		402249X50A 402249X500
<div style="text-align: center;"> 2 RENAULT </div>					
3	729175	Colonna fissaggio ruota / <i>Wheel stud</i>	M22x1,5 L=95	Gamma G.R. (veicoli pesanti)	0000190220 5010097347 5010457733 7420551045
4	729393	Colonna fissaggio ruota / <i>Wheel stud</i>	M22x1,5 L=79	MAGNUM - PREMIUM	7420515514
5	729395	Colonna fissaggio ruota / <i>Wheel stud</i>	M22x1,5 L=105	MAGNUM - PREMIUM - KERAX	7420515519
6	729387	Colonna fissaggio ruota / <i>Wheel stud</i>	M22x1,5 L=114	MAGNUM - PREMIUM - KERAX	7420524942 7421147687
7	729624	Dado per colonna / <i>Wheel nut</i>	M22x1,5	Gamma G.R. (veicoli pesanti)	5010262935 5010439317 5010439406
8	729773	Ghiera fissaggio mozzo / <i>Axle locking nut</i>	M86x2	MAGNUM - PREMIUM	7401076335
9	728723	Cuscinetto interno mozzo / <i>Hub bearing, inner</i>	ø 95x145x32	KERAX - MAGNUM - MAXTER MIDLINER - MIDLUM - PREMIUM	5010241096 5010439224 5010534822 5010587011 32019XA VKHB2161
10	728725	Cuscinetto interno ed esterno mozzo / <i>Hub bearing</i>	ø 110x170x38	MIDLINER (6 x 6)	5001014916 5000021895 VKHB2281 32022X
11	728727	Cuscinetto interno mozzo / <i>Hub bearing, inner</i>	ø 105x160x43		5010319057 5010443791 5010443751 33021 VKHB2162
12	713780	Mozzo ruota, nudo / <i>Wheel hub, bare</i>		PREMIUM - MAGNUM - KERAX	5010566112
13	728708	Cuscinetto esterno mozzo / <i>Outer bearing</i>	ø 95x150x42	PREMIUM - MAGNUM - KERAX	5010587009
14	728707	Cuscinetto interno mozzo / <i>Inner bearing</i>	ø 95x160x46	PREMIUM - MAGNUM - KERAX	5010587010
15	713917	Mozzo ruota nudo / <i>Wheel hub, bare</i>		PREMIUM - MAGNUM	7420516957
16	713776	Mozzo ruota completo / <i>Wheel hub assembly</i>		MAGNUM - PREMIUM (per freno a disco) / (for brake disc)	7420535263 7485107753
17	713919	Mozzo ruota completo di cuscinetto FAG <i>Wheel hub assembly (complete with FAG bearing)</i>		PREMIUM - MAGNUM	7420535263 7485107753
18	728706	Kit cuscinetto completo / <i>Bearing assembly</i>	ø 94x148x135	KERAX - PREMIUM - PREMIUM 2 MAGNUM DXi	7420518661 7420792439 7421036050
19	713901	Mozzo ruota nudo / <i>Wheel hub, bare</i>		PREMIUM - KERAX	7421328181 7420820402
20	713902	Mozzo ruota completo / <i>Wheel hub assembly</i>		PREMIUM - KERAX	7421328181S 7420820402S
21	713799	Mozzo ruota completo / <i>Wheel hub assembly</i>		PREMIUM - KERAX	7420819822 7420820420
22	713944	Mozzo ruota completo / <i>Wheel hub assembly</i>			7485109244 7420819826
23	730793	Paraolio interno differenziale / <i>Oil seal, inner</i>	ø 76x131,5x20	Serie K Series	7401522895
24	726374	Rondella di bloccaggio dado assale / <i>Lock washer</i>		MAGNUM - PREMIUM	7408157714
25	727290	Ruota fonica / <i>Impulse wheel</i>	ø 140x164x7 100 denti / <i>teeth</i>	PREMIUM - MAGNUM - KERAX	7420424109



729047
6



729268
5



1 - 729162
2 - 729163



3 - 729397
4 - 729833

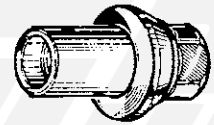

7 - 729808
8 - 729809
9 - 729810
10 - 729811

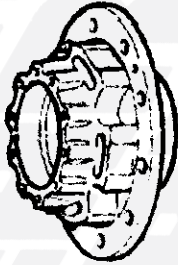

713753
20



728641
23



727296
27

NEW



11 - 728725
12 - 728726
13 - 728727
14 - 728731
15 - 728733
16 - 728636



729787
17

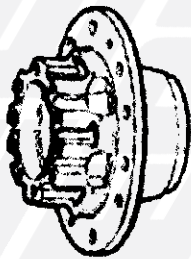

713751
21



728641
23



730771
24



730773
25



727268
26

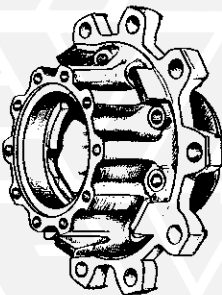

18 - 713774 nudo / bare
19 - 713798 completo / assembly



728641
23

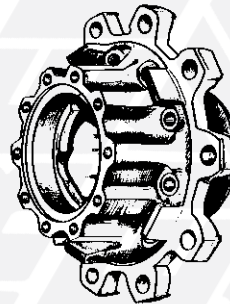

713794
22



728641
23

FIG. ITEM	RIF. ERREVI ERREVI REF.	DESCRIZIONE PARTICOLARI DESCRIPTION		TIPO VEHICLE MODEL	RIF. ORIG. ORIG. REF.
SCANIA					
1	729162	Colonna posteriore / <i>Wheel stud</i>	7/8"Dx L=85	81 - 86 - 110 - 111 - 112 - 141 142 - 143	295953 1368693
2	729163	Colonna posteriore / <i>Wheel stud</i>	7/8"Dx L=100	110 - 111 - 112 - 142 143 (4x2 - 6x2 - 6x4)	272853 1368694
3	729397	Colonna fissaggio ruota / <i>Wheel stud</i>	7/8"-11BSF L=85	Serie P - G - R - T Series 94 - 114 - 124	2285279 1528712
4	729833	Colonna fissaggio ruota / <i>Wheel stud</i>	7/8"-11BSF L=105	Serie P - G - R - T Series Serie 4 Series	1528655
5	729268	Dado / <i>Wheel nut</i>	7/8"Dx H=26		318690 1365510 1749034 243956
6	729047	Dado per bullone raggiera c/battuta / <i>Wheel nut</i> Ruote posteriori (veicoli con mozzi) / <i>Rear wheels (with spoke wheels)</i>	M18x2		265447 130961
7	729808	Dado con guida / <i>Wheel nut</i>	7/8"-11 BSF H 44		-
8	729809	Dado con guida / <i>Wheel nut</i>	7/8"-11 BSF H 50		-
9	729810	Dado con guida / <i>Wheel nut</i>	7/8"-11 BSF H 56		-
10	729811	Dado con guida / <i>Wheel nut</i>	7/8"-11 BSF H 78		-
11	728725	Cuscinetto esterno mozzo / <i>Hub bearing, outer</i>	ø 110x170x38	82 - 92 - 112 - 142 - 93 - 113 - 143	351715 264960 362226 32022X VKHB2281
12	728726	Cuscinetto esterno mozzo / <i>Hub bearing, outer</i>	ø 45x100x38,25	82 - 92 - 112 - 142 - 93 - 113 - 143	397314 1362149 014623 32309A VKHB2004
13	728727	Cuscinetto interno mozzo / <i>Hub bearing, inner</i>	ø 105x160x43	82 - 92 - 112 - 142 - 93 - 113 - 143	351713 33021 VKHB2162
14	728731	Cuscinetto interno ed esterno mozzo / <i>Hub bearing</i>	ø 100x157x42	82 - 92 - 112 - 142 93 - 113 - 143	354076 272716 KHM220149.220.110 VKHB2032
15	728733	Cuscinetto interno ed esterno mozzo / <i>Hub bearing</i>	ø 90x160x42,5	82 - 92 - 112 - 142 93 - 113 - 143	14835 32218A VKHB2030
16	728636	Cuscinetto esterno mozzo / <i>Outer bearing</i>	ø 80x130x37		1301694 33116
17	729787	Ghiera fissaggio mozzo / <i>Grooved nut</i>	M60x2	94 - 114 - 124 - 144	1356196 1403618 1873183
18	713774	Mozzo ruota nudo / <i>Wheel hub, bare</i>		94 - 114 - 124 - 144 - 164 (per freno a disco) / (for brake disc)	1724790
19	713798	Mozzo ruota completo / <i>Wheel hub assembly</i>		94 - 114 - 124 - 144 - 164 (per freno a disco) / (for brake disc)	17247905
20	713753	Mozzo ruota nudo / <i>Wheel hub, bare</i>		93 - 113 - 143 94 - 114 - 124 - 144 - 164	255348 337565 347945 1724788
21	713751	Mozzo ruota nudo / <i>Wheel hub, bare</i>		94 - 114 - 124 - 144 - 164 (per freno a disco) / (for brake disc)	1382884
22	713794	Mozzo ruota nudo / <i>Wheel hub, bare</i>		94 - 114 - 124 - 144 - 164	1800283
23	728641	Cuscinetto int./est. mozzo / <i>Hub bearing</i>	ø 90x147x42	93 - 113 - 143 - 94 - 114 - 124 - 144 - 164	1524625
24	730771	Paraolio mozzo / <i>Oil seal, rear</i>	ø 158x188x16	93 - 113 - 143 - 114 - 124 - 144	1309342 1363674 1528043 1786639 1907845 528043
25	730773	Paraolio mozzo / <i>Oil seal</i>	ø 143,5x170x20	93 - 113 - 143 - 114 - 124 - 144	291076 370076 120310
26	727268	Ruota fonica / <i>Impulse wheel</i>	ø 126x164x8,5 100 denti / <i>teeth</i>	Serie 3 - 4 Series	1339680 1375382
27	727296	Ruota fonica / <i>Impulse wheel</i>	ø 174x192x13 100 denti / <i>teeth</i>	94 - 114 - 124 - 144 - 164 Serie P - G - R - T Series	1790708 1788291

**PONTE POST.
REAR AXLE**

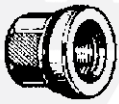

729624
4



1 - 729393 L=79
2 - 729395 L=105
3 - 729387 L=114

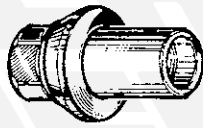

8 - 729804
9 - 729805
10 - 729806
11 - 729807

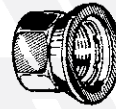

729258
7



5 - 729156
6 - 729198 con riduttore



729775
13



729773
14



726374
15

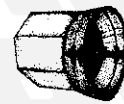

732741
12

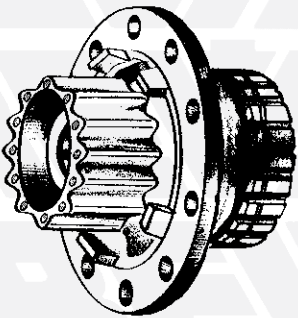

16 - 713917
Nudo / Bare

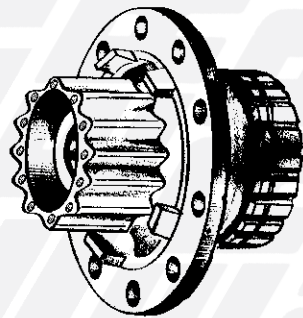

713777
19

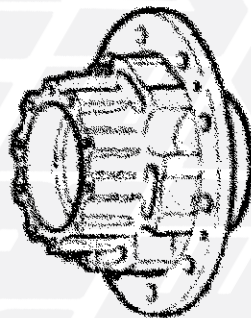

713778
20



728706
21



730760
22

17 - 713776
Compl. / Assembly

18 - 713919
Compl. FAG / FAG Assembly

NEW

FIG. ITEM	RIF. ERREVI ERREVI REF.	DESCRIZIONE PARTICOLARI DESCRIPTION		TIPO VEHICLE MODEL	RIF. ORIG. ORIG. REF.
VOLVO					
1	729393	Colonna fissaggio ruota / <i>Wheel stud</i>	M22x1,5 L=79	FH - FH12 - FH16 - FL6 - FM - FM12	20515514
2	729395	Colonna fissaggio ruota / <i>Wheel stud</i>	M22x1,5 L=105	B7 - B10 - B12 - FH - FM - FH12 FH16 - FM9 - FM12	20515519
3	729387	Colonna fissaggio ruota / <i>Wheel stud</i>	M22x1,5 L=114	FM9 - FM12 - FH12 - FH16	20524942 21147687
4	729624	Dado per colonna / <i>Wheel nut</i>	M22x1.5 H=31 Ch=33	FM9 - FM12 - FH12 - FH16	20551045 21303956 21402076
5	729156	Colonna fissaggio ruota / <i>Wheel stud</i>	7/8"Dx L=102	F7 - F10 - F12 - F16 - N7 - N10 - N12	1573082
6	729198	Colonna fissaggio ruota (con riduttore) / <i>Wheel stud</i>	7/8"Dx L=115	F16	1589009
7	729258	Dado per colonna / <i>Wheel nut</i>	7/8"Dx H=35	F7 - F10 - F12 - F16 N7 - N10 - N12	943491 1083894
8	729804	Dado con guida / <i>Wheel nut</i>	7/8"-14 UNF H tot. 44		-
9	729805	Dado con guida / <i>Wheel nut</i>	7/8"-14 UNF H tot. 50		-
10	729806	Dado con guida / <i>Wheel nut</i>	7/8"-14 UNF H tot. 56		-
11	729807	Dado con guida / <i>Wheel nut</i>	7/8"-14 UNF H tot. 78		-
12	732741	Coperchio per dado colonna / <i>Nut cover</i> Adattabile su tutti i dadi Ch. 32 mm. / <i>Suitable to all 32 mm. key nuts</i>	Ch / Key 32		3943983 1609675
13	729775	Ghiera fissaggio mozzo / <i>Axle nut</i>	.	F10 - F12 - F16 - FL7 - FL10 - FL12 FM7 - FM9 - FM10 - FM12 - FH12 - FH16	1522384
14	729773	Ghiera fissaggio mozzo / <i>Axle locking nut</i>	M86x2	FL6 - FL7 - FL12 - FM7 - FM9 FM10 - FM12 - FH12 - FH16	1076335
15	726374	Rondella di bloccaggio dado assale / <i>Lock washer</i>		FL6 - FL7 - FL12 - FM7 - FM9 M10 - FM12 - FH12 - FH16	8157714
16	713917	Mozzo ruota nudo / <i>Wheel hub, bare</i>		FM - FH	20535263
17	713776	Mozzo ruota completo / <i>Wheel hub assembly</i>		FH - FM	85107753 20535263
18	713919	Mozzo ruota completo di cuscinetto FAG <i>Wheel hub assembly (complete with FAG bearing)</i>		FH - FM	85107753 20535263
19	713777	Mozzo ruota completo / <i>Wheel hub assembly</i>		FM9 - FM12 - FH12 - FH16	85105696
20	713778	Mozzo ruota completo / <i>Wheel hub assembly</i>		FM9 - FM12 - FH12 - FH16	20517952
21	728706	Kit cuscinetto completo / <i>Bearing assembly</i>	ø 94x148x135	FH - FM - FM9 - FM12 - FH12 FH16	20967828 1075408 20518661 20792439 20792440 21036050
22	730760	Paraolio mozzo posteriore / <i>Oil seal</i>	ø 168x192,5x32	F7 - F10 - F12 - F16 FL7 - FL10 - FL12 FH12 - FH16	944666 1591903 1610765

**PONTE POST.
REAR AXLE**

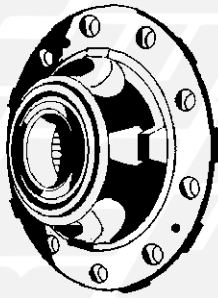

1 - 713901 Nudo / Bare
2 - 713902 Completo / Assembly

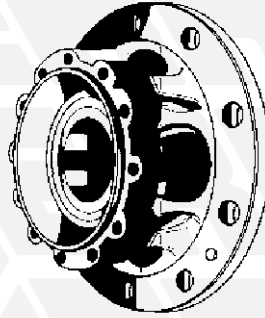

713799
3

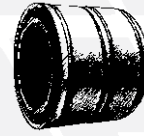

728706
4



730760
5

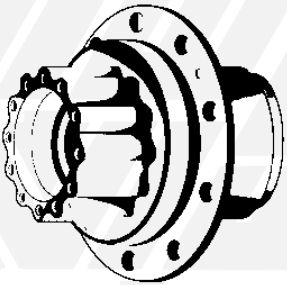

713900
6



7 - 728718 Int. / Inner
8 - 728719 Est. / Outer



730760
5

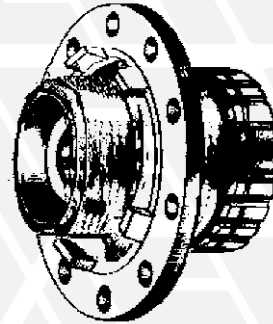

713944
9

NEW

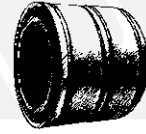

728706
4



727290
10



728711
11



728737
12

NEW



13 - 728733
14 - 728729
15 - 728723
16 - 728722
17 - 728731



730793
18

NEW



730791
19

NEW



730792
20

NEW

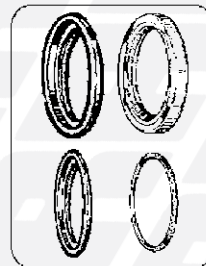

730779
21

FIG. ITEM	RIF. ERREVI ERREVI REF.	DESCRIZIONE PARTICOLARI DESCRIPTION		TIPO VEHICLE MODEL	RIF. ORIG. ORIG. REF.
1	713901	Mozzo ruota nudo / <i>Wheel hub, bare</i>		FH - FM - FH12 - FH16	20819804 20535207 20820402 21328181 21328177
2	713902	Mozzo ruota completo / <i>Wheel hub assembly</i>		FH - FM - FH12 - FH16	20819804S 20535207S 20820402S 21328181S 21328177S
3	713799	Mozzo ruota completo / <i>Wheel hub assembly</i>		Veicoli 6x4 da cantiere	20820420
4	728706	Kit cuscinetto completo / <i>Bearing assembly</i>	ø 94x148x135	FH - FM - FM9 - FM12 - FH12 - FH16	20967828 1075408 20518661 20792439 20792440 21036050
5	730760	Paraolio mozzo posteriore / <i>Oil seal</i>	ø 168x192,5x32	F7 - F10 - F12 - F16 FL7 - FL10 - FL12 FH12 - FH16	944666 1591903 1610765
6	713900	Mozzo ruota nudo / <i>Wheel hub, bare</i>		F10 - F12 - F16 - FL6 - FL10 - FL7 - FL12 NL10 - NL12 - NH12 - FH12 - FH16	1626992
7	728718	Cuscinetto interno mozzo / <i>Inner bearing</i>	ø 96x160x43	F10 - F12 - F16 - FL6 - FL10 - FL7 - FL12 NL10 - NL12 - NH12 - FH12 - FH16	184795 181278 181279
8	728719	Cuscinetto esterno mozzo / <i>Outer bearing</i>	ø 82,5x145x43	F10 - F12 - F16 - FL6 - FL10 - FL7 - FL12 NL10 - NL12 - NH12 - FH12 - FH16	184794 181280 181281
9	713944	Mozzo ruota completo / <i>Wheel hub assembly</i>		FM9 - FM12 FH12 - FH16 - FH	85109244 85107752 20819826
10	727290	Ruota fonica / <i>Impulse wheel</i>	ø 140x164x7 100 denti / <i>teeth</i>	FH12 - FH16 - FL6 FM9 - FM10 - FM12	20424109
11	728711	Kit cuscinetto completo / <i>Bearing assembly</i>	ø 78x130x90		85103257
12	728737	Kit cuscinetto completo (805011C) / <i>Bearing assembly</i>	ø 82x140x110	FL6	85103258
13	728733	Cuscinetto interno mozzo / <i>Hub bearing, inner</i>	ø 90x160x42,5		19468 32218A VKHB2030
14	728729	Cuscinetto esterno mozzo / <i>Hub bearing, outer</i>	ø 75x125x37	FL6	184678 33115 VKHB2222
15	728723	Cuscinetto interno mozzo / <i>Hub bearing, inner</i>	ø 95x145x32	FL	20593429 32019XA VKHB2161
16	728722	Cuscinetto esterno mozzo / <i>Hub bearing, outer</i>	ø 90x140x32	FL6	1699173 32018XA VKHB2170
17	728731	Cuscinetto interno mozzo / <i>Hub bearing, inner</i>	ø 100x157x42	F10 - F12 - N10 - N12 - FM7 - FM9 FM10 - FM12 - NL12 - FH12 FH16 FH - FM	183326 KHM220149,220,110 VKHB2032
18	730793	Paraolio interno differenziale / <i>Oil seal, inner</i>	ø 76x131,5x20	F10 - F12 - FH12 - FH16 - FL6 FM7 - FM9 - FM10 - FM12 - NH12 B7 - B10	1522895 943141
19	730791	Paraolio interno differenziale / <i>Oil seal, inner</i>	ø 76x150x20	F7 - F10 - F12 FL7 - FL10 N10	1522894 15228943 946257
20	730792	Paraolio interno mozzo / <i>Oil seal, inner</i>	ø 136x164,5x22	F10 - F12 - F16 - FH12 - FH16 - FH FL10 - FL12 - FL7 FM7 - FM9 - FM10 - FM12 - FM B10 - N10	1673683 3094807 1672249 1522372
21	730779	Kit paraolio per mozzo / <i>Oil seal kit</i>		FL6 - FL7 - FL10 - FL12 - FM7 FM10 - FM12 - FH12 - FH16	3095043 3095042 8159000

