

SOSPENSIONE / SUSPENSION

RICAMBI PER / SPARE PARTS FOR

ASTRA	pag.	328 - 335
DAF	pag.	336 - 343
FIAT-IVECO	pag.	344 - 345
IVECO	pag.	344 - 419
IVECO AUTOBUS	pag.	420 - 421
MAN	pag.	422 - 429
MERCEDES	pag.	430 - 435
NISSAN	pag.	434 - 435
RENAULT	pag.	436 - 439
SCANIA	pag.	440 - 445
VOLVO	pag.	446 - 457

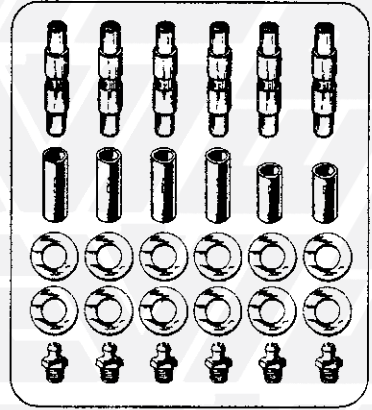
1 SOSPENSIONE ANTERIORE / FRONT SUSPENSION



725558 - 725559
2 3



4 - 721286 ϕ 14x170 T./Head 30 H. 16



711715
1



720224
5



726633 - 726634
6 7



722222 ϕ 22x92x225
8

2 SOSPENSIONE POSTERIORE / REAR SUSPENSION



9 - 721252 ϕ 16x265 T./Head 30 H. 15
10 - 721253 ϕ 16x305 T./Head 30 H. 15
11 - 721256 ϕ 16x240 T./Head 30 H. 15
12 - 721257 ϕ 16x285 T./Head 30 H. 15



ϕ 50

730314
16



729318
14



727026
15



13 - 721288 ϕ 16x290 T./Head 24 H. 16



19 - 722184 ϕ 24x100x445
20 - 722179 ϕ 24x100x485



17 - 723530 ϕ 24x100x420
18 - 723532 ϕ 24x100x460



713200
21

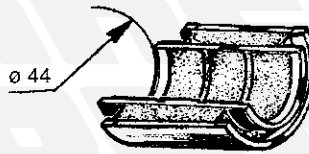
FIG. ITEM	RIF. ERREVI ERREVI REF.	DESCRIZIONE PARTICOLARI DESCRIPTION	TIPO VEHICLE MODEL	RIF. ORIG. ORIG. REF.
<h1>ASTRA</h1> <p>BM304F - BM305F - BM64.26 - BM64.30 - BM64.36 HD7 (64.34 - 64.38 - 64.42 - 64.45 - 64.52)</p>				
<h2>1 SOSPENSIONE ANTERIORE / FRONT SUSPENSION</h2>				
1	711715	Completivo revisione balestra / <i>Spring repair kit</i>	BM64.26 - 64.30 - 64.36 HD7 (64.34-64.38-64.42-64.45-64.52)	-
2	725558	Boccola occhio balestra / <i>Spring eye bush</i>	∅ 38x50x90	115318 42543 115330
3	725559	Boccola biscottino / <i>Shackle bush</i>	∅ 38x50x87	55097
4	721286	Bullone centrale c/dado Prol. / <i>Centre bolt c/w nut</i>	∅ 14x170 T./Head 30 H.16	HD7 (64.34-64.38-64.42-64.45-64.52) -
5	720224	Perno balestra e biscottino / <i>Spring and shackle pin</i>	∅ 30/38x154	BM64.26 - 64.30 - 64.36 HD7 (64.34-64.38-64.42-64.45-64.52) 150072
6	726633	Rondella rasamento occhio balestra / <i>Spring eye washer</i>	∅ 38,5x68x1,5	BM304F -BM305F 55099
7	726634	Rondella rasamento occhio balestra / <i>Spring eye washer</i>	∅ 30,5x68x1,5	BM64.26 - 64.30 - 64.36 HD7 (64.34-64.38-64.42-64.45-64.52) 150084
8	722222	Staffa QUADRA PIATTA c/dadi / <i>U bolt c/w nuts</i>	∅ 22x92x225	HD7 (64.34-64.38-64.42-64.45-64.52) 151138
<h2>2 SOSPENSIONE POSTERIORE / REAR SUSPENSION</h2>				
9	721252	Bullone centrale c/dado / <i>Centre bolt c/w nut</i>	∅ 16x265 T./Head 30 H.15	BM304F -BM305F 103552
10	721253	Bullone centrale c/dado / <i>Centre bolt c/w nut</i>	∅ 16x305 T./Head 30 H.15	BM304F -BM305F 102449
11	721256	Bullone centrale c/dado / <i>Centre bolt c/w nut</i>	∅ 16x240 T./Head 30 H.15	BM64.26 - 64.30 - 64.36 111354
12	721257	Bullone centrale c/dado / <i>Centre bolt c/w nut</i>	∅ 16x285 T./Head 30 H.15	BM64.26 - 64.30 - 64.36 111356
13	721288	Bullone centrale c/dado PROL. / <i>Centre bolt c/w nut</i>	∅ 16x290 T./Head 24 H.16	HD7 (64.34-64.38-64.42-64.45-64.52) -
14	729318	Dado bombato per staffa bal. / <i>U bolt nut</i>		HD7 (64.34-64.38-64.42-64.45-64.52) 170751
15	727026	Distanziale bombato per dado staffa / <i>Spacer</i>		HD7 (64.34-64.38-64.42-64.45-64.52) 170750
16	730314	Semiboccola barra stabilizzatrice / <i>Stabilizer bar half-bushing</i>	∅ int. 50	HD7 (64.34-64.38-64.42-64.45-64.52) 110378
17	723530	Staffa Semitonda c/dadi e controdadi / <i>U bolt c/w nuts</i>	∅ 24x100x420	BM304F -BM305F 100851
18	723532	Staffa Semitonda c/dadi e controdadi / <i>U bolt c/w nuts</i>	∅ 24x100x460	BM304F -BM305F 100850
19	722184	Staffa Semitonda PIATTA c/dadi / <i>U bolt c/w nuts</i>	∅ 24x100x445	HD7 (64.34-64.38-64.42-64.45-64.52) 115049
20	722179	Staffa Semitonda PIATTA c/dadi / <i>U bolt c/w nuts</i>	∅ 24x100x485	HD7 (64.34-64.38-64.42-64.45-64.52) 116028
21	713200	Testa a snodo fiss. barra stabilizzatrice / <i>Stabilizer bar ball joint</i>		HD7 (64.34-64.38-64.42-64.45-64.52) 110382

SOSPENSIONE SUSPENSION

SOSPENSIONE ANTERIORE / FRONT SUSPENSION



1 - 725529
2 - 725528



730281
14



730250
3



720230
7



730370
4



720231
8



729649
10



730371
5



720232
9



721084
11



15 - 722747
16 - 722748
17 - 722750



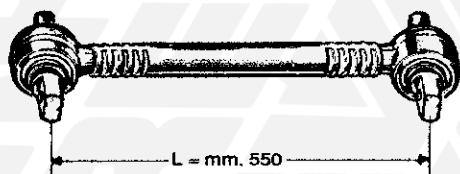
730353
6



12 - 726372
13 - 726357

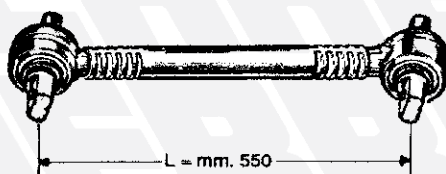
FIG. ITEM	RIF. ERREVI ERREVI REF.	DESCRIZIONE PARTICOLARI DESCRIPTION		TIPO VEHICLE MODEL	RIF. ORIG. ORIG. REF.
HD8 (4x2 - 4x4 - 6x4 - 6x6 - 8x4) HD9 (4x2 - 4x4 - 6x4 - 6x6 - 8x4 - 8x6 - 8x8) SOSPENSIONE ANTERIORE / FRONT SUSPENSION					
1	725529	Boccola balestra - LATO ANTERIORE <i>Spring eye bush (rear end)</i>	∅ 37x60x87	HD8 (4x2-4x4-6x4-6x6-8x4) HD9 48.48 - HD9 (8x8)	131365 98343246
2	725528	Boccola balestra c/ragnatura - LATO POSTERIORE <i>Spring eye bush (rear end)</i>	∅ 37x60x87	HD8 (4x2-4x4-6x4-6x6-8x4) HD9 (4x2-4x4-6x4-6x6-8x4-8x6-8x8)	184414 500437318
3	730250	Boccola elastica per tirante barra stabilizzatrice / <i>Rubber bush</i>	∅ 28x50x62,2	HD8 (4x2-4x4-6x4-6x6-8x4) HD9 (6x6-8x4-8x6-8x8)	8162306
4	730370	Boccola elastica completa di perno - LATO ANTERIORE <i>Spring pin bush (front end)</i>	∅ est. 62,5	HD8 (8x4)	131539
5	730371	Boccola elastica - LATO POSTERIORE / <i>Spring bush (rear end)</i>	∅ 20,5x62,8x109	HD8 (8x4)	131539
6	730353	Boccola elastica - LATO POSTERIORE <i>Spring bush (rear end)</i>	∅ 36x61,2x90	HD8 (8x4) 2° asse	124571 2997221
7	720230	Perno balestra - LATO ANTERIORE / <i>Spring pin, front end</i>	∅ 30x37x154	HD8 (4x2-4x4-6x4-6x6-8x4) HD9 (4x2-4x4-6x4-6x6-8x4-8x6-8x8)	184511 98184511
8	720231	Perno balestra - LATO POSTERIORE / <i>Spring pin (rear end)</i>	∅ 23x37x109	HD8 (4x2-4x4-6x4-6x6-8x4) HD9 (4x2-4x4-6x4-6x6-8x4-8x6-8x8)	183573 98183573
9	720232	Perno fissaggio balestra / <i>Spring pin</i>	∅ 20x165	HD8 (4x2-4x4-6x4-6x6-8x4) HD9 (4x2-4x4-6x4-6x6-8x4-8x6-8x8)	184421 98184421
10	729649	Dado aut. per perno / <i>Nut</i>	M20x2,5	HD8 (4x2-4x4-6x4-6x6-8x4) HD9 (4x2-4x4-6x4-6x6-8x4-8x6-8x8)	124569 16750721
11	721084	Perno ancoraggio barra stabilizzatrice / <i>Stabilizer bar pin</i>	∅ 28x62	HD8 (4x4-6x6) HD9 (4x2-4x4-6x4-6x6-8x4-8x6-8x8)	124599 42120135
12	726372	Rondella rasamento occhio balestra <i>Spring washer</i>	∅ 37x68x4,5	HD8 (4x2-4x4-6x4-6x6-8x4) HD9 (4x2-4x4-6x4-6x6-8x4-8x6-8x8)	500434945 184513
13	726357	Rondella rasamento occhio balestra / <i>Spring washer</i>	∅ 37x88x3,5	HD8 (8x4) 2° asse	124570
14	730281	Semiboccola barra stabilizzatrice / <i>Stabilizer bar half-bushing</i>	∅ int. 44	HD8 (4x2-4x4-6x4-6x6-8x4) HD9 (4x2-4x4-6x4-6x6-8x4-8x6-8x8)	124563 5949782585
15	722747	Staffa balestra QUADRA PIATTA c/dadi - LATO ANTERIORE <i>U Bolt c/w nuts (front end)</i>	∅ 20x90x270	HD8 (4x2-6x4-8x4) HD9 (4x2-6x4-8x4)	184420 98184420
16	722748	Staffa balestra QUADRA PIATTA c/dadi - LATO POSTERIORE <i>U Bolt c/w nuts (rear end)</i>	∅ 20x90x220	HD8 (4x2-6x4-8x4) HD9 (4x2-6x4-8x4)	184418 98184418
17	722750	Staffa balestra QUADRA PIATTA c/dadi / <i>U Bolt c/nuts</i>	∅ 20x90x390	HD8 (4x4-6x6) HD9 (4x4-4x6-8x6-8x8)	500402647

SOSPENSIONE POSTERIORE / REAR SUSPENSION



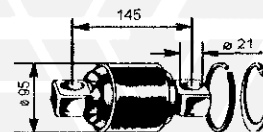
712997

1



712998

2



730237

3



4 - 725529

5 - 725528



8 - 721291

9 - 721290



720230

12



730383

6



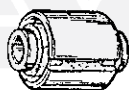
10 - 729462

11 - 729463



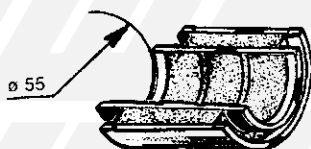
720231

13



730250

7



730280

19



20 - 722184

21 - 722179

22 - 722197



720232

14



729649

15



726372

18



729649

17

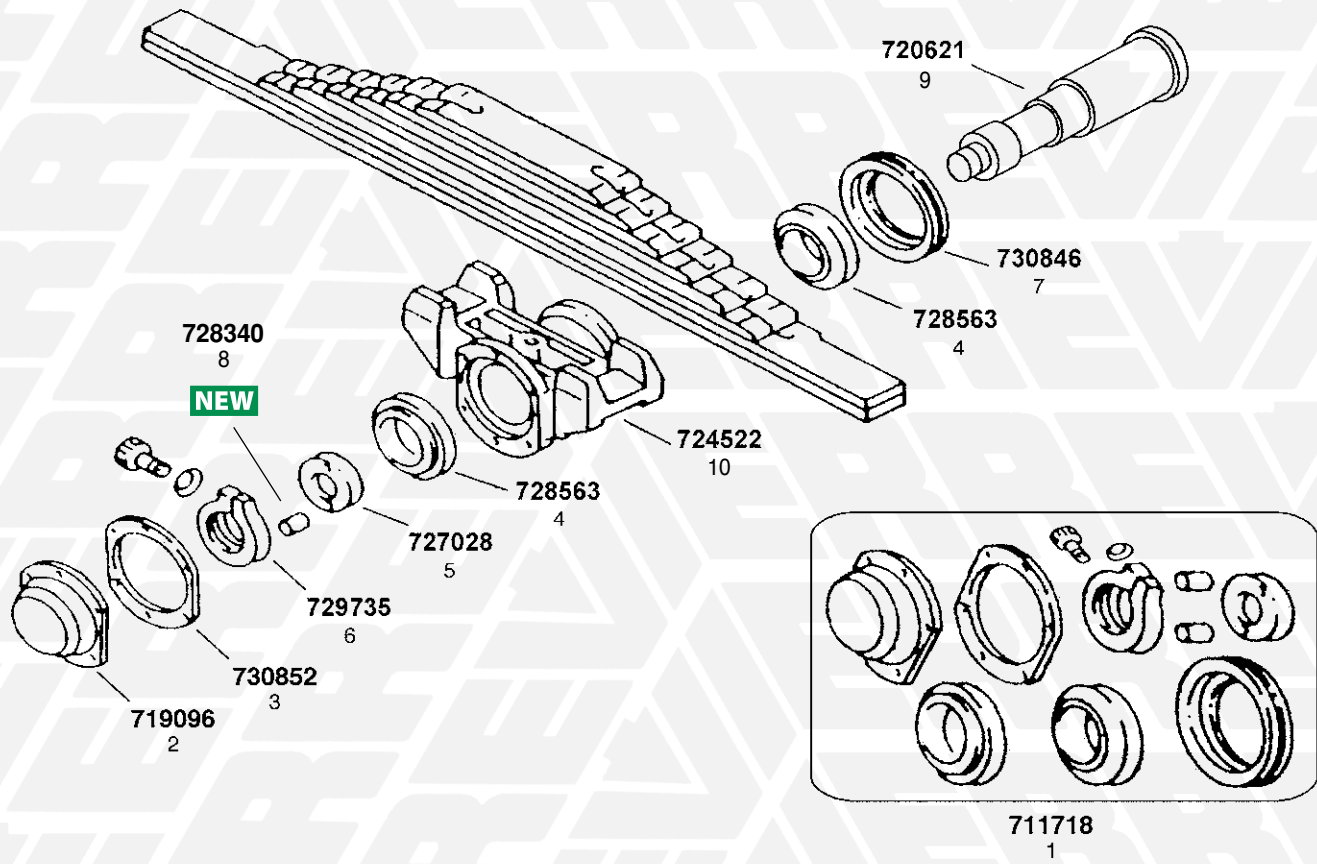


721084

16

FIG. ITEM	RIF. ERREVI ERREVI REF.	DESCRIZIONE PARTICOLARI DESCRIPTION		TIPO VEHICLE MODEL	RIF. ORIG. ORIG. REF.
HD8 (4x2 - 4x4 - 6x4 - 6x6 - 8x4) HD9 (4x2 - 4x4 - 6x4 - 6x6 - 8x4 - 8x6 - 8x8) SOSPENSIONE POSTERIORE / REAR SUSPENSION					
1	712997	Barra di reazione / <i>Torque arm</i>	L= 550	HD8 (6x4-8x4)	175809
2	712998	Barra di reazione con perni inclinati / <i>Torque arm</i>	L= 550	HD8 (6x6)	175810
3	730237	Kit revisione barra di reazione / <i>Torque arm repair kit</i>		HD8 (6x4-8x4-6x6)	-
4	725529	Boccola balestra - LATO ANTERIORE <i>Spring eye bush (rear end)</i>	ø 37x60x87	HD8 (4x2-4x4) HD9 (8x8)	131365 98343246
5	725528	Boccola balestra c/ragnatura - LATO POSTERIORE <i>Spring eye bush (rear end)</i>	ø 37x60x87	HD8 (4x2-4x4) HD9 (4x2-4x4)	184414 500437318
6	730383	Boccola elastica barra stabilizzatrice <i>Silentblock, stabilizer bar</i>	ø 28x60x44/50	HD8 (4x2-4x4) HD9 (4x2-4x4)	41218902 500336108
7	730250	Boccola elastica per tirante barra stabilizzatrice / <i>Rubber bush</i>	ø 28x50x62,2	HD8	8162306
8	721291	Bullone centrale c/dado / <i>Centre bolt c/w nut</i>	ø 16x280 T24 H16	HD8 (6x4-8x4) - HD9 (6x4-8x4)	133134
9	721290	Bullone centrale c/dado / <i>Centre bolt c/w nut</i>	ø 16x220 T30 H12	HD8 (6x4-8x4) - HD9 (6x4-8x4)	118417
10	729462	Bullone fissaggio supporto barra / <i>Bolt</i>	ø 20x235	HD8 (6x4-8x4) - HD9 (6x4-8x4)	185429 98185429
11	729463	Bullone fissaggio supporto barra / <i>Bolt</i>	ø 20x295	HD8 (6x6) - HD9 (6x6-8x6-8x8)	185430 98185430
12	720230	Perno balestra - LATO ANTERIORE / <i>Spring pin, front end</i>	ø 30x37x154	HD8 (4x2-4x4) HD9 (4x2-4x4-6x4-6x6-8x4-8x6-8x8)	184511 98184511
13	720231	Perno balestra - LATO POSTERIORE / <i>Spring pin (rear end)</i>	ø 23x37x109	HD8 (4x2-4x4) HD9 (4x2-4x4-6x4-6x6-8x4-8x6-8x8)	183573 98183573
14	720232	Perno fissaggio balestra / <i>Spring pin</i>	ø 20x165	HD8 (4x2-4x4) HD9 (4x2-4x4-6x4-6x6-8x4-8x6-8x8)	184421 98184421
15	729649	Dado aut. per perno	M20x2,5	HD8 (4x2-4x4) HD9 (4x2-4x4-6x4-6x6-8x4-8x6-8x8)	124569 16750721
16	721084	Perno ancoraggio barra stabilizzatrice / <i>Stabilizer bar pin</i>	ø 28x62	HD8 (4x2-4x4) - HD9 (4x2-4x4)	124599 42120135
17	729649	Dado aut. per perno	M20x2,5	HD8 (4x2-4x4) - HD9 (4x2-4x4)	124569 16750721
18	726372	Rondella rasamento occhio balestra <i>Spring washer</i>	ø 37x68x4,5	HD8 (4x2-4x4) HD9 (4x2-4x4-6x4-6x6-8x4-8x6-8x8)	500434945 184513
19	730280	Semiboccola barra stabilizzatrice / <i>Stabilizer bar half-bushing</i>	ø int. 55	HD8 (4x2-4x4-6x4-6x6-8x4) HD9 (4x2-4x4-6x4-6x6-8x4-8x6-8x8)	124602 5949782586
20	722184	Staffa balestra SEMITONDA PIATTA c/dadi / <i>U bolt c/w nuts</i>	ø 24x100x445	HD8 (6x4-8x4) - HD9 (6x4-8x4)	115049
21	722179	Staffa balestra SEMITONDA PIATTA c/dadi / <i>U bolt c/w nuts</i>	ø 24x100x485	HD8 (6x4-8x4) - HD9 (6x4-8x4)	116028
22	722197	Staffa balestra SEMITONDA PIATTA c/dadi / <i>U Bolt c/w nuts</i>	ø 24x100x520	HD8 (6x4-6x6-8x4) HD9 (6x4-6x6-8x4-8x6-8x8)	118499 42052372

1 **BILANCIERE / EQUALIZER ASSY**
HD7



2 **BILANCIERE / EQUALIZER ASSY**
HD8 - HD9

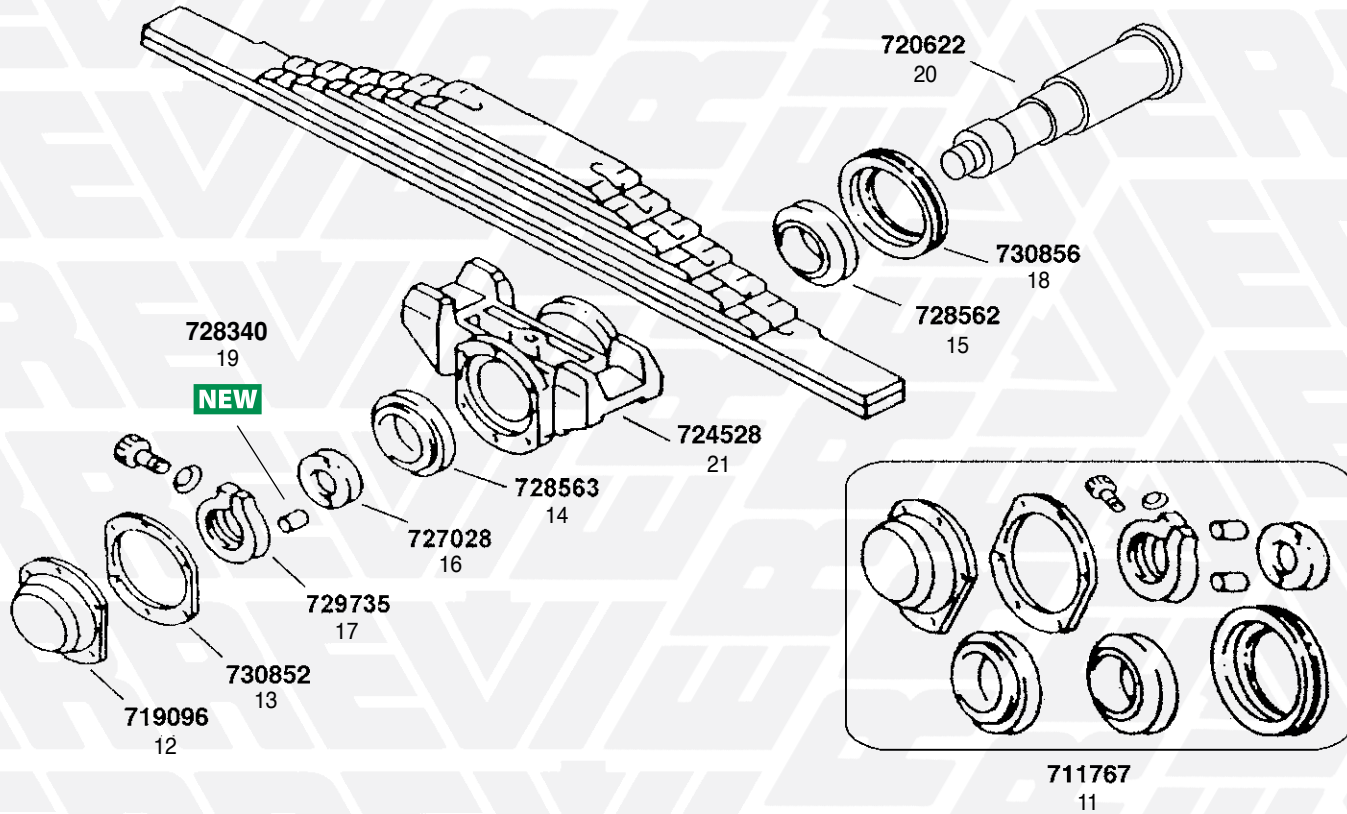
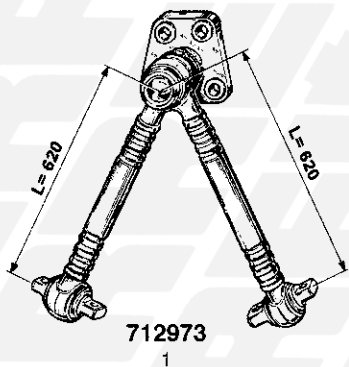
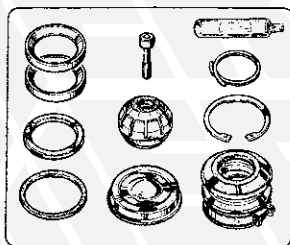


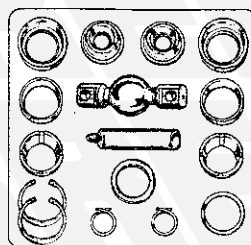
FIG. ITEM	RIF. ERREVI ERREVI REF.	DESCRIZIONE PARTICOLARI DESCRIPTION	TIPO VEHICLE MODEL	RIF. ORIG. ORIG. REF.
1 HD7 (64.34 - 64.38 - 64.42 - 64.45 - 64.52) BILANCIERE / EQUALIZER ASSY				
1	711718	Serie completa revisione bilanciere composta da: Rocker beam repair kit, inclusive of:		-
2	719096	(1) Calotta / Cup		185181
3	730852	(1) Guarnizione calotta / Gasket	ø 170x210x2	185564
4	728563	(2) Cuscinetto esterno / Outer bearing	ø 110x160x37	180527
5	727028	(1) Distanziale / Spacer	ø 61x124x10	180513
6	729735	(1) Ghiera perno centrale / Locknut	M60x2 H=27	178479
7	730846	(1) Guarnizione adiprene / Gasket	ø 181x197x14	35099
8	728340	(2) Spina di fissaggio / Dowel	ø 10x18	178501 98178501
		(1) Vite per ghiera / Locknut screw	M12x45	7285
		(1) Rondella zigrinata / Spring eye washer	ø 13x17,6x1	-
9	720621	Perno centrale bilanciere Rocker-beam pin	ø 110x360	180510
10	724522	Supporto centrale bilanciere / Trunnion		182738
2 HD8 (6x4 - 6x6 - 8x4) HD9 (6x4 - 6x6 - 8x4) BILANCIERE / EQUALIZER ASSY				
11	711767	Serie completa revisione bilanciere composta da: Rocker beam repair kit, inclusive of:		-
12	719096	(1) Calotta / Cup		185181 98185181
13	730852	(1) Guarnizione calotta / Gasket	ø 170x210x2	185564 98185564
14	728563	(1) Cuscinetto esterno / Outer bearing	ø 110x160x37	180527 98180527
15	728562	(1) Cuscinetto interno / Inner bearing	ø 120x180x38	124612 8138308
16	727028	(1) Distanziale / Spacer	ø 61x124x10	180513 98180513
17	729735	(1) Ghiera perno centrale / Locknut	M60x2 H=27	178479 500421623
18	730856	(1) Guarnizione adiprene / Gasket	ø 181x197x14	185196 98165196 98185196
19	728340	(2) Spina di fissaggio / Dowel	ø 10x18	178501 98178501
		(1) Vite per ghiera / Locknut screw	M12x45	7285
		(1) Rondella zigrinata / Spring eye washer	ø 13x17,6x1	-
20	720622	Perno centrale bilanciere Rocker-beam pin	ø110,2x120x361,5	184614 98184614
21	724528	Supporto centrale bilanciere Trunnion		184858 98184858



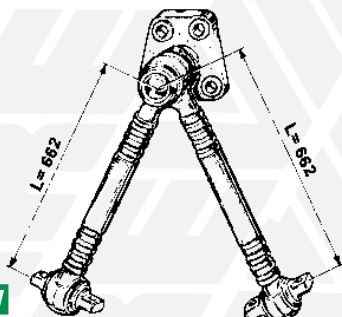
712973
1



730206
2

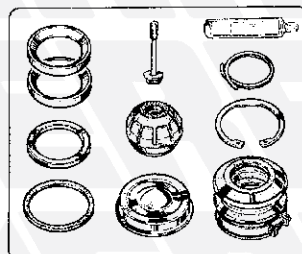


730200
3

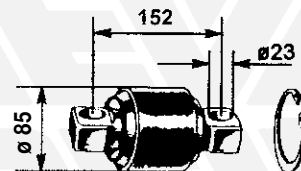


NEW

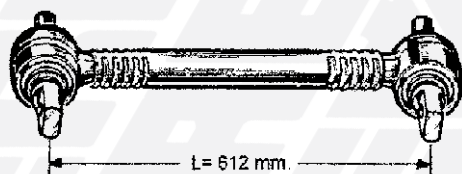
712872
4



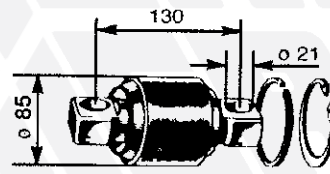
730240
5



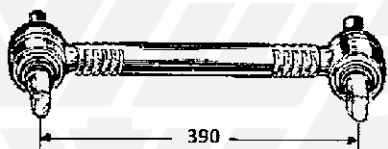
730451
6



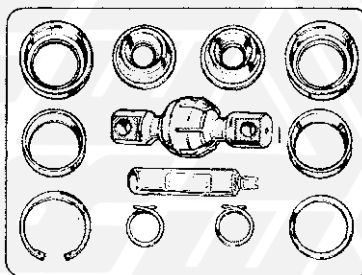
712989
7



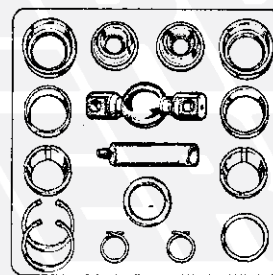
730442
8



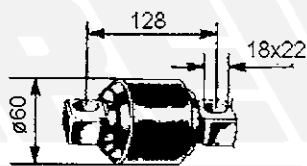
712868
9



730191
10

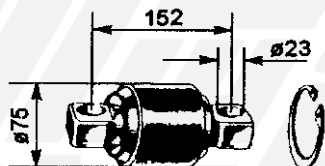


730200
11

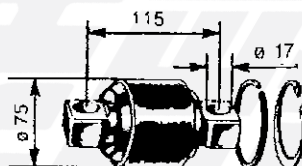


730881
13

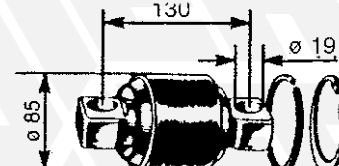
NEW



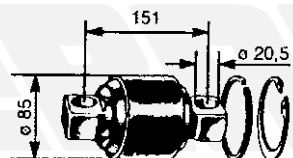
730450
14



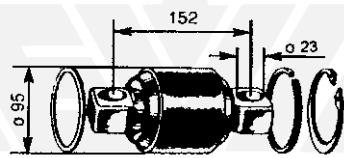
730916
15



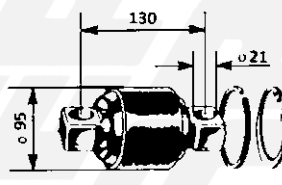
730186
16



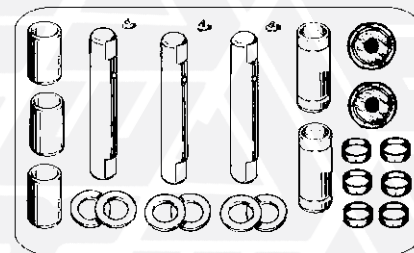
730201
17



730443
18



730972
19

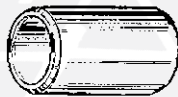


711055
12

FIG. ITEM	RIF. ERREVI ERREVI REF.	DESCRIZIONE PARTICOLARI DESCRIPTION	TIPO VEHICLE MODEL	RIF. ORIG. ORIG. REF.
<h1>DAF</h1> <h2>SOSPENSIONI / SUSPENSIONS</h2>				
1	712973	Barra di reazione angolare <i>Angle torque arm</i>	65CF - 75CF - 85CF 95XF - XF95	80521 1361651 1368270 1390932 1617096 276875
2	730206	Kit revisione barra angolare - PARTE CENTRALE <i>Angle torque arm repair kit</i>	65CF - 75CF - 85CF - 95XF - XF95	691704
3	730200	Kit revisione barra angolare - PARTE LATERALE <i>Angle torque arm repair kit</i>	65CF - 75CF - 85CF - 95XF - XF95	693778
4	712872	Barra di reazione angolare / <i>Angle torque arm</i>	75CF - 85CF - 95XF CF75 - CF85	1620436 1361652 1793876
5	730240	Kit revisione barra angolare (649819-658102) - PARTE CENTRALE <i>Angle torque arm repair kit</i>	75CF - 85CF - 95XF CF75 - CF85	696320
6	730451	Kit revisione barra di reazione <i>Torque arm repair kit</i>	65CF - 75CF - 85CF CF65 - CF75 - CF85 - 95XF	698724
7	712989	Barra di reazione / <i>Torque arm</i>	L = 612 mm 65CF - 75CF - 85CF - 95XF CF65 - CF75 - CF85 LF55 - XF95 - XF105	0267743 1361649 1361650 1656428
8	730442	Kit revisione barra di reazione <i>Torque arm repair kit</i>	65CF - 75CF - 85CF 95XF	513757 691709
9	712868	Barra di reazione / <i>Torque arm</i>	L = 390 mm 75CF - 95XF CF75 - CF85 - XF95 - XF105	1261101
10	730191	Kit revisione barra con perno / <i>Torque arm repair kit c/w pin</i>		1271124
11	730200	Kit revisione barra angolare - PARTE LATERALE <i>Angle torque arm repair kit</i>	65CF - 75CF - 85CF - 95XF - XF95	693778
12	711055	Compressivo revisione balestra anteriore / <i>Spring repair kit, front</i>	CF65 - CF75 - CF85 - LF55 XF95 - XF105	038907151
13	730881	Perno gommato balestra / <i>Spring pin</i>	ø 60 CF85 - XF95 - XF105	1681114
14	730450	Kit revisione barra di reazione <i>Torque arm repair kit</i>	LF55 - CF65 - CF75 - CF85 95XF - XF95 - XF105	1376729
15	730916	Kit revisione barra di reazione / <i>Torque arm repair kit</i>	75CF - 85CF - CF75/85 - XF95/105	689748
16	730186	Kit revisione barra angolare (658102) e barra di reazione (658104) <i>Angle torque arm repair kit</i>		689749
17	730201	Kit revisione barra / <i>Torque arm repair kit</i>	F2100-2300-2500-2700-3200-3300	691703
18	730443	Kit revisione barra di reazione / <i>Torque arm repair kit</i>	65CF-75CF-85CF-95XF	696321
19	730972	Kit revisione barra di reazione / <i>Torque arm repair kit</i>	75CF - 95XF - CF75 - CF85 - XF95 XF105	689761



1 - 730906



2 - 726095



4 - 730937



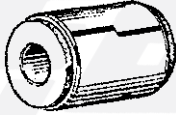
3 - 730938



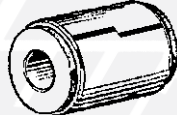
5 - 730960



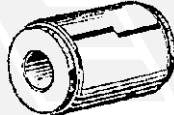
6 - 730961



730350
7

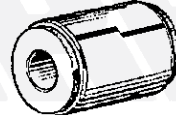


730351
8



730877
9

NEW



730354
10



726141
11



726142
12



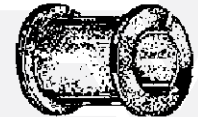
730904
13



730903
14



730372
15



730106
16

NEW



17 - 722079 \varnothing 16x80x165
18 - 722080 \varnothing 16x80x180



19 - 722081 \varnothing 20x77x350
20 - 722082 \varnothing 20x77x370
21 - 722083 \varnothing 20x77x445
22 - 722089 \varnothing 20x92x160
23 - 722084 \varnothing 22x92x440
24 - 722085 \varnothing 24x146x265
25 - 722086 \varnothing 24x156x290



26 - 722087 \varnothing 22x92x210



27 - 722088 \varnothing 22x100x220



729629
29



727400
28

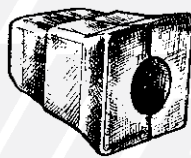


729629
29



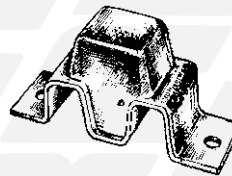
730873
30

NEW



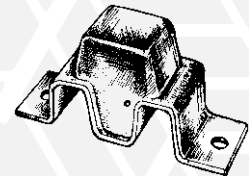
730874
31

NEW



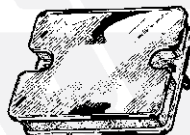
730875
32

NEW

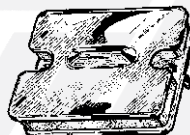


730876
33

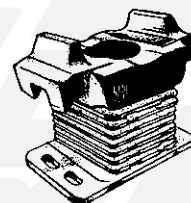
NEW



730962
34

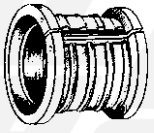


730963
35



730093
36

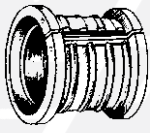
FIG. ITEM	RIF. ERREVI ERREVI REF.	DESCRIZIONE PARTICOLARI DESCRIPTION		TIPO VEHICLE MODEL	RIF. ORIG. ORIG. REF.
SOSPENSIONI / SUSPENSIONS					
1	730906	Boccola in gomma ammortizzatore / <i>Shockabsorber rubber bush</i>	ø 20x50x21	LF45 - LF55	1620344
2	726095	Boccola ammortizzatore anteriore / <i>Shockabsorber bush, front</i>	ø 26x31x52,5	CF65 - CF75 - CF85 - LF55 - XF95 XF105	0679253
3	730938	Boccola elastica occhio balestra / <i>Silentblock</i>	ø est. / out. 45	LF45	1401681
4	730937	Boccola elastica balestra anteriore / <i>Silentblock</i>	ø 16,5x45x82	LF45 - LF55	1401539
5	730960	Boccola elastica balestra / <i>Silentblock</i>	ø 18,75x52x97	LF55 - CF65	1401489
6	730961	Boccola elastica balestra / <i>Silentblock</i>	ø est 52 L= 157,5	LF55 - CF65	1401487
7	730350	Boccola elastica occhio balestra anteriore / <i>Silentblock</i>	ø 24,2x63x86	65CF - 75CF - 85CF LF55 - CF75 - CF85	1357764
8	730351	Boccola elastica occhio balestra anteriore / <i>Silentblock</i>	ø 24,2x63x106	65CF - 75CF - 85CF CF65 - CF75 - CF85	1368283
9	730877	Boccola elastica occhio balestra / <i>Silentblock</i>	ø 25x60x96	Serie CF Series Motore Euro 6 Engine	1890049
10	730354	Boccola elastica occhio balestra / <i>Silentblock</i>	ø 20x60x60		1283618
11	726141	Boccola balestra anteriore / <i>Spring bush, front</i>	ø 37x48,5x75,5	75CF - 85CF - 95XF - CF75 - CF85 XF95 - XF105	0092960
12	726142	Boccola balestra / <i>Spring bush</i>	ø 32x37x53	CF75 - CF85 - XF95 - XF105	0092961
13	730904	Boccola balestra / <i>Spring eye bush</i>	ø 31x39x75	95FA - 95FAC - 95FAD 95FAT - 95XF	679254
14	730903	Boccola balestra / <i>Spring eye bush</i>	ø 37x49x95	95FA - 95FAC - 95FAD	266411
15	730372	Boccola elastica occhio balestra / <i>Silentblock</i>	ø 24x61,2x86	CF75 - CF85 - XF95 - XF105	1671219
16	730106	Boccola elastica barra stabilizzatrice posteriore <i>Stabilizer bar bush, rear</i>	ø 50x70x75	65CF - 75CF - 85CF - 95XF CF75 - CF85 - XF95 - XF105	0268045
17	722079	Staffa balestra TONDA c/dadi / <i>U-bolt c/w nuts</i>	ø 16x80x165	Serie LF / Series	1706302
18	722080	Staffa balestra TONDA c/dadi / <i>U-bolt c/w nuts</i>	ø 16x80x180	Serie LF / Series	1706303
19	722081	Staffa balestra SEMITONDA PIATTA c/dadi / <i>U-bolt c/w nuts</i>	ø 20x77x350	Serie LF / Series	1706309
20	722082	Staffa balestra SEMITONDA PIATTA c/dadi / <i>U-bolt c/w nuts</i>	ø 20x77x370	Serie LF / Series	1706308
21	722083	Staffa balestra SEMITONDA PIATTA c/dadi / <i>U-bolt c/w nuts</i>	ø 20x77x445	Serie LF / Series	1706311
22	722089	Staffa balestra SEMITONDA PIATTA c/dadi / <i>U-bolt c/w nuts</i>	ø 20x92x160	Serie XF / Series Serie CF / Series	1849356
23	722084	Staffa balestra SEMITONDA PIATTA c/dadi / <i>U-bolt c/w nuts</i>	ø 22x92x440	Serie LF / Series	1706313
24	722085	Staffa balestra SEMITONDA PIATTA c/dadi / <i>U-bolt c/w nuts</i>	ø 24x146x265	Serie XF / Series Serie CF / Series	0593707
25	722086	Staffa balestra SEMITONDA PIATTA c/dadi / <i>U-bolt c/w nuts</i>	ø 24x156x290	Serie XF / Series Serie CF / Series	0529939 1209785
26	722087	Staffa balestra SEMITONDA c/dadi / <i>U-bolt c/w nuts</i>	ø 22x92x210	Serie LF / Series	1706300
27	722088	Staffa balestra SEMITONDA c/dadi / <i>U-bolt c/w nuts</i>	ø 22x100x220	Serie XF / Series Serie CF / Series	0539023 0672340
28	727400	Tirante per balestra / <i>Control rod</i>	M22x1,5 L=395	75CF - 85CF - 95XF	1332634
29	729629	Dado per tirante / <i>Nut</i>	M22x1,5 H=31	75CF - 85CF - 95XF	652575
30	730873	Tampone paracolpo balestra anteriore / <i>Spring buffer, front</i>		65CF - 75CF - 85CF - 95XF LF45 - XF95	0266031
31	730874	Tampone paracolpo balestra anteriore / <i>Rubber buffer, front</i>		LF45	1401541
32	730875	Tampone paracolpo balestra posteriore / <i>Buffer, rear</i>		LF45 - LF55	1401576
33	730876	Tampone paracolpo balestra anteriore / <i>NBuffer, front</i>		LF45 - LF55	1401504
34	730962	Tassello distanziale per foglia balestra, anteriore <i>Spring buffer, front</i>		65CF - 75CF - 85CF CF65 - CF75 - CF85 - XF95 - XF105	1628826 1656439
35	730963	Tassello distanziale per foglia balestra, posteriore <i>Spring buffer, rear</i>		CF75 - CF85 - XF95 - XF105	1628828 1656440
36	730093	Tassello elastico per balestra / <i>Spring core</i>		F75 - F85 - F95 CF75 - CF85 - XF95 - XF105 75CF - 85CF - 95XF	1699564 1779767



730878

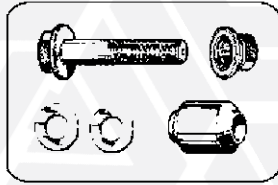
1

NEW

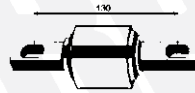


730905

2



3 - 711848



730933

5



730935

6



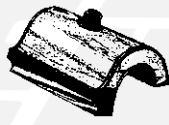
730941

7



730934

8



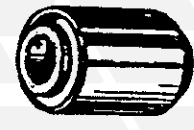
730940

9



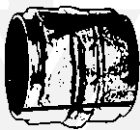
730448

10



730444

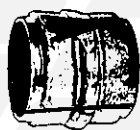
11



730879

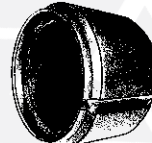
12

NEW



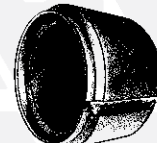
730445

13



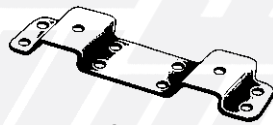
730447

14



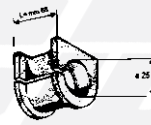
730446

15



727414

16



730943

17

FIG. ITEM	RIF. ERREVI ERREVI REF.	DESCRIZIONE PARTICOLARI DESCRIPTION	TIPO VEHICLE MODEL	RIF. ORIG. ORIG. REF.	
RICAMBI PER BARRA STABILIZZATRICE / STABILIZER BAR PARTS					
1	730878	Boccola elastica barra stabilizzatrice / <i>Stabilizer rubber bush</i>	ø 33,5x68x68,5	1890115	
2	730905	Boccola elastica per barra stabilizzatrice / <i>Stabilizer bar, bush</i>	ø 48x83/93x75	65CF - 75CF - 85CF - 95XF CF65 - CF75 - CF85	1323838
3	711848	Complessivo revisione barra stabilizzatrice ant. Stabilizer bar, repair kit Composto da / Complete with:		LF45 - LF55	14003965
		(1) Bullone / <i>Bolt</i>	M16x2	-	-
		(2) Rondella / <i>Washer</i>	ø 16,5x44x4	-	-
4	730939	(1) Boccola elastica barra stabilizz. ant. / <i>Bush</i>	ø 17x36,70x48		1400396
5	730933	Perno gommato barra stabilizzatrice ant. / <i>Stabilizer bar, pin</i>	ø 41,5 Int. / Cent. dist. 130	LF45	1402564
6	730935	Semiboccola barra stabilizzatrice ant. / <i>Stabilizer bar, half bushing</i>	ø int. / inn. 40	LF45	1402572 1402579
7	730941	Semiboccola barra stabilizzatrice ant. / <i>Stabilizer bar, half bushing</i>	ø int. / I.D. 33	LF45	1700604
8	730934	Semiboccola barra stabilizzatrice ant. / <i>Stabilizer bar, half bushing</i>	ø int. / I.D. 35	LF45	1402571 1405078
9	730940	Semiboccola barra stabilizzatrice / <i>Stabilizer bar, half bushing</i>	ø int. / I.D. 38	LF45	1700605
10	730448	Silentblock per braccio barra stabilizzatrice anteriore <i>Silentblock, front stabilizer bar</i>	ø 16x46,5x26/50	65CF - 75CF - 85CF CF65 - CF75 - CF85 - 95XF	1273279 1287999
11	730444	Silentblock per braccio barra stabilizzatrice posteriore <i>Silentblock, rear stabilizer bar</i>	ø 20x55x56	65CF - 75CF - 85CF 95XF	295726
12	730879	Boccola elastica barra stabilizzatrice <i>Stabilizer rubber bush</i>	ø 38x69,5x60,5	65CF - 75CF - 85CF - 95XF CF95 - CF75 - CF85 - XF95	1732886 1288000
13	730445	Silentblock barra stabilizzatrice anteriore <i>Silentblock, front stabilizer bar</i>	ø 43x61,5x60	75CF - 85CF CF75 - CF85 - 95XF - XF95	1732887 1291233
14	730447	Silentblock barra stabilizzatrice posteriore <i>Silentblock, rear stabilizer bar</i>	ø 57x85x60	65CF - 75CF - 85CF 95XF	558864
15	730446	Silentblock barra stabilizzatrice posteriore <i>Silentblock, rear stabilizer bar</i>	ø 65x84x60	95XF	366351
16	727414	Supporto per barra stabilizzatrice / <i>Stabilizer bar, bracket</i>		LF45	1402570 1409109
17	730943	Tassello elastico fiss. barra stabilizz. / <i>Rubber buffer</i>	ø int. / inn. 25	LF45	1401850

BILANCIERE / EQUALIZER ASSY

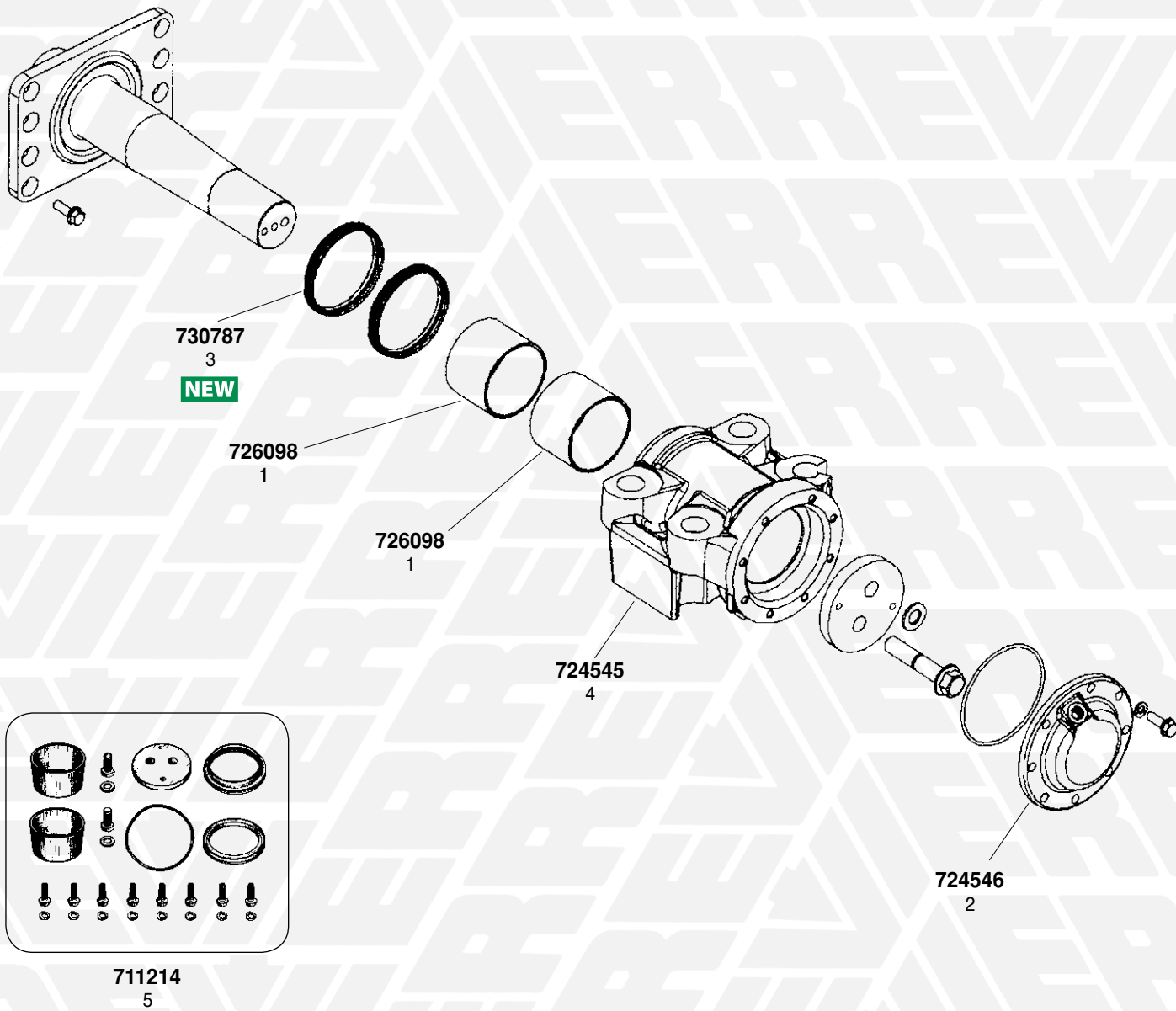
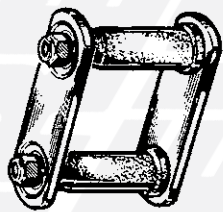


FIG. ITEM	RIF. ERREVI ERREVI REF.	DESCRIZIONE PARTICOLARI DESCRIPTION		TIPO VEHICLE MODEL	RIF. ORIG. ORIG. REF.
BILANCIERE / EQUALIZER ASSY					
1	726098	Boccola supporto bilanciere / <i>Bush</i>	∅ 72x78x55	75CF - 85CF - 95XF CF75 - CF85 - XF95 - XF105	0653262
2	724546	Coperchio per supporto centrale bilanciere / <i>Trunnion cover</i>		75CF - 85CF - 95XF CF75 - CF85 - XF95 - XF105	0653261
3	730787	Paraolio interno / <i>Seal ring, inner</i>	∅ 74,5x94x18	75CF - 85CF - 95XF CF75 - CF85 - XF95 - XF105	1643829
4	724545	Supporto centrale bilanciere / <i>Trunnion</i>		75CF - 85CF - 95XF CF75 - CF85 - XF95 - XF105	0073259
5	711214	Serie completa revisione bilanciere (1 sola PARTE) <i>Equalizer repair kit (SINGLE)</i>		75CF - 85CF - 95XF CF75 - CF85 - XF95 - XF105	0653262S

1



724647
1



2 - 721599 ϕ 10x95
3 - 721217 ϕ 10x120



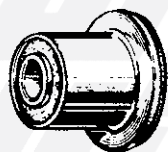
4 - 722000 ϕ 12x70x185
5 - 722689 ϕ 14x70x200



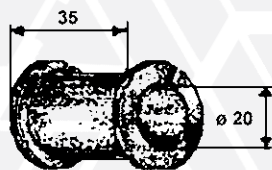
6 - 722733 ϕ 14x80x80
7 - 722219 ϕ 14x80x100

2

SOSPENSIONE ANTERIORE / FRONT SUSPENSION



8 - 730210 ϕ 37x57x43
9 - 730211 ϕ 29x52x34
10 - 730212 ϕ 32x52x34
11 - 730213 ϕ 32x52x43
12 - 730214 ϕ 29x52x44



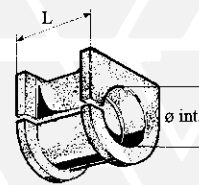
730273
13



730335
14

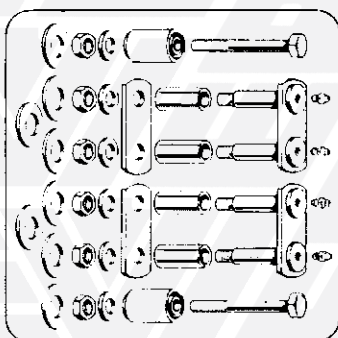


730928
15

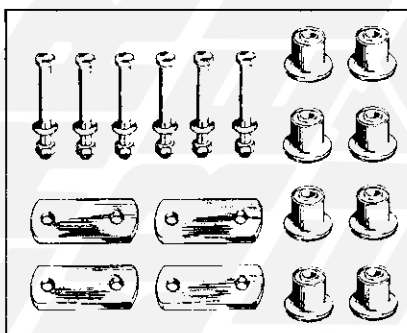


730342
16

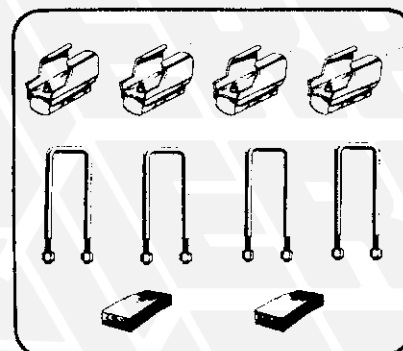
SOSPENSIONE POSTERIORE / REAR SUSPENSION



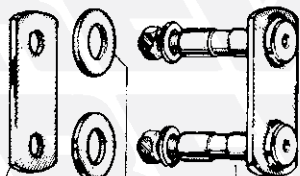
711020
17



711286
18



711340
19



724729
33



726294
35

724623
20



724730
34



725647
30



725550
31



727066
32



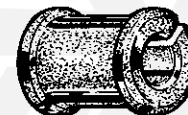
730117
21



730091
22



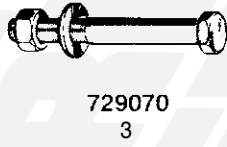
23 - 730334 ϕ 16x38x40
24 - 730344 ϕ 18x38x40
25 - 730332 ϕ 20x38x40
26 - 730275 ϕ 22x38x40
27 - 730324 ϕ 24x38x40



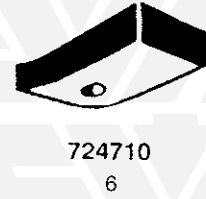
28 - 730386
29 - 730387

FIG. ITEM	RIF. ERREVI ERREVI REF.	DESCRIZIONE PARTICOLARI DESCRIPTION		TIPO VEHICLE MODEL	RIF. ORIG. ORIG. REF.
<div style="display: flex; align-items: center;"> <div style="font-size: 2em; margin-right: 10px;">1</div> <div> <h2 style="margin: 0;">FIAT-IVECO</h2> <h3 style="margin: 0;">DUCATO</h3> </div> </div>					
1	724647	Biscottino compl. di piastra / <i>Shackle c/w plate</i>			7763866 4479223 4015357
2	721599	Bullone centrale post. c/dado / <i>Centre bolt c/w nut</i>	ø10x95 T./H 20x6		-
3	721217	Bullone centrale post. c/dado / <i>Centre bolt c/w nut</i>	ø10x120 T./H 20x6		-
4	722000	Staffa post. Tonda Piatta c/dadi 1ª Serie / <i>U bolt c/w nuts</i>	ø 12x70x185		-
5	722689	Staffa post. Tonda Piatta c/dadi U. Tipo / <i>U bolt c/w nuts</i>	ø 14x70x200		-
6	722733	Staffa post. Quadra c/dadi / <i>U bolt c/w nuts</i>	ø 14x80x80		-
7	722219	Staffa balestra QUADRA c/dadi / <i>U bolt c/w nuts</i>	ø 14x80x100		-
<div style="display: flex; align-items: center;"> <div style="font-size: 2em; margin-right: 10px;">2</div> <div> <h2 style="margin: 0;">IVECO</h2> <h3 style="margin: 0;">DAILY-GRINTA (30.8-30.9-32.8-35.8-40.8)</h3> <h3 style="margin: 0;">NEW DAILY (30.8 - 35.8 - 40.8)</h3> <h3 style="margin: 0;">TURBO DAILY (30.10 - 35.10 - 35.12 - 40.10 - 45.10 - 49.10 - 49.12)</h3> <h4 style="margin: 0;">SOSPENSIONE ANTERIORE / FRONT SUSPENSION</h4> <h4 style="margin: 0;">(TRAVERSA / CROSS MEMBER)</h4> </div> </div>					
8	730210	Boccola elastica - U. Serie / <i>Rubber bush</i>	ø 37x57x43	NEW DAILY - TURBO DAILY	504277460 93810239
9	730211	Boccola elastica - 1ª Serie / <i>Rubber bush</i>	ø 29x52x34	DAILY-GRINTA	1391347
10	730212	Boccola elastica - 2ª Serie / <i>Rubber bush</i>	ø 32x52x34	DAILY-GRINTA	1391348
11	730213	Boccola elastica - U. Serie / <i>Rubber bush</i>	ø 32x52x43	NEW DAILY - TURBO DAILY	93807641
12	730214	Boccola elastica - U. Serie / <i>Rubber bush</i>	ø 29x52x44	NEW DAILY - TURBO DAILY	504277459 93807640
13	730273	Boccola elastica fiss. barra stabilizzatrice / <i>Rubber bush</i>	ø 20x48x35	NEW DAILY - TURBO DAILY 35.11 - 49.11 DAILY CNG	93802248
14	730335	Boccola elastica fiss. barra stabilizzatrice / <i>Rubber bush</i>	ø 35 x 34,5	59.12 TURBODAILY - 59.11 DAILY CNG	8585819
15	730928	Tampone paracolpo / <i>Rubber pad</i>		NEW DAILY 30.8 - 35.8/10 - 45.10 - 49.10 TURBO DAILY 30.10 - 35.10/12 - 49.10/12 DAILY CNG 35.11-49.11-59.11	93803299
16	730342	Tassello elastico fiss. barra stabilizzatrice / <i>Rubber buffer</i>	ø 32 x 70	49.12 TURBODAILY	8558110
<h4 style="text-align: center;">SOSPENSIONE POSTERIORE / REAR SUSPENSION</h4>					
17	711020	Complessivo revisione balestre / <i>Spring repair kit</i>		DAILY-GRINTA	-
18	711286	Complessivo revisione balestre / <i>Spring repair kit</i>		NEW DAILY - TURBO DAILY	-
19	711340	Complessivo applicazione balestrini c/ supporti da saldare <i>Helper spring repair kit (welded type)</i>		30.8-32.8-35.8-40.8-30.10-35.10 40.10	-
20	724623	Biscottino completo 1ª Serie / <i>Shackle assy</i>		DAILY-GRINTA - TURBO DAILY	93802559
21	730117	Boccola elastica (lato ant.) 1ª Serie / <i>Rubber bush (front end)</i>	ø 16x38,6x72	DAILY-GRINTA - TURBO DAILY	93800193
22	730091	Boccola elastica balestra e supporto U.T. / <i>Rubber bush</i>	ø 16x40x35	NEW DAILY - TURBO DAILY	93808935
23	730334	Boccola elastica braccio oscillante / <i>Rubber bush</i>	ø 16x32/38x40	DAILY - NEW DAILY - TURBODAILY	93803960
24	730344	Boccola elastica braccio oscillante / <i>Rubber bush</i>	ø 18x32/38x40	NEW DAILY - TURBO DAILY DAILY CNG	8581022
25	730332	Boccola elastica braccio oscillante / <i>Rubber bush</i>	ø 20x32/38x40	40.8 DAILY - DAILY DUTY NEW DAILY - TURBO DAILY	93802631
26	730275	Boccola elastica braccio oscillante / <i>Rubber bush</i>	ø 22x38x40	NEW DAILY - TURBO DAILY	93801624
27	730324	Boccola elastica braccio oscillante / <i>Rubber bush</i>	ø 24x38x40	NEW DAILY - TURBO DAILY DAILY DUTY - DAILY CNG	93801623
28	730386	Boccola elastica fissaggio barra stabilizzatrice / <i>Rubber bush</i>	ø 26x57x62	TURBODAILY 59.12	93814617
29	730387	Boccola elastica fissaggio barra stabilizzatrice / <i>Rubber bush</i>	ø 28x57x62	TURBODAILY 59.12	93814618
30	725647	Boccola (lato post.) 1ª Serie / <i>Spring eye bush (rear end)</i>	ø 38x24x59	DAILY-GRINTA	93802560
31	725550	Boccola (lato post.) U.T. / <i>Spring bush (rear end)</i>	ø 24x30x60	DAILY-GRINTA	93804949 93806388
32	727066	Distanziale per boccola / <i>Distance piece</i>	ø 16x24x40	NEW DAILY - TURBO DAILY DAILY DUTY - DAILY CNG	93801625
33	724729	Piastra biscottino / <i>Shackle plate</i>		DAILY-GRINTA	93802557
34	724730	Piastra biscottino / <i>Shackle plate</i>		NEW DAILY - TURBO DAILY	93808940
35	726294	Rondella biscottino 1ª Serie / <i>Thrust washer</i>	ø 24x50x3	DAILY-GRINTA - TURBO DAILY	93804900

SOSPENSIONE POSTERIORE / REAR SUSPENSION



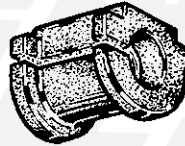
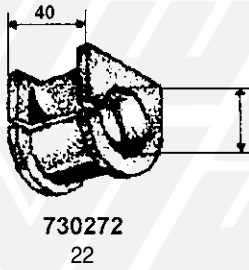
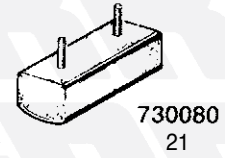
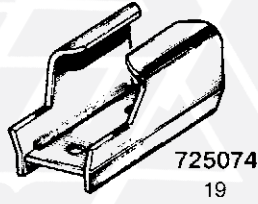
5 - 721217 \varnothing 10x120



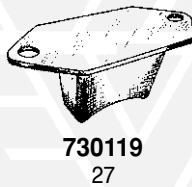
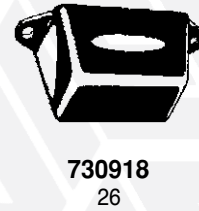
- 8 - 722555 \varnothing 14x60x140
- 9 - 722556 \varnothing 14x60x150
- 10 - 722557 \varnothing 14x60x160
- 11 - 722558 \varnothing 14x60x180
- 12 - 722559 \varnothing 14x60x200



- 14 - 722735 \varnothing 16x60x140
- 15 - 722679 \varnothing 16x60x150
- 16 - 722744 \varnothing 16x60x160
- 17 - 722685 \varnothing 16x60x180
- 18 - 722686 \varnothing 16x60x200



- 24 - 730331 \varnothing 20x40
- 25 - 730276 \varnothing 22x40

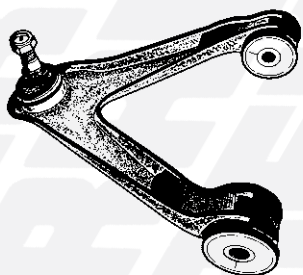


NEW

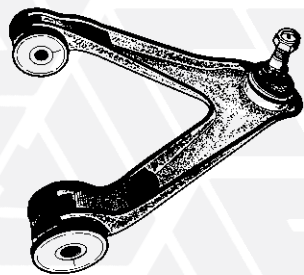


FIG. ITEM	RIF. ERREVI ERREVI REF.	DESCRIZIONE PARTICOLARI DESCRIPTION		TIPO VEHICLE MODEL	RIF. ORIG. ORIG. REF.
<p>DAILY-GRINTA (30.8-30.9-32.8-35.8-40.8) NEW DAILY (30.8 - 35.8 - 40.8) TURBO DAILY (30.10 - 35.10 - 35.12 - 40.10) (45.10 - 49.10 - 49.12)</p> <p>SOSPENSIONE POSTERIORE / REAR SUSPENSION</p>					
1	730977	Boccola elastica barra stabilizzatrice post. <i>Rear rubber bush, stabilizer bar</i>	∅ 36x42x62	TURBODAILY (96) 59.12 TURBODAILY 59.12	93817505
2	730978	Boccola elastica barra stabilizzatrice post. <i>Rear rubber bush, stabilizer bar</i>	∅ 32x46x62	TURBODAILY (96) 49.10 - 49.12 TURBODAILY 49.12 DAILY 65C13	93819387
3	729070	Bullone fissaggio (lato ant.) / <i>Spring bolt (front end)</i>	M16x1,5 L=110		16635533 11369621
4	721599	Bullone centrale c/dado / <i>Centre bolt c/w nut</i>	∅ 10x95 T/H 20x6	35.10 - 35.12 - 40.10 - 49.10	8588988
5	721217	Bullone centrale c/dado / <i>Centre bolt c/w nut</i>	∅ 10x120 T/H 20x6	35.10 - 35.12 - 40.10 - 49.10	-
6	724710	Distanziale tra balestra e balestrino / <i>Distance piece</i>			-
7	722011	Staffa QUADRA c/dadi / <i>U bolt c/w nuts</i>	∅ 14x60x130		93800191
8	722555	Staffa QUADRA c/dadi / <i>U bolt c/w nuts</i>	∅ 14x60x140		-
9	722556	Staffa QUADRA c/dadi / <i>U bolt c/w nuts</i>	∅ 14x60x150		-
10	722557	Staffa QUADRA c/dadi / <i>U bolt c/w nuts</i>	∅ 14x60x160		-
11	722558	Staffa QUADRA c/dadi / <i>U bolt c/w nuts</i>	∅ 14x60x180		-
12	722559	Staffa QUADRA c/dadi / <i>U bolt c/w nuts</i>	∅ 14x60x200		-
13	722678	Staffa QUADRA c/dadi / <i>U bolt c/w nuts</i>	∅ 16x60x130	TURBODAILY	8585336
14	722735	Staffa QUADRA c/dadi / <i>U bolt c/w nuts</i>	∅ 16x60x140	TURBODAILY	93810549
15	722679	Staffa QUADRA c/dadi / <i>U bolt c/w nuts</i>	∅ 16x60x150	TURBODAILY	-
16	722744	Staffa QUADRA c/dadi / <i>U bolt c/w nuts</i>	∅ 16x60x160	TURBODAILY	-
17	722685	Staffa QUADRA c/dadi / <i>U bolt c/w nuts</i>	∅ 16x60x180	TURBODAILY	-
18	722686	Staffa QUADRA c/dadi / <i>U bolt c/w nuts</i>	∅ 16x60x200	TURBODAILY	-
19	725074	Supporto balestrino da saldare / <i>Helper spring bracket (welded type)</i>			-
20	725059	Supporto balestrino da imbullonare (basso) <i>Helper spring bracket (low)</i>		DAILY-GRINTA 30.8/9-32.8-35.8 40.8 NEW DAILY 30.8 - 35.8 - 40.8 TURBO DAILY 30.10 - 35.10/12 40.10 - 45.10 - 49.10 - 49.12	
21	730080	Tassello in gomma supporto balestrino / <i>Helper spring buffer</i>			-
22	730272	Tassello in gomma per barra stabilizzatrice / <i>Rubber buffer</i>	∅ 18x40	NEW DAILY - TURBO DAILY 35.11 - 49.11 DAILY CNG	8581021
23	730333	Tassello elastico fiss. barra stabilizzatrice / <i>Rubber buffer</i>	∅ 16x40	DAILY - NEW DAILY TURBO DAILY	93803961
24	730331	Tassello elastico fiss. barra stabilizzatrice / <i>Rubber buffer</i>	∅ 20x40	DAILY - NEW DAILY TURBO DAILY - DAILY CNG	93802629
25	730276	Tassello in gomma per barra stabilizzatrice / <i>Rubber buffer</i>	∅ 22x40	45.10 - 49.10 NEW DAILY 49.12 TURBODAILY	93801556
26	730918	Tassello paracolpi / <i>Rubber buffer</i>		DAILY-NEW DAILY-NEW DAILY (96) TURBO DAILY - TURBO DAILY (96)	93800197 8586052
27	730119	Tassello paracolpi, posteriore / <i>Rubber buffer, rear</i>		DAILY - NEW DAILY - TURBO DAILY	93803992 503642506
28	713088	Testina a snodo bloccaggio bracci / <i>Ball joint</i>		30.8 - 35.8 - TURBO DAILY (96) NEW DAILY (96)	500310933 93802209
29	713242	Testina a snodo bloccaggio bracci / <i>Ball joint</i>		40.8 Restyling - TURBO DAILY	500337201 8580735

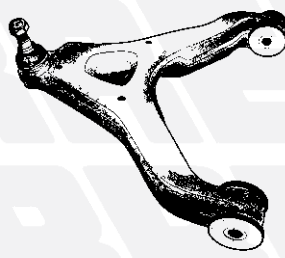
SOSPENSIONE ANTERIORE / FRONT SUSPENSION



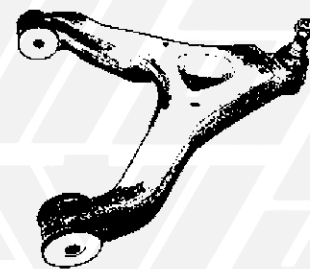
727411
1



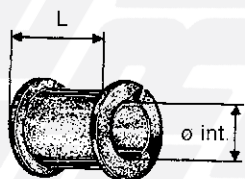
727410
2



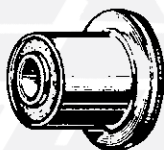
727413
3



727412
4



5 - 730273 \varnothing 20x35
6 - 730335 \varnothing 35x34,5



7 - 730210 \varnothing 37x57x43



730584
8



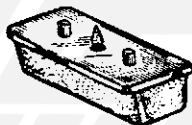
730391
9



730051
10
NEW



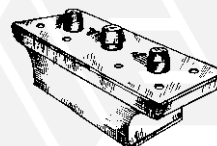
712572
11
NEW



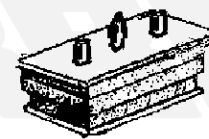
730312
13



730313
14



730098
15
NEW



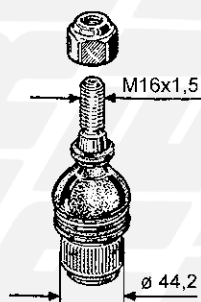
730097
16
NEW



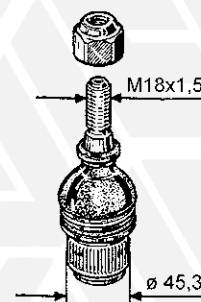
730928
12



713088
17



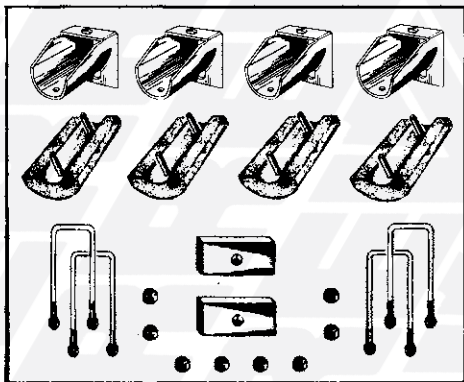
713110
18



713111
19

FIG. ITEM	RIF. ERREVI ERREVI REF.	DESCRIZIONE PARTICOLARI DESCRIPTION		TIPO VEHICLE MODEL	RIF. ORIG. ORIG. REF.
DAILY 2000 - 2006 - 2009 - 2012 - 2016					
SOSPENSIONE ANTERIORE / FRONT SUSPENSION					
1	727411	Braccio oscillante superiore DX / <i>Upper swing arm, RH</i>		35C... - 35S...	500379802 42551297 500344888 500334713
2	727410	Braccio oscillante superiore SX / <i>Upper swing arm, LH</i>		35C... - 35S...	500379801 42551296 500344887 500334714
3	727413	Braccio oscillante inferiore DX / <i>Lower swing arm, RH</i>		35C... - 35S...	500334716 42551289 500334486
4	727412	Braccio oscillante inferiore SX / <i>Lower swing arm, LH</i>		35C... - 35S...	500334717 42551290 500334487
5	730273	Boccola elastica fiss. barra stabilizzatrice / <i>Rubber bush</i>	∅ 20x48x35	35C... - 40C... - 50C...	93802248
6	730335	Boccola elastica fiss. barra stabilizzatrice / <i>Rubber bush</i>	∅ 35 x 34,5	65C... - 70C...	8585819
7	730210	Boccola elastica - U. Serie / <i>Rubber bush</i>	∅ 37x57x43	35C... - 50C...	504277460 93810239
8	730584	Boccola elastica braccio oscillante <i>Silentblock</i>	∅ 28x51x25	35C... - 35S...	504039506 504086381
9	730391	Boccola elastica braccio oscillante / <i>Silentblock</i>	∅ 33x65x35	65C...	500350342
10	730051	Paracolpo balestra anteriore / <i>Rubber pad, front</i>		DAILY 2006 35S12 DAILY 2009 35S11 - 35S12	500340498
11	712572	Supporto barra stabilizzatrice c/silentblock ant. <i>Stabilizer bar brakel c/w silentblock, front</i>	∅ int. 11/18 L= 100 mm	DAILY 35S9/S10/S11/S12/S13/S15/S17	500336363
12	730928	Tampone paracolpo / <i>Rubber pad</i>		35C...	93803299
13	730312	Tassello di battuta inf. (tra rinforzo e traversa) <i>Spring buffer, bottom</i>		35C... - 35S...	500306407
14	730313	Tassello di battuta sup. (tra rinforzo e traversa) <i>Spring buffer, top</i>		35C... - 35S...	504060027 500362729
15	730098	Tassello di battuta inferiore <i>Spring buffer, bottom</i>		DAILY 2000 35C9/C13/C11/C15	500316841
16	730097	Tassello di battuta superiore <i>Spring buffer, top</i>		DAILY 2000 35C9/C13/C11/C15	500316838
17	713088	Testina a snodo bloccaggio bracci / <i>Ball joint</i>		35C... - 50C... - 65C...	93804060 500310933
18	713110	Testina per braccio oscillante SUPERIORE <i>Swinging arm ball joint, top</i>	M16x1,5	35C... - 35S...	-
19	713111	Testina per braccio oscillante INFERIORE <i>Swinging arm ball joint, bottom</i>	M18x1,5	35C... - 35S...	-

SOSPENSIONE POSTERIORE / REAR SUSPENSION



711938
2



724710
3



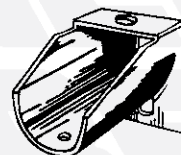
712570
1
NEW



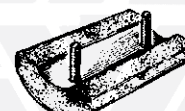
730131
7
NEW



4 - 722558
ø 14x60x180



725083
5



730077
6



8 - 730091 ø 16x40x35
9 - 730348 ø 38x65x33



10 - 730344 ø 18x38x40
11 - 730332 ø 20x38x40
12 - 730275 ø 22x38x40
13 - 730324 ø 24x38x40



15 - 730386
16 - 730387
14 - 730911
17 - 730978



730148
18
NEW



19 - 730388
20 - 730389
21 - 730392



729647
22



727066
23



729455
24



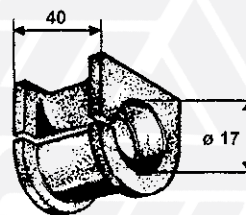
724730
25



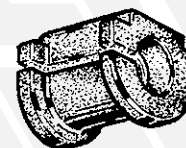
26 - 722678 ø 16x60x130
27 - 722735 ø 16x60x140
28 - 722679 ø 16x60x150
29 - 722744 ø 16x60x160
30 - 722685 ø 16x60x180
31 - 722686 ø 16x60x200



32 - 722745 ø 12x78,5x170
33 - 722746 ø 12x78,5x190



730272
37



38 - 730331 ø 20x40
39 - 730276 ø 22x40



NEW 34 - 712573
NEW 35 - 712574
NEW 36 - 712575



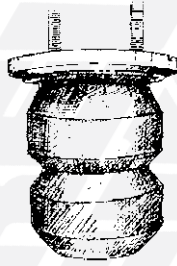
730918
40



730119
41
NEW

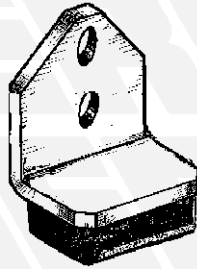
FIG. ITEM	RIF. ERREVI ERREVI REF.	DESCRIZIONE PARTICOLARI DESCRIPTION		TIPO VEHICLE MODEL	RIF. ORIG. ORIG. REF.
DAILY 2000 - 2006 - 2009 - 2012 - 2016					
SOSPENSIONE POSTERIORE / REAR SUSPENSION					
1	712570	Barra di torsione superiore con silentblock <i>Upper torsion bar c/w silentblock</i>	L= 600 mm	DAILY 2006 - 2009 - 2012 - 2016 35S...	500315608
2	711938	Complessivo applicazione balestrino composto da: Helper spring repair kit, inclusive of:		35C...	-
3	724710	(2) Distanziale balestra e balestrino / <i>Distance piece</i>		35C...	-
4	722558	(4) Staffa QUADRA c/dadi / <i>U bolt c/w nuts</i>	ø 14x60x180	35C...	-
5	725083	Supporto balestrino (versione da imbullonare) <i>Helper spring bracket (to fit with bolt)</i>		35C... - 50C...	-
6	730077	(4) Tassello in gomma supporto balestrino / <i>Helper spring buffer</i> (8) Dado autobloccante / <i>Nyloc nut</i>	M8x1,25	35C... 35C...	- -
7	730131	Boccola elastica barra di torsione <i>Torsion bar silentblock</i>	ø 16,5x50x45/52	DAILY 2006 - 2009 - 2012 - 2016 35S11/S12/S13/S14/S15/S17/S18	500323279
8	730091	Boccola elastica balestra e supporto / <i>Rubber bush</i>	ø 16x40x35	35C... - 40C... - 50C...	93808935
9	730348	Boccola elastica / <i>Rubber bush</i>	ø 38x65x33	65C...	500350343
10	730344	Boccola elastica braccio oscillante / <i>Rubber bush</i>	ø 18x32/38x40	35C... - 40C... - 50C...	8581022
11	730332	Boccola elastica braccio oscillante / <i>Rubber bush</i>	ø 20x32/38x40	35S... - 50C...	93802631
12	730275	Boccola elastica braccio oscillante / <i>Rubber bush</i>	ø 22x32/38x40	35C... - 40C... - 50C...	93801624
13	730324	Boccola elastica braccio oscillante / <i>Rubber bush</i>	ø 24x32/38x40	35C... - 35S... - 40C... - 50C...	93801623
14	730911	Boccola elastica fissaggio barra stabilizzatrice / <i>Rubber bush</i>	ø 24x46x62	35S... - 55S...	93814505
15	730386	Boccola elastica fissaggio barra stabilizzatrice / <i>Rubber bush</i>	ø 26x57x62	65C... - 70C...	93814617
16	730387	Boccola elastica fissaggio barra stabilizzatrice / <i>Rubber bush</i>	ø 28x57x62	65C... - 70C...	93814618
17	730978	Boccola elastica barra stabilizzatrice post. <i>Rear rubber bush, stabilizer bar</i>	ø 32x46x62	65C...	93819387
18	730148	Boccola elastica barra stabilizzatrice <i>Stabilizer bar bush</i>	ø 12x25x18	DAILY 2006 - 2009 - 2012 35C... - 35S... - 50C... - 65C...	500326957
19	730388	Boccola balestra / <i>Spring bush</i>	ø 16,5x40x70	35C... - 40C... - 50C...	504112266
20	730389	Boccola balestra / <i>Spring bush</i>	ø 16,5x40x78	65C... - 70C...	504112267
21	730392	Boccola balestra / <i>Spring bush</i>	ø 16,5x40x87	29L - 35S...	504112265 99469085
22	729647	Dado perno occhio balestra e fiss. piastra biscottino / <i>Spring pin nut</i>	M16x2	35C... - 40C... - 50C...	16984631
23	727066	Distanziale per boccola / <i>Distance piece</i>	ø 16x24x40	29L - 35C... - 40C... - 50C...	93801625
24	729455	Perno occhio balestra e fiss. piastra biscottino / <i>Spring pin</i>	ø 16x110	35C... - 40C... - 50C...	16635534
25	724730	Piastra biscottino / <i>Shackle plate</i>		35C... - 40C... - 50C...	93808940
26	722678	Staffa QUADRA c/dadi / <i>U bolt c/w nuts</i>	ø 16x60x130	50C...	8585336
27	722735	Staffa QUADRA c/dadi / <i>U bolt c/w nuts</i>	ø 16x60x140	50C...	93810549
28	722679	Staffa QUADRA c/dadi / <i>U bolt c/w nuts</i>	ø 16x60x150	50C...	-
29	722744	Staffa QUADRA c/dadi / <i>U bolt c/w nuts</i>	ø 16x60x160	50C...	-
30	722685	Staffa QUADRA c/dadi / <i>U bolt c/w nuts</i>	ø 16x60x180	50C...	-
31	722686	Staffa QUADRA c/dadi / <i>U bolt c/w nuts</i>	ø 16x60x200	50C...	-
32	722745	Staffa balestra TONDA c/dadi / <i>U bolt c/w nuts</i>	ø 12x78,5x170	35S...	504083564 500330951
33	722746	Staffa balestra TONDA c/dadi / <i>U bolt c/w nuts</i>	ø 12x78,5x190	35S...	504083563 500341762
34	712573	Supporto barra stabilizzatrice c/silentblock <i>Stabilizer bar braket c/w silentblock</i>	ø int. 11/20 L= 100 mm	DAILY 35S...	500336364
35	712574	Supporto barra stabilizzatrice c/silentblock <i>Stabilizer bar braket c/w silentblock</i>	ø int. 11/22 L= 100 mm	DAILY 2006 - 2009 - 2012 - 2016 35S...	500336365
36	712575	Supporto barra stabilizzatrice c/silentblock <i>Stabilizer bar braket c/w silentblock</i>	ø int. 23,5 L= 100 mm	DAILY 2009 - 2012 - 2016 35S... - 70C...	500336366
37	730272	Tassello in gomma per barra stabilizzatrice / <i>Rubber buffer</i>	ø 18x40	35C... - 35S... - 40C... - 50C...	8581021
38	730331	Tassello in gomma per barra stabilizzatrice / <i>Rubber buffer</i>	ø 20x40	35S... - 50C...	93802629
39	730276	Tassello in gomma per barra stabilizzatrice / <i>Rubber buffer</i>	ø 22x40	35C... - 35S... - 50C...	93801556
40	730918	Tassello paracolpi / <i>Rubber buffer</i>		35C... - 40C... - 50C...	93800197 8586052
41	730119	Tassello paracolpi / <i>Rubber buffer</i>			93803992 503642506

SOSPENSIONE POSTERIORE / REAR SUSPENSION



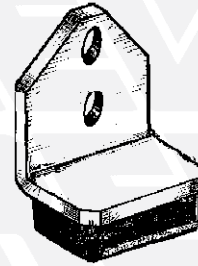
730110
2

NEW



730111
3

NEW



730149
4

NEW



NEW 5 - 730860

NEW 6 - 730861

NEW 7 - 730862



NEW 8 - 730863

NEW 9 - 730864

NEW 10 - 730865



712576
11

NEW



712571
12

NEW

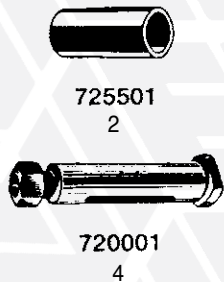


730139
1

NEW

FIG. ITEM	RIF. ERREVI ERREVI REF.	DESCRIZIONE PARTICOLARI DESCRIPTION		TIPO VEHICLE MODEL	RIF. ORIG. ORIG. REF.
DAILY 2000 - 2006 - 2009 - 2012 - 2016					
SOSPENSIONE POSTERIORE / REAR SUSPENSION					
1	730139	Boccola elastica tirante sospensione <i>Suspension rod silentblock</i>	∅ 10x40x28/34	DAILY 2006 - 2009 - 2012 - 2016 35S11/S12/S13/S14/S15/S17/S18	500323280
2	730110	Tampone paracolpo balestra / <i>Rubber buffer</i>		DAILY 2006 - 2009 - 2012 35S...	504237430 504060351
3	730111	Tassello paracolpi / <i>Rubber buffer</i>		DAILY 2000 - 2006 - 2009 - 2012 - 2016 35S...	99470924
4	730149	Tassello paracolpi / <i>Rubber buffer</i>		DAILY 2000 - 2006 - 2009 - 2012 - 2016 35S...	500362468
5	730860	Tirante barra stabilizzatrice c/silentblock <i>Stabilizer bar rod</i>	∅ int. 16 L= 130	DAILY 35S...	504092612
6	730861	Tirante barra stabilizzatrice c/silentblock <i>Stabilizer bar rod</i>	∅ int. 16/18 L= 130	DAILY 2006 - 2009 - 2012 35S...	504092613
7	730862	Tirante barra stabilizzatrice c/silentblock <i>Stabilizer bar rod</i>	∅ int. 16/22 L= 130	DAILY 2006 - 2009 - 2012 35S...	504092615
8	730863	Tirante barra stabilizzatrice c/silentblock <i>Stabilizer bar rod</i>	∅ int. 16 L= 180	DAILY 35S...	504092618
9	730864	Tirante barra stabilizzatrice c/silentblock <i>Stabilizer bar rod</i>	∅ int. 16/18 L= 180	DAILY 2006 - 2009 - 2012 35S...	504092619
10	730865	Tirante barra stabilizzatrice c/silentblock <i>Stabilizer bar rod</i>	∅ int. 16/20 L= 180	DAILY 35S...	504092620
11	712576	Tirante stabilizzatore, sosp. Pneumatica <i>Stabilizer rod, rear air suspension</i>		DAILY 2000 - 2006 - 2009 - 2012 - 2016 35S...	500363065
12	712571	Tirante sospensione con silentblock <i>Suspension rod c/w silentblock</i>	L= 110 mm	DAILY 2006 - 2009 - 2012 - 2016 35S...	500315622

1 SOSPENSIONE POSTERIORE / REAR SUSPENSION



2 SOSPENSIONE ANTERIORE E POSTERIORE / FRONT AND REAR SUSPENSION

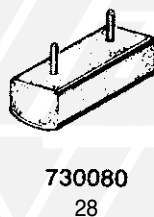
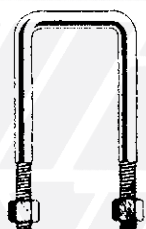
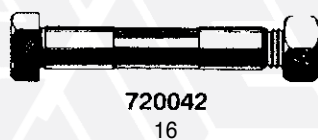
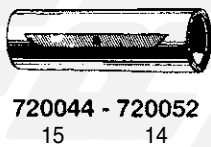
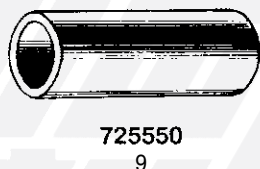
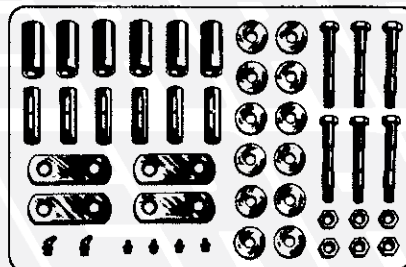
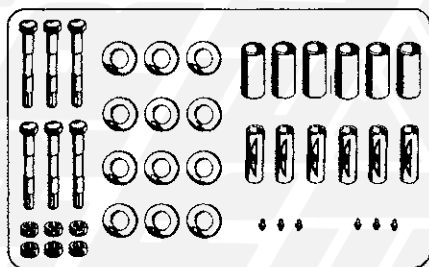
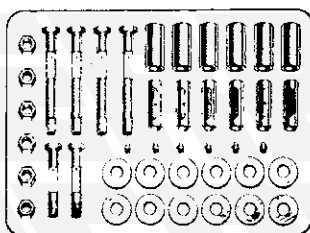


FIG. ITEM	RIF. ERREVI ERREVI REF.	DESCRIZIONE PARTICOLARI DESCRIPTION	TIPO VEHICLE MODEL	RIF. ORIG. ORIG. REF.
<div style="display: flex; align-items: center;"> <div style="font-size: 2em; margin-right: 10px;">1</div> <div> 616N3/4 SOSPENSIONE POSTERIORE / REAR SUSPENSION </div> </div>				
1	724601	Biscottino con boccola / <i>Shackle</i>		547194
2	725501	Boccola balestra e biscottino / <i>Spring eye bush</i>	∅ 18x24x59	542962
3	721606	Bullone centrale c/dado / <i>Centre bolt c/w nut</i>	∅ 10x100 T./H 18x9	-
4	720001	Perno balestra e biscottino c/dado / <i>Spring pin</i>	M14x1,5 ∅18x90	545303
5	726201	Rosetta rasamento / <i>Thrust washer</i>	∅ 18x38x2,5	542963
<div style="display: flex; align-items: center;"> <div style="font-size: 2em; margin-right: 10px;">2</div> <div> 35NC - 40NC - 45NC - 49NC SOSPENSIONE ANTERIORE E POSTERIORE / FRONT AND REAR SUSPENSION </div> </div>				
6	711035	Complessivo revisione balestre ant. 1ª Serie <i>Front spring repair kit, old models</i>	35NC - 40NC	-
7	711027	Complessivo revisione balestre ant. U.T. <i>Front spring repair kit, latest models</i>		-
8	711035	Complessivo revisione balestre post. U.T. <i>Rear spring repair kit, latest models</i>		-
9	725550	Boccola balestra e biscottino / <i>Spring bush</i>	∅ 24x30x60	540978
10	721637	Bullone centrale ant. / <i>Centre bolt c/w nut</i>	∅ 10x110 T./H 17x17	-
11	721606	Bullone centrale post. / <i>Centre bolt c/w nut</i>	∅ 10x120 T./H 18x9	35NC - 40NC - 625N3
12	721608	Bullone centrale post. / <i>Centre bolt c/w nut</i>	∅ 10x140 T./H 18x9	35NC - 40NC - 625N3
13	724710	Distanziale fra balestra e balestrino / <i>Distance piece</i>		-
14	720052	Distanziale perno balestra e biscottino ant. U.T. / <i>Front spring bush</i>	∅ 16x24x59	8562769
15	720044	Distanziale perno balestra e biscottino / <i>Spring bush</i>	∅ 16x24x64	542606
16	720042	Perno balestra e biscottino / <i>Spring pin</i>	∅ 16x100	8565908
17	724634	Piastra biscottino ant. U.T. / <i>Front spring shackle plate</i>		8562768
18	726241	Rondella rasamento balestra e biscottino / <i>Thrust washer</i>	∅ 24x44x2,5	540980
19	726232	Rondella rasamento ant. U.T. / <i>Front spring thrust washer</i>	∅ 16x44x2,5	8564955
20	722011	Staffa ant. QUADRA con dadi / <i>U bolt c/w nuts</i>	∅ 14x60x130	8558449
21	722555	Staffa ant. QUADRA con dadi / <i>U bolt c/w nuts</i>	∅ 14x60x140	-
22	722556	Staffa ant. QUADRA con dadi / <i>U bolt c/w nuts</i>	∅ 14x60x150	-
23	722557	Staffa ant. QUADRA con dadi / <i>U bolt c/w nuts</i>	∅ 14x60x160	-
24	722581	Staffa post. QUADRA con dadi / <i>U bolt c/w nuts</i>	∅ 16x60x270	8558450
25	722582	Staffa post. QUADRA con dadi / <i>U bolt c/w nuts</i>	∅ 16x60x310	-
26	722583	Staffa post. QUADRA con dadi / <i>U bolt c/w nuts</i>	∅ 16x60x330	-
27	722584	Staffa post. QUADRA con dadi / <i>U bolt c/w nuts</i>	∅ 16x60x350	-
28	730080	Tassello in gomma supporto balestrino / <i>Helper spring buffer</i>		-

SOSPENSIONE ANTERIORE E POSTERIORE / FRONT AND REAR SUSPENSION



711038

1



3 - 721103 \varnothing 14x130 T./Head 24x14



725551

2



720045 - 720046

5

4



720041 - 720043

7

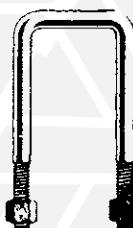
6



726232 - 726241

8

9



10 - 722510 \varnothing 14x70x130

11 - 722511 \varnothing 14x70x140

12 - 722512 \varnothing 14x70x150



13 - 722020 \varnothing 16x70x250

14 - 722021 \varnothing 16x70x270

15 - 722022 \varnothing 16x70x300

16 - 722574 \varnothing 16x70x280

17 - 722576 \varnothing 16x70x330

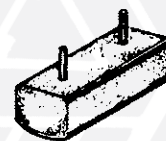
18 - 722577 \varnothing 16x70x350

19 - 722671 \varnothing 18x70x270

20 - 722672 \varnothing 18x70x300

21 - 722673 \varnothing 18x70x325

22 - 722674 \varnothing 18x70x340

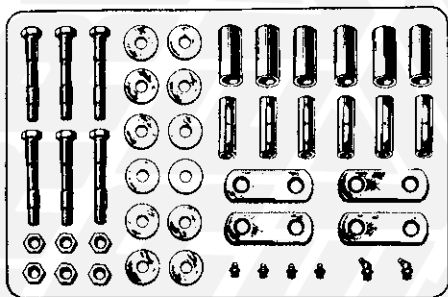


730080

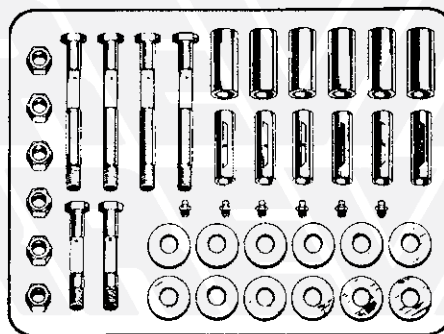
23

FIG. ITEM	RIF. ERREVI ERREVI REF.	DESCRIZIONE PARTICOLARI DESCRIPTION	TIPO VEHICLE MODEL	RIF. ORIG. ORIG. REF.
50NC - 55NC - 65NC - 70NC - 75NC				
SOSPENSIONE ANTERIORE E POSTERIORE / FRONT AND REAR SUSPENSION				
1	711038	Complessivo revisione balestre post. / Rear spring repair kit		-
2	725551	Boccola balestra e biscottino / Spring bush	∅ 24x30x69	542612
3	721103	Bullone centrale post. / Centre bolt c/w nut	∅ 14x130 T/H 24x14	-
4	720046	Distanziale perno ant. / Front spring bush	∅ 16x24x69	8564956 8557041
5	720045	Distanziale perno balestra e biscottino post. / Rear spring bush	∅ 16x24x74	542613
6	720043	Perno balestra e biscottino / Spring pin	∅ 16x116	8565902 8565906 8557043
7	720041	Perno supporto balestra post. / Rear spring pin	∅ 16x160	8565904 8547238
8	726232	Rondella rasamento ant. / Thrust washer, front spring	∅ 16x44x2,5	8564955
9	726241	Rondella rasamento post. / Thrust washer, rear spring	∅ 24x44x2,5	540980
10	722510	Staffa ant. Quadra con dadi / U bolt c/w nuts	∅ 14x70x130	8551566
11	722511	Staffa ant. Quadra con dadi / U bolt c/w nuts	∅ 14x70x140	8560182 8562006
12	722512	Staffa ant. Quadra con dadi / U bolt c/w nuts	∅ 14x70x150	-
13	722020	Staffa post. Quadra con dadi / U bolt c/w nuts	∅ 16x70x250	50NC 8554811
14	722021	Staffa post. Quadra con dadi / U bolt c/w nuts	∅ 16x70x270	50NC -
15	722022	Staffa post. Quadra con dadi / U bolt c/w nuts	∅ 16x70x300	50NC -
16	722574	Staffa post. Quadra con dadi / U bolt c/w nuts	∅ 16x70x280	65NC - 70NC - 75NC 8548738
17	722576	Staffa post. Quadra con dadi / U bolt c/w nuts	∅ 16x70x330	65NC - 70NC - 75NC -
18	722577	Staffa post. Quadra con dadi / U bolt c/w nuts	∅ 16x70x350	65NC - 70NC - 75NC -
19	722671	Staffa post. Quadra con dadi / U bolt c/w nuts	∅ 18x70x270	50/55NC con barra stabilizzatrice 8556310
20	722672	Staffa post. Quadra con dadi / U bolt c/w nuts	∅ 18x70x300	50/55NC con barra stabilizzatrice -
21	722673	Staffa post. Quadra con dadi / U bolt c/w nuts	∅ 18x70x325	65/70/75NC c/barra stabilizzatrice 8556311
22	722674	Staffa post. Quadra con dadi / U bolt c/w nuts	∅ 18x70x340	65/70/75NC c/barra stabilizzatrice -
23	730080	Tassello in gomma per supporto balestrino Helper spring buffer		-

SOSPENSIONE ANTERIORE E POSTERIORE / FRONT AND REAR SUSPENSION



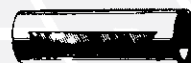
711040
1



711041
2



725551
3



720046
6



4 - 721628 \varnothing 14x120 T./Head h. 28



5 - 721103 \varnothing 14x130 T./Head 24x14



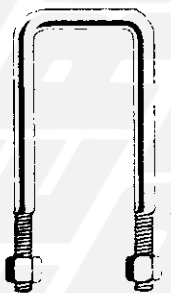
720041 - 720043
7 8



726884
9



12 - 722509 \varnothing 14x70x120
13 - 722510 \varnothing 14x70x130
14 - 722513 \varnothing 14x70x170
15 - 722514 \varnothing 14x70x190



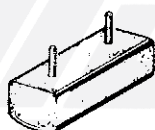
16 - 722020 \varnothing 16x70x250
17 - 722021 \varnothing 16x70x270
18 - 722574 \varnothing 16x70x280
19 - 722022 \varnothing 16x70x300
20 - 722576 \varnothing 16x70x330
21 - 722577 \varnothing 16x70x350
22 - 722578 \varnothing 16x70x370



726232
10



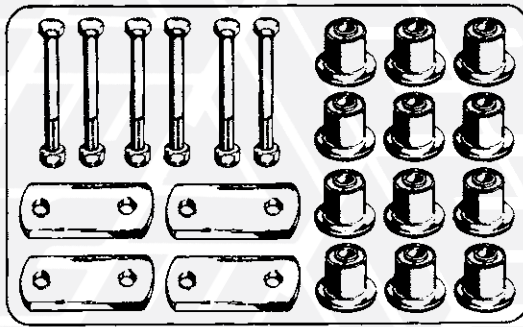
730114
11



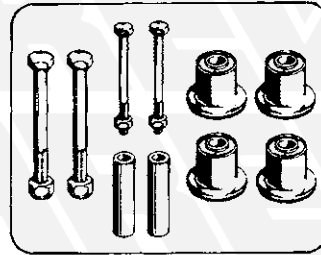
730080
23

FIG. ITEM	RIF. ERREVI ERREVI REF.	DESCRIZIONE PARTICOLARI DESCRIPTION	TIPO VEHICLE MODEL	RIF. ORIG. ORIG. REF.
50.8/F8 - 50.9/F9 - 50.10/F10 - 55.8/F8 55.9/F9 - 55.10/F10 - 60.8/F8 - 60.10/F10 65.10/F10 - 70.10/F10 - 75.10/F10 - 79.10/F10 SOSPENSIONE ANTERIORE E POSTERIORE / FRONT AND REAR SUSPENSION				
1	711040	Complessivo revisione balestre ant. / Front spring repair kit		-
2	711041	Complessivo revisione balestre post. / Rear spring repair kit		-
3	725551	Boccola balestra e biscottino / Spring eye and shackle bush	ø 24x30x69	542612
4	721628	Bullone centrale c/dado u.t. / Centre bolt c/w nut	ø 14x120 T/Head h.28	42072598
5	721103	Bullone centrale post. / Centre bolt c/w nut	ø 14x130 T/H 24x14	-
6	720046	Distanziale perno balestra e biscottino / Spring bush	ø 16x24x69	8564956
7	720041	Perno balestra post. (lato ant.) / Rear spring pin (front end)	ø 16x160	8565904
8	720043	Perno balestra e biscottino / Spring pin	ø 16x116	8565902 8565906
9	726884	Piastra biscottino balestra ant. / Front spring shackle plate		8563921
10	726232	Rondella rasamento balestra e biscottino / Thrust washer	ø 16x44x2,5	8564955
11	730114	Silentblock supporto barra stabilizzatrice post. / Silentblock	ø 20x46x55	4606379
12	722509	Staffa ant. Quadra c/dadi / U bolt c/w nuts	ø 14x70x120	8563357
13	722510	Staffa ant. Quadra c/dadi / U bolt c/w nuts	ø 14x70x130	-
14	722513	Staffa ant. Quadra c/dadi / U bolt c/w nuts	ø 14x70x170	65.10/F10 - 70.10/F10 75.10/F10 - 79.10/F10
15	722514	Staffa ant. Quadra c/dadi / U bolt c/w nuts	ø 14x70x190	65.10/F10 - 70.10/F10 75.10/F10 - 79.10/F10
16	722020	Staffa post. Quadra c/dadi / U bolt c/w nuts	ø 16x70x250	8554811
17	722021	Staffa post. Quadra c/dadi / U bolt c/w nuts	ø 16x70x270	-
18	722574	Staffa post. Quadra c/dadi / U bolt c/w nuts	ø 16x70x280	8548738
19	722022	Staffa post. Quadra c/dadi / U bolt c/w nuts	ø 16x70x300	8564012
20	722576	Staffa post. Quadra c/dadi / U bolt c/w nuts	ø 16x70x330	75.10/F10 - 79.10/F10
21	722577	Staffa post. Quadra c/dadi / U bolt c/w nuts	ø 16x70x350	75.10/F10 - 79.10/F10
22	722578	Staffa post. Quadra c/dadi / U bolt c/w nuts	ø 16x70x370	75.10/F10 - 79.10/F10
23	730080	Tassello in gomma supporto balestrino / Helper spring buffer	(per modifica applicaz. balestrini)	-

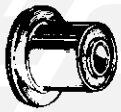
SOSPENSIONE ANTERIORE E POSTERIORE / FRONT AND REAR SUSPENSION



711342
1



711343
2



730190
3



4 - 721228 \varnothing 12x90



5 - 721227 \varnothing 12x150



728980
6



721068
7



729415
8



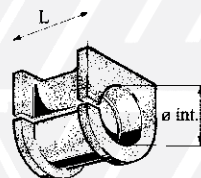
724635
9



10 - 722509 \varnothing 14x70x120
11 - 722510 \varnothing 14x70x130
12 - 722511 \varnothing 14x70x140



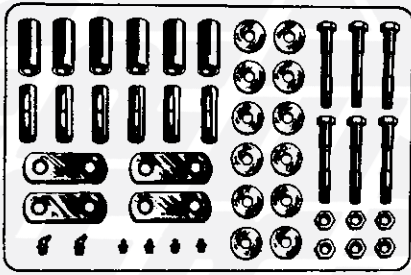
13 - 722574 \varnothing 16x70x280
14 - 722022 \varnothing 16x70x300
15 - 722576 \varnothing 16x70x330
16 - 722577 \varnothing 16x70x350



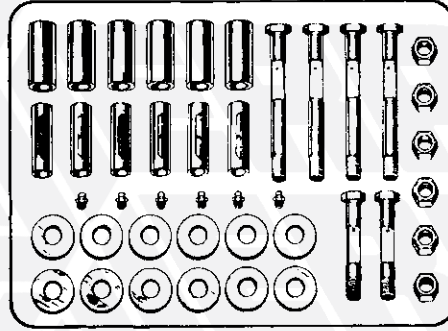
17 - 730338 \varnothing 24x55
18 - 730341 \varnothing 26x60
19 - 730337 \varnothing 28x60
20 - 730339 \varnothing 28x70
21 - 730342 \varnothing 32x70
22 - 730340 \varnothing 34x70

FIG. ITEM	RIF. ERREVI ERREVI REF.	DESCRIZIONE PARTICOLARI DESCRIPTION	TIPO VEHICLE MODEL	RIF. ORIG. ORIG. REF.
50.9 Z - 60.11 TURBO Z - 65.12 TURBO Z 79.14 - 79.14 Z				
SOSPENSIONE ANTERIORE E POSTERIORE FRONT AND REAR SUSPENSION				
1	711342	Complessivo revisione balestre anteriori composto da: 12 boccole elastiche - 6 perni fissaggio balestra - 4 piastre biscottino Front spring repair kit, inclusive of: 12 rubber bushes - 6 spring pins - 4 shackle plates		-
2	711343	Complessivo revisione balestre posteriori composto da: 4 boccole elastiche - 2 perni fissaggio balestra lato anteriore 2 bulloni per distanziale lato posteriore - 2 distanziali Rear spring repair kit, inclusive of: 4 rubber bushes - 2 spring pins - 2 bolts - 2 spring bracket bushes		-
3	730190	Boccola elastica supporto bal. e biscottino ant. e post. / Rubber bush	∅ 16x40x40	8587681
4	721228	Bullone centrale ant. c/dado / Centre bolt c/w nut	∅ 12x90 T/H 24,5x26	-
5	721227	Bullone centrale post. c/dado / Centre bolt c/w nut	∅ 12x150 T/H 24,5x14	65.12 TURBO Z - 79.14 - 79.14Z 8587401
6	728980	Distanziale supporto balestra post. lato post. Rear spring bracket bush (rear end)	∅ 13x22x72	8580341
7	721068	Perno fissaggio balestra e biscottino / Spring pin	M16x1,5 L=100	8597204 16251133
8	729415	Perno distanziale post. lato post. / Rear spring pin (rear end)		15541621
9	724635	Piastra biscottino ant. / Shackle plate, front spring		8587381
10	722509	Staffa ant. Quadra c/dadi / U bolt c/w nuts	∅ 14x70x120	8583357
11	722510	Staffa ant. Quadra c/dadi / U bolt c/w nuts	∅ 14x70x130	-
12	722511	Staffa ant. Quadra c/dadi / U bolt c/w nuts	∅ 14x70x140	-
13	722574	Staffa post. Quadra c/dadi / U bolt c/w nuts	∅ 16x70x280	50.9 Z 8583343
14	722022	Staffa post. Quadra c/dadi / U bolt c/w nuts	∅ 16x70x300	8564012
15	722576	Staffa post. Quadra c/dadi / U bolt c/w nuts	∅ 16x70x330	-
16	722577	Staffa post. Quadra c/dadi / U bolt c/w nuts	∅ 16x70x350	-
17	730338	Tassello elastico fiss. barra stabilizzatrice / Rubber buffer	∅ 24x55	50.9 Z 8557780
18	730341	Tassello elastico fiss. barra stabilizzatrice / Rubber buffer	∅ 26x60	60.11-65.12-79.12 TURBO Z 65.9 Z - 79.14 Z 8581295
19	730337	Tassello elastico fiss. barra stabilizzatrice / Rubber buffer	∅ 28x60	50.9 Z 8563414 8557781
20	730339	Tassello elastico fiss. barra stabilizzatrice / Rubber buffer	∅ 28x70	50.9 Z 8560291
21	730342	Tassello elastico fiss. barra stabilizzatrice / Rubber buffer	∅ 32x70	60.11-65.12-79.12 TURBO Z 65.9 Z - 79.14 Z 8558110
22	730340	Tassello elastico fiss. barra stabilizzatrice / Rubber buffer	∅ 34x70	60.11-65.12-79.12 TURBO Z 65.9 Z - 79.14 Z 8584626

1 SOSPENSIONE ANTERIORE E POSTERIORE / FRONT AND REAR SUSPENSION



711040
1



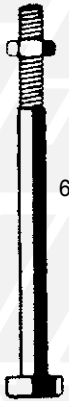
711038 - 711041
2 3



725551
4



5 - 721103 \varnothing 14x130



6 - 721191 \varnothing 14x205



7 - 720045
8 - 720046



9 - 720041
10 - 720043



726884
11



726241 - 726232
12 13



730114
14



15 - 722512 \varnothing 14x70x150
16 - 722513 \varnothing 14x70x170
17 - 722514 \varnothing 14x70x190

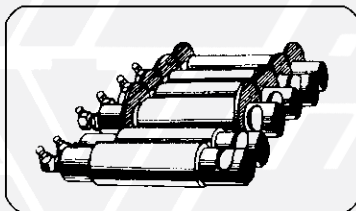


18 - 722576 \varnothing 16x70x330
19 - 722577 \varnothing 16x70x350
20 - 722578 \varnothing 16x70x370

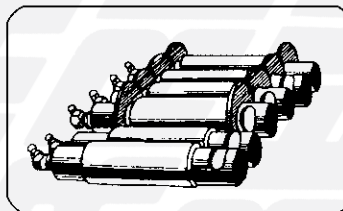


21 - 722675 \varnothing 18x70x360
22 - 722676 \varnothing 18x70x380
23 - 722677 \varnothing 18x70x400

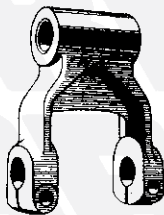
2 SOSPENSIONE ANTERIORE E POSTERIORE / FRONT AND REAR SUSPENSION



711006
24



711012
25



724611
26



27 - 725508 \varnothing 22x29x69
28 - 725509 \varnothing 22x27x75
29 - 725523 \varnothing 24x30x79



30 - 721108 \varnothing 14x260



720011 - 720010
31 32



33 - 726209
34 - 726229



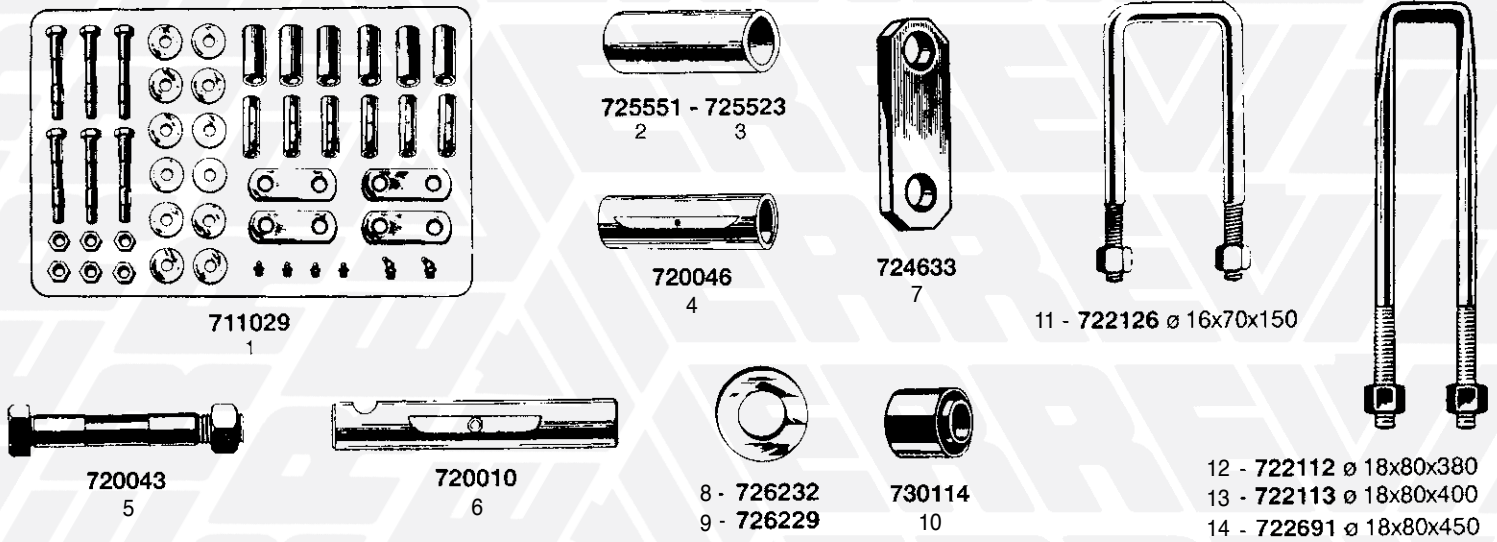
35 - 722121 \varnothing 16x70x160
36 - 722122 \varnothing 16x70x180
37 - 722123 \varnothing 16x70x200



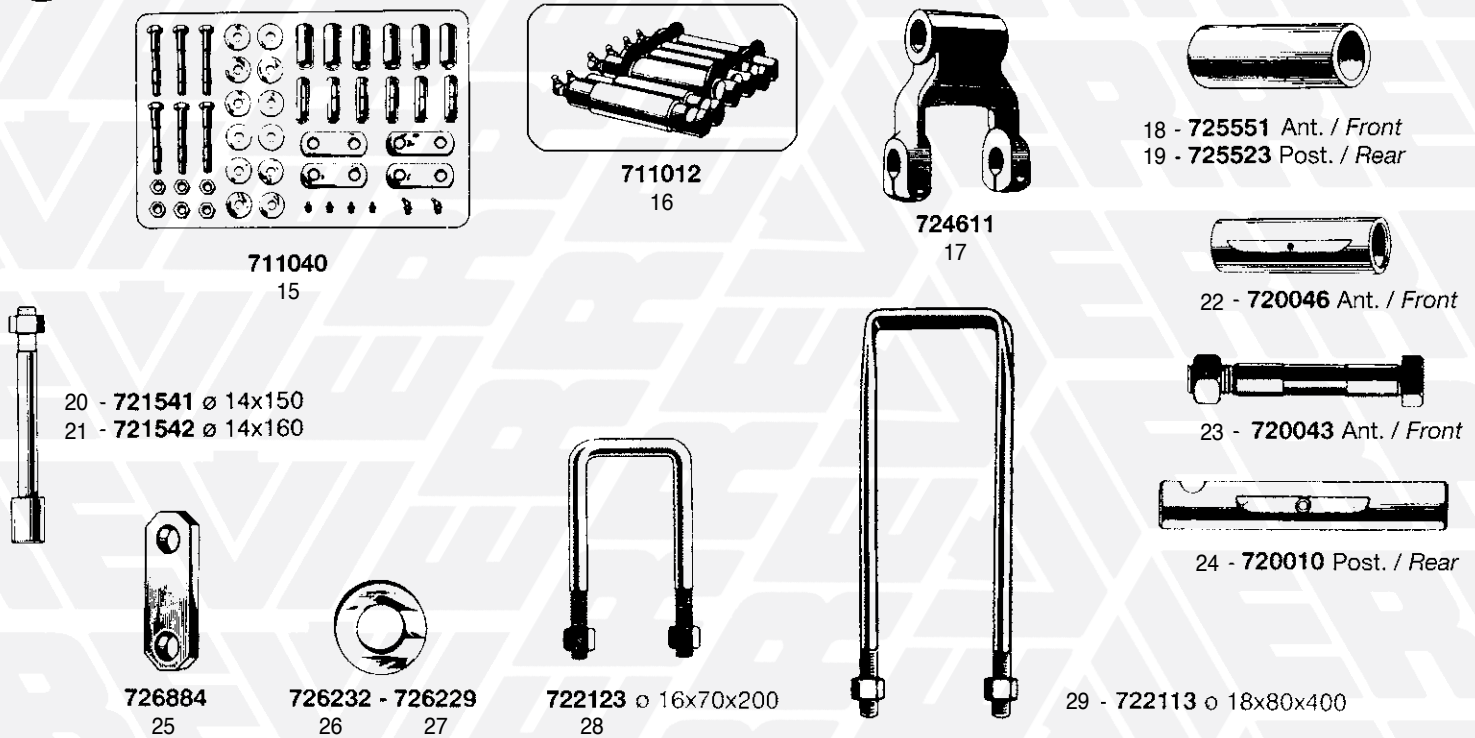
38 - 722111 \varnothing 18x80x360
39 - 722112 \varnothing 18x80x380
40 - 722113 \varnothing 18x80x400

FIG. ITEM	RIF. ERREVI ERREVI REF.	DESCRIZIONE PARTICOLARI DESCRIPTION	TIPO VEHICLE MODEL	RIF. ORIG. ORIG. REF.
1 80NC - 90NC (79.13/F13 - 80.13/F13 - 90.13/F13) SOSPENSIONE ANTERIORE E POSTERIORE / FRONT AND REAR SUSPENSION				
1	711040	Completivo revisione balestre ant. / <i>Front spring repair kit</i>	79.13/F13 - 80.13/F13 - 90.13/F13	-
2	711038	Completivo revisione balestre post. / <i>Rear spring repair kit</i>	80NC - 90NC	-
3	711041	Completivo revisione balestre post. / <i>Rear spring repair kit</i>	79.13/F13 - 80.13/F13 - 90.13/F13	-
4	725551	Boccola balestra e biscottino / <i>Spring eye and shackle bush</i>	∅ 24x30x69	542612
5	721103	Bullone centrale ant. c/dado / <i>Centre bolt c/w nut</i>	∅ 14x130T/H 24x14	80NC - 90NC
6	721191	Bullone centrale post. c/dado / <i>Centre bolt c/w nut</i>	∅ 14x205T/H 24,5x13	8788927
7	720045	Distanziale in acciaio perno balestra e biscottino post. / <i>Rear spring bush</i>	∅ 16x24x74	80NC - 90NC
8	720046	Distanziale in acciaio perno balestra e biscottino / <i>Spring bush</i>	∅ 16x24x69	8564956
9	720041	Perno supporto balestra post. (lato ant.) / <i>Rear spring pin (front end)</i>	∅ 16x160	8565904 8547238
10	720043	Perno balestra e biscottino / <i>Spring pin</i>	∅ 16x116	8565906 8557043
11	726884	Piastra biscottino ant. / <i>Shackle plate, front spring</i>	79.13/F13 - 80.13/F13 - 90.13/F13	8563921
12	726241	Rondella rasamento balestra post. / <i>Thrust washer, rear spring</i>	∅ 24x44x2,5	80NC - 90NC
13	726232	Rondella rasamento balestra e biscottino / <i>Thrust washer</i>	∅ 16x44x2,5	8564955
14	730114	Silentblock supporto barra stabilizzatrice post. / <i>Silentblock</i>	∅ 20x46x55	4606379
15	722512	Staffa ant. Quadra c/dadi / <i>U bolt c/w nuts</i>	∅ 14x70x150	8562007
16	722513	Staffa ant. Quadra c/dadi / <i>U bolt c/w nuts</i>	∅ 14x70x170	-
17	722514	Staffa ant. Quadra c/dadi / <i>U bolt c/w nuts</i>	∅ 14x70x190	-
18	722576	Staffa post. Quadra c/dadi / <i>U bolt c/w nuts</i>	∅ 16x70x330	79.13/F13
19	722577	Staffa post. Quadra c/dadi / <i>U bolt c/w nuts</i>	∅ 16x70x350	80NC - 90NC
20	722578	Staffa post. Quadra c/dadi / <i>U bolt c/w nuts</i>	∅ 16x70x370	8548744 8558994
21	722675	Staffa post. Quadra c/dadi / <i>U bolt c/w nuts</i>	∅ 18x70x360	80.13/F13 - 90.13/F13
22	722676	Staffa post. Quadra c/dadi / <i>U bolt c/w nuts</i>	∅ 18x70x380	8563896 8556325
23	722677	Staffa post. Quadra c/dadi / <i>U bolt c/w nuts</i>	∅ 18x70x400	80.13/F13 - 90.13/F13
2 100NC - 110NC - 130NC (100.14) SOSPENSIONE ANTERIORE E POSTERIORE / FRONT AND REAR SUSPENSION				
24	711006	Completivo revisione balestre ant. / <i>Front spring repair kit</i>		-
25	711012	Completivo revisione balestre post. / <i>Rear spring repair kit</i>		-
26	724611	Biscottino balestra post. / <i>Rear shackle</i>		8584386 4517216
27	725508	Boccola balestra ant. / <i>Front spring bush</i>	∅ 22x29x69	4501305 4636089
28	725509	Boccola biscottino ant. / <i>Front shackle bush</i>	∅ 22x27x75	4501309
29	725523	Boccola balestra e biscottino post. / <i>Rear spring and shackle bush</i>	∅ 24x30x79	4517218
30	721108	Bullone centrale post. / <i>Centre bolt c/w nut</i>	∅ 14x260T/H 25x9	-
31	720011	Perno balestra e biscottino ant. / <i>Front spring pin</i>	∅ 22x124	4610496 4501310
32	720010	Perno balestra e biscottino post. / <i>Rear spring pin</i>	∅ 24x130	8581881 4517219
33	726209	Rondella rasamento balestra ant. / <i>Thrust washer, front</i>	∅ 22x50x3	4501311
34	726229	Rondella rasamento balestra post. / <i>Thrust washer, rear</i>	∅ 24x45x3	4517220
35	722121	Staffa ant. Quadra c/dadi / <i>U bolt c/w nuts</i>	∅ 16x70x160	4019628
36	722122	Staffa ant. Quadra c/dadi / <i>U bolt c/w nuts</i>	∅ 16x70x180	4694866
37	722123	Staffa ant. Quadra c/dadi / <i>U bolt c/w nuts</i>	∅ 16x70x200	-
38	722111	Staffa post. Quadra Piatta c/dadi / <i>U bolt c/w nuts</i>	∅ 18x80x360	110NC - 130NC
39	722112	Staffa post. Quadra Piatta c/dadi / <i>U bolt c/w nuts</i>	∅ 18x80x380	4645368
40	722113	Staffa post. Quadra Piatta c/dadi / <i>U bolt c/w nuts</i>	∅ 18x80x400	-

1 SOSPENSIONE ANTERIORE E POSTERIORE / FRONT AND REAR SUSPENSION



2 SOSPENSIONE ANTERIORE E POSTERIORE / FRONT AND REAR SUSPENSION



3 SOSPENSIONE ANTERIORE E POSTERIORE / FRONT AND REAR SUSPENSION

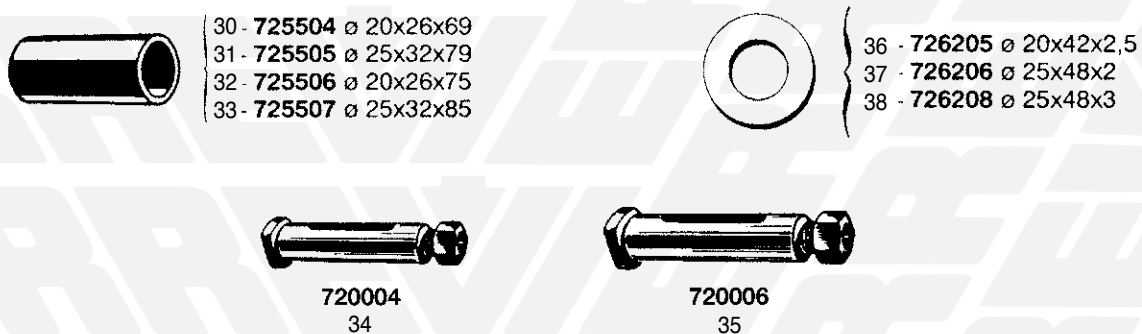
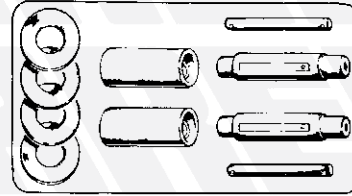
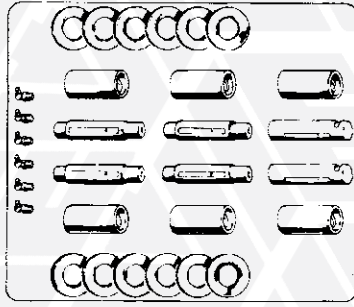


FIG. ITEM	RIF. ERREVI ERREVI REF.	DESCRIZIONE PARTICOLARI DESCRIPTION	TIPO VEHICLE MODEL	RIF. ORIG. ORIG. REF.
1 95.14 - 95.14 Z - 109.14 - 109.14 Z SOSPENSIONE ANTERIORE E POSTERIORE / FRONT AND REAR SUSPENSION				
1	711029	Complessivo revisione balestre ant. / Front spring repair kit		-
2	725551	Boccola balestra e biscottino ant. / Front spring eye and shackle bush	ø 24x30x69	542612
3	725523	Boccola balestra post. / Rear spring bush	ø 24x30x79	4517218
4	720046	Distanziale in acciaio perno balestra e biscottino / Front spring bush	ø 16x24x69	8564956
5	720043	Perno balestra e biscottino ant. / Front spring pin	ø 16x116	8565902
6	720010	Perno balestra post. lato ant. / Rear spring pin (front end)	ø 24x130	8581881 4517219
7	724633	Piastra biscottino ant. / Front shackle plate		8571569
8	726232	Rondella rasamento balestra e biscottino ant. / Thrust washer, front spring	ø 16x44x2,5	8564955
9	726229	Rondella rasamento balestra post. / Thrust washer, rear spring	ø 24x45x3	4517220
10	730114	Silentblock supporto barra stabilizzatrice post. / Silentblock	ø 20x46x55	4606379
11	722126	Staffa ant. Quadra c/dadi / U bolt c/w nuts	ø 16x70x150	-
12	722112	Staffa post. Quadra Piatta c/dadi / U bolt c/w nuts	ø 18x80x380	95.14 - 109.14 1ª Serie 8584087
13	722113	Staffa post. Quadra Piatta c/dadi / U bolt c/w nuts	ø 18x80x400	95.14 Z 8564994
14	722691	Staffa post. Quadra Piatta c/dadi / U bolt c/w nuts	ø 18x80x450	109.14 - 109.14 Z -
2 100.13/F13 SOSPENSIONE ANTERIORE E POSTERIORE / FRONT AND REAR SUSPENSION				
15	711040	Complessivo revisione balestre ant. / Front spring repair kit		-
16	711012	Complessivo revisione balestre post. / Rear spring repair kit		-
17	724611	Biscottino balestra post. / Rear shackle		8584386 4517216
18	725551	Boccola balestra e biscottino ant. / Front spring eye and shackle bush	ø 24x30x69	542612
19	725523	Boccola balestra e biscottino post. / Rear spring eye and shackle bush	ø 24x30x79	4517218
20	721541	Bullone centrale ant. c/dado / Centre bolt c/w nut	ø 14x150 T/H 24,5x31,7	-
21	721542	Bullone centrale ant. c/dado / Centre bolt c/w nut	ø 14x160 T/H 24,5x31,7	-
22	720046	Distanziale perno balestra e biscottino ant. / Front spring bush	ø 16x24x69	8564956
23	720043	Perno balestra e biscottino ant. / Front spring pin	ø 16x116	8565902
24	720010	Perno balestra e biscottino post. / Rear spring pin	ø 24x130	8581881 4517219
25	726884	Piastra biscottino ant. / Shackle plate, front spring		8563921
26	726232	Rondella rasamento anteriore / Thrust washer, front spring	ø 16x44x2,5	8564955
27	726229	Rondella rasamento posteriore / Thrust washer, rear spring	ø 24x45x3	4517220
28	722123	Staffa ant. Quadra c/dadi / U bolt c/w nuts	ø 16x70x200	-
29	722113	Staffa post. Quadra Piatta c/dadi / U bolt c/w nuts	ø 18x80x400	1ª Serie 8564994
3 642 N2/ N65 SOSPENSIONE ANTERIORE E POSTERIORE / FRONT AND REAR SUSPENSION				
30	725504	Boccola ant. in bronzo / Front spring bush	ø 20x26x69	379708
31	725505	Boccola post. in bronzo / Rear spring bush	ø 25x32x79	718950
32	725506	Boccola biscottino ant. in bronzo / Front shackle bush	ø 20x26x75	379714
33	725507	Boccola biscottino post. in bronzo / Front shackle bush	ø 25x32x85	718954
34	720004	Perno balestra e biscottino ant. c/dado / Front spring pin c/w nut	ø 20x110	747357
35	720006	Perno biscottino post. c/dado / Rear shackle pin c/w nut	ø 25x123	741831
36	726205	Rosetta rettificata balestra ant. / Thrust washer, front spring	ø 20x42x2,5	379707
37	726206	Rosetta rettificata balestra post. / Thrust washer, rear spring	ø 25x48x2	-
38	726208	Rosetta rettificata balestra post. / Thrust washer, rear spring	ø 25x48x3	379710

1 SOSPENSIONE ANTERIORE E POSTERIORE / FRONT AND REAR SUSPENSION



711044
2

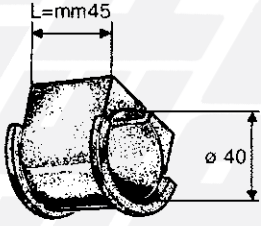
711025
1

10 - 730010
11 - 730114

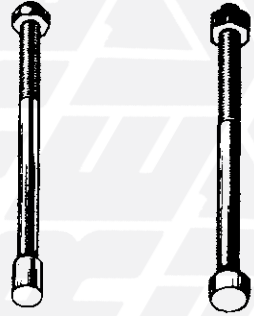
12 - 730108
ø 28x60x50

17 - 726233
18 - 726218
19 - 726234

3 - 725525
4 - 725510



730259
5



7 - 721699 ø 12x95 9 - 721187 ø 14x170
8 - 721185 ø 12x120

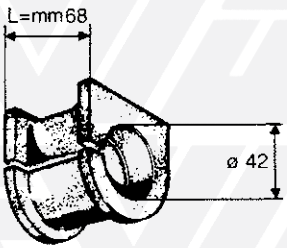


732722
28

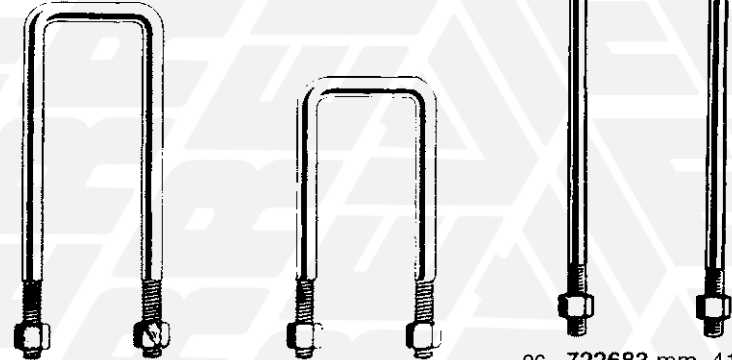
13 - 720049 ø 24/ ø 34 lt. 125
15 - 720051 ø 24/ ø 28 lt. 140



720050
14



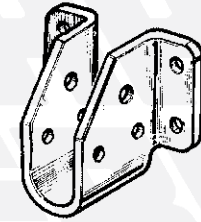
730263
6



20 - 722127 mm. 225 23 - 722126 mm. 150 26 - 722683 mm. 410
21 - 722020 mm. 250 24 - 722121 mm. 160 27 - 722691 mm. 450
22 - 722021 mm. 270 25 - 722122 mm. 180



721069
16



725078
29

2 SOSPENSIONE ANTERIORE / FRONT SUSPENSION



30 - 721145 ø 14x120



730010
31



32 - 726210
33 - 726233



34 - 722021 mm. 270
35 - 722574 mm. 280
36 - 722022 mm. 300



37 - 722121 mm. 160
38 - 722122 mm. 180
39 - 722123 mm. 200
40 - 722020 mm. 250

FIG. ITEM	RIF. ERREVI ERREVI REF.	DESCRIZIONE PARTICOLARI DESCRIPTION	TIPO VEHICLE MODEL	RIF. ORIG. ORIG. REF.
<div style="text-align: center;"> 1 115.14 - 115.17 - 135.14 - 135.17 - 145.17 SOSPENSIONE ANTERIORE E POSTERIORE / FRONT AND REAR SUSPENSION </div>				
1	711025	Complessivo revisione balestre ant. / Front spring repair kit		-
2	711044	Complessivo revisione balestre post. / Rear spring repair kit		-
3	725525	Boccola balestra e biscottino ant. <i>Front spring eye and shackle bush</i>	ø 34x42x68,8	61592893
4	725510	Boccola post. / <i>Rear spring bush</i>	ø 28x35x79	4501226
5	730259	Boccola elastica per staffa fiss. barra stabilizzatrice ant. <i>Rubber bush</i>		115.17 - 135.14/.17 - 145.17 4792127
6	730263	Boccola elastica per staffa fiss. barra stabilizzatrice post. <i>Rubber bush</i>		115.14/.17 - 135.17 4796746
7	721699	Bullone centrale ant. / <i>Centre bolt c/w nut</i>	ø 12x95 T/H 24,5x30	4789274
8	721185	Bullone centrale ant. / <i>Centre bolt c/w nut</i>	ø 12x120 T/H 24,5x30	-
9	721187	Bullone centrale post. / <i>Centre bolt c/w nut</i>	ø 14x170 T/H 24,5x20	-
10	730010	Estemblock barra stabilizzatrice ant. / <i>Silentblock</i>	ø 20x46x42	115.14 - 115.17 - 135.14 - 135.17 4606624
11	730114	Estemblock supporto sostegno barra stabilizz. post. / <i>Silentblock</i>	ø 20x46x55	115.17 4791448 4606379
12	730108	Estemblock supporto sostegno barra stabilizz. post / <i>Silentblock</i>	ø 28x60x50	135.14 - 135.17 - 145.17 4601722
13	720049	Perno ant. (lato ant.) e biscottino / <i>Front spring pin (front end)</i>	ø 24/34x125	61592895
14	720050	Perno ant. (lato post.) / <i>Front spring pin (rear end)</i>	ø 34x122	61592896
15	720051	Perno post. (lato ant.) / <i>Rear spring pin (front end)</i>	ø 24/28x140	4682651
16	721069	Perno post. (lato post.) / <i>Rear spring pin (rear end)</i>	ø 14x116	4782438
17	726233	Rondella balestra ant. e biscottino / <i>Front spring thrust washer</i>	ø 24x67x2	61596739
18	726218	Rondella balestra ant. (lato post.) <i>Front spring thrust washer (rear end)</i>	ø 36x66x3	61592894
19	726234	Rondella balestra post. / <i>Rear spring thrust washer</i>	ø 24x56x3	4682652
20	722127	Staffa ant. Quadra c/dadi lato ant. / <i>U bolt c/w nuts</i>	ø 16x70x225	4773231
21	722020	Staffa ant. Quadra c/dadi lato ant. / <i>U bolt c/w nuts</i>	ø 16x70x250	-
22	722021	Staffa ant. Quadra c/dadi lato ant. / <i>U bolt c/w nuts</i>	ø 16x70x270	-
23	722126	Staffa ant. Quadra c/dadi lato post. / <i>U bolt c/w nuts</i>	ø 16x70x150	4773232
24	722121	Staffa ant. Quadra c/dadi lato post. / <i>U bolt c/w nuts</i>	ø 16x70x160	-
25	722122	Staffa ant. Quadra c/dadi lato post. / <i>U bolt c/w nuts</i>	ø 16x70x180	-
26	722683	Staffa post. Quadra Piatta c/dadi / <i>U bolt c/w nuts</i>	ø 18x80x410	U.T. 4799184
27	722691	Staffa post. Quadra Piatta c/dadi / <i>U bolt c/w nuts</i>	ø 18x80x450	U.T. -
28	732722	Spessore in nylon per foglie balestre / <i>Nylon distance piece</i>		135.17 T - 145.17 4792626
29	725078	Supporto al telaio appoggio balestrino / <i>Helper spring bracket</i>		115.17 - 135.14 - 135.17 - 145.17 61591710
<div style="text-align: center;"> 2 150NC17/ NC20/ NT20 - 150.14/ .17 159NT20 - 165.24 T SOSPENSIONE ANTERIORE / FRONT SUSPENSION </div>				
30	721145	Bullone centrale / <i>Centre bolt c/w nut</i>	ø 14x120 T/H 24,5x24	4639421
31	730010	Estemblock braccio barra stabilizzatrice / <i>Silentblock</i>	ø 20x46x42	4606624
32	726210	Rondella balestra (lato post.) / <i>Spring thrust washer, rear end</i>	ø 28x60x3	4501232
33	726233	Rondella balestra (lato ant.) / <i>Spring thrust washer, front end</i>	ø 24x67x2	61596739
34	722021	Staffa lato post. Quadra c/dadi / <i>U bolt c/w nuts</i>	ø 16x70x270	61593550 61591102
35	722574	Staffa lato post. Quadra c/dadi / <i>U bolt c/w nuts</i>	ø 16x70x280	-
36	722022	Staffa lato post. Quadra c/dadi / <i>U bolt c/w nuts</i>	ø 16x70x300	-
37	722121	Staffa lato ant. Quadra c/dadi / <i>U bolt c/w nuts</i>	ø 16x70x160	150NT20 61593553
38	722122	Staffa lato ant. Quadra c/dadi / <i>U bolt c/w nuts</i>	ø 16x70x180	150.14/ .17 - 150NC17/ NC20 4683303
39	722123	Staffa lato ant. Quadra c/dadi / <i>U bolt c/w nuts</i>	ø 16x70x200	159NT20 - 165.24T 61598106
40	722020	Staffa lato ant. Quadra c/dadi / <i>U bolt c/w nuts</i>	ø 16x70x250	159NT20 - 165.24T 61593554

1 SOSPENSIONE ANTERIORE / FRONT SUSPENSION

711025
1

725525
2

720049
5

730010
4

720050
6

7 - 726233
8 - 726218

L=mm45
ø 40
730259
3

9 - 722021 ø 16x70x270
10 - 722574 ø 16x70x280
11 - 722022 ø 16x70x300

12 - 722123 ø 16x70x200

2 SOSPENSIONE POSTERIORE / REAR SUSPENSION

L = mm. 580
712648
13

730191
14

725510
16

730095
17

92
ø 52

720051
19

720013
18

22 - 722038 ø 24x80x480

725075
23

20 - 726210
21 - 726234

725078
24

L = mm. 356
712536
25

711026
15

FIG. ITEM	RIF. ERREVI ERREVI REF.	DESCRIZIONE PARTICOLARI DESCRIPTION	TIPO VEHICLE MODEL	RIF. ORIG. ORIG. REF.
<div style="display: flex; align-items: center;"> <div style="border: 1px solid black; border-radius: 50%; width: 30px; height: 30px; display: flex; align-items: center; justify-content: center; margin-right: 10px;">1</div> <div> <p>159NC20/ F20/ .20 159F20T/ .20T - 165.24 175.17 - 175.24</p> <p>SOSPENSIONE ANTERIORE / FRONT SUSPENSION</p> </div> </div>				
1	711025	Complessivo revisione balestre / Front spring repair kit		-
2	725525	Boccola balestra e biscottino / <i>Spring eye and shackle bush</i>	ø 34x42x68,8	61592893
3	730259	Boccola elastica per staffa fiss. barra stabilizzatrice ant. / <i>Rubber bush</i>		175.17/.24
4	730010	Estemblock per tirante barra stabilizzatrice / <i>Silentblock</i>	ø 20x46x42	4606624
5	720049	Perno balestra (lato ant.) e biscottino / <i>Spring pin (front end)</i>	ø 24/34x125	61592895
6	720050	Perno lato post. / <i>Spring pin (rear end)</i>	ø 34x122	61592896
7	726233	Rondella balestra (lato ant.) e biscottino / <i>Spring thrust washer (front end)</i>	ø 24x67x2	61596739
8	726218	Rondella balestra (lato post.) / <i>Spring thrust washer (rear end)</i>	ø 36x66x3	61592894
9	722021	Staffa (lato ant.) Quadra c/dadi / <i>U bolt c/w nuts</i>	ø 16x70x270	4859826 4770916
10	722574	Staffa (lato ant.) Quadra c/dadi / <i>U bolt c/w nuts</i>	ø 16x70x280	-
11	722022	Staffa (lato ant.) Quadra c/dadi / <i>U bolt c/w nuts</i>	ø 16x70x300	-
12	722123	Staffa (lato post.) Quadra c/dadi / <i>U bolt c/w nuts</i>	ø 16x70x200	-
<div style="display: flex; align-items: center;"> <div style="border: 1px solid black; border-radius: 50%; width: 30px; height: 30px; display: flex; align-items: center; justify-content: center; margin-right: 10px;">2</div> <div> <p>150/159NC20/ F20/ .20 150/159NT20/ F20T/ .20T - 150.14/ .17 165.24 - 175.17 - 175.24</p> <p>SOSPENSIONE POSTERIORE / REAR SUSPENSION</p> </div> </div>				
13	712648	Barra di reazione compl. / <i>Torque arm (Sosp. Pneumatica / Air Suspension)</i>		175.24P 4714134 98488010
14	730191	Kit revisione barra CON PERNO / <i>Torque arm repair kit c/w pin (Sosp. Pneumatica / Air Suspension)</i>		175.24P 2980884
15	711026	Complessivo revisione balestre / Rear spring repair kit		-
16	725510	Boccola balestra e biscottino / <i>Spring bush</i>	ø 28x35x79	4501226
17	730095	Fascia fissaggio barra stabilizzatrice / <i>Rubber pad (Sosp. Pneumatica / Air Suspension)</i>		175.24P 4735723
18	720013	Perno balestra (lato post.) / <i>Spring pin (rear end)</i>	ø 28x140	4501231
19	720051	Perno balestra (lato ant.) e biscottino / <i>Spring pin (front end)</i>	ø 24/28x140	4682651
20	726210	Rondella balestra (lato post.) / <i>Spring thrust washer, (rear end)</i>	ø 28x60x3	4501232
21	726234	Rondella balestra (lato ant.) e biscottino / <i>Spring thrust washer, (front end)</i>	ø 24x56x3	4682652
22	722038	Staffa Quadra Piatta c/dadi / <i>U bolt c/w nuts</i>	ø 24x80x480	-
23	725075	Supporto al telaio appoggio balestrino / <i>Helper spring bracket</i>		61597731
24	725078	Supporto al telaio appoggio balestrino / <i>Helper spring bracket</i>		165.24T 61591710
25	712536	Tirante completo barra stabilizzatrice / <i>Stabilizer bar rod (Sosp. Pneumatica / Air Suspension)</i>		175.24P 4741171

SOSPENSIONE SUSPENSION

1 SOSPENSIONE ANTERIORE / FRONT SUSPENSION

1 - 725512 \varnothing 30x38x90
 2 - 725513 \varnothing 30x35x95



3 - 721151 \varnothing 14x110 T 14
 4 - 721154 \varnothing 14x150 T 14



5 - 721164 \varnothing 14x150



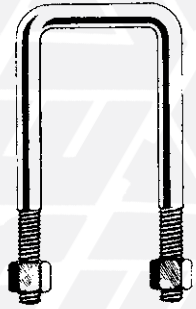
729302
6



720020
7



8 - 726211 spess. mm. 1,5
 9 - 726212 spess. mm. 2,0
 10 - 726213 spess. mm. 3,0
 11 - 726214 spess. mm. 4,0
 12 - 726215 spess. mm. 5,0



13 - 722060 \varnothing 20x90x145
 14 - 722061 \varnothing 20x90x160
 15 - 722063 \varnothing 20x90x180
 16 - 722064 \varnothing 20x90x200
 17 - 722065 \varnothing 20x90x220
 18 - 722067 \varnothing 20x90x230
 19 - 722066 \varnothing 20x90x240

2 SOSPENSIONE POSTERIORE / REAR SUSPENSION

20 - 725514 \varnothing 35x45x100
 21 - 725515 \varnothing 35x40x105



22 - 721173 \varnothing 14x255



729310
23



730052
24



720025
25



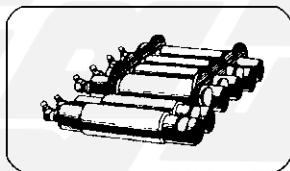
26 - 726221 mm. 1
 27 - 726216 mm. 1,5
 28 - 726217 mm. 2
 29 - 726218 mm. 3
 30 - 726219 mm. 4
 31 - 726220 mm. 5



724703
32

FIG. ITEM	RIF. ERREVI ERREVI REF.	DESCRIZIONE PARTICOLARI DESCRIPTION		TIPO VEHICLE MODEL	RIF. ORIG. ORIG. REF.
<div style="display: flex; align-items: center;"> <div style="border: 1px solid black; border-radius: 50%; width: 40px; height: 40px; display: flex; align-items: center; justify-content: center; margin-right: 10px;">1</div> <div> <p>682 N3/ N4 - 180NC</p> <p>SOSPENSIONE ANTERIORE / FRONT SUSPENSION</p> </div> </div>					
1	725512	Boccola balestra / Spring bush	∅ 30x38x90		4548076
2	725513	Boccola biscottino / Shackle bush	∅ 30x35x95		4031947
3	721151	Bullone centrale c/dado / Centre bolt c/w nut	∅ 14x110	180NC	4535318
4	721154	Bullone centrale c/dado / Centre bolt c/w nut	∅ 14x150		-
5	721164	Bullone centrale c/dado / Centre bolt c/w nut	∅ 14x150		-
6	729302	Dado staffa balestra / U bolt nut			16108023 26089431
7	720020	Perno balestra e biscottino c/dado / Spring pin	∅ 30x135		844933
8	726211	Rondella balestra / Spring thrust washer	∅ 30x56x1,5		-
9	726212	Rondella balestra / Spring thrust washer	∅ 30x56x2		-
10	726213	Rondella balestra / Spring thrust washer	∅ 30x56x3		856616
11	726214	Rondella balestra / Spring thrust washer	∅ 30x56x4		-
12	726215	Rondella balestra / Spring thrust washer	∅ 30x56x5		-
13	722060	Staffa Quadra c/dadi / U bolt c/w nuts	∅ 20x90x145		844934
14	722061	Staffa Quadra c/dadi / U bolt c/w nuts	∅ 20x90x160		-
15	722063	Staffa Quadra c/dadi / U bolt c/w nuts	∅ 20x90x180		4010786
16	722064	Staffa Quadra c/dadi / U bolt c/w nuts	∅ 20x90x200		-
17	722065	Staffa Quadra c/dadi / U bolt c/w nuts	∅ 20x90x220	682N3/N4	-
18	722067	Staffa Quadra c/dadi / U bolt c/w nuts	∅ 20x90x230	682N3/N4	-
19	722066	Staffa Quadra c/dadi / U bolt c/w nuts	∅ 20x90x240	682N3/N4	-
<div style="display: flex; align-items: center;"> <div style="border: 1px solid black; border-radius: 50%; width: 40px; height: 40px; display: flex; align-items: center; justify-content: center; margin-right: 10px;">2</div> <div> <p>682 N3/ N4 - 180NC</p> <p>SOSPENSIONE POSTERIORE / REAR SUSPENSION</p> </div> </div>					
20	725514	Boccola balestra / Spring bush	∅ 35x45x100		701835
21	725515	Boccola biscottino / Shackle bush	∅ 35x40x105		4031950
22	721173	Bullone centrale c/dado / Centre bolt c/w nut	∅ 14x255		-
23	729310	Dado staffa balestra / U bolt nut	M26x2		16108123 27020321
24	730052	Paracolpo balestra 2 fori / Rubber buffer			844792
25	720025	Perno balestra e biscottino / Spring pin	∅ 35x153		844784
26	726221	Rondella balestra / Spring thrust washer	∅ 36x66x1		-
27	726216	Rondella balestra / Spring thrust washer	∅ 36x66x1,5		-
28	726217	Rondella balestra / Spring thrust washer	∅ 36x66x2		-
29	726218	Rondella balestra / Spring thrust washer	∅ 36x66x3		856612
30	726219	Rondella balestra / Spring thrust washer	∅ 36x66x4		-
31	726220	Rondella balestra / Spring thrust washer	∅ 36x66x5		-
32	724703	Tassello appoggio balestrino in ghisa / Helper spring pad (cast-iron)			848073

1 SOSPENSIONE ANTERIORE E POSTERIORE FRONT AND REAR SUSPENSION



711023
1



725524
2



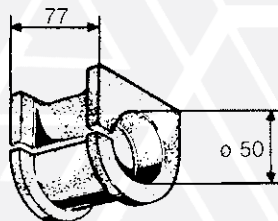
729304
5



3 - 721108 \varnothing 14x260 T./Head 9
4 - 721109 \varnothing 14x300 T./Head 9



730108 \varnothing 28x60x50
6



730064
7



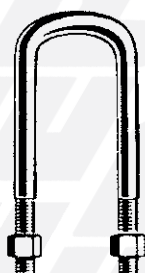
8 - 720057



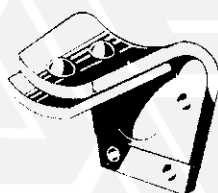
9 - 720058



10 - 726231
11 - 726218



12 - 722101 \varnothing 20x90x210

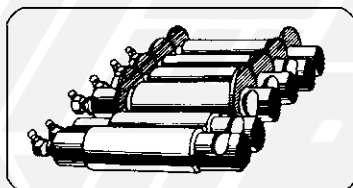


725070
13

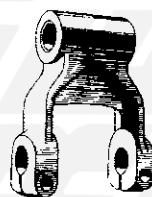


730039
14

2 SOSPENSIONE ANTERIORE / FRONT SUSPENSION



711019
15



724617
16



17 - 725518 \varnothing 30x38x90
18 - 725513 \varnothing 30x35x95



20 - 720030 693N1
19 - 720032 619 - 697 - 300



726230
21



22 - 726212 mm. 2
23 - 726213 mm. 3

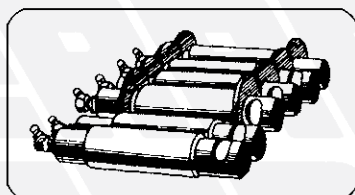


24 - 722063 mm. 180
25 - 722064 mm. 200
26 - 722065 mm. 220



730039
27

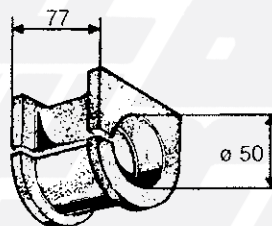
3 SOSPENSIONE POSTERIORE / REAR SUSPENSION



711009
28



29 - 725514 \varnothing 35x45x100
30 - 725515 \varnothing 35x40x105



730064
31



34 726217 \varnothing 36x66x2
35 726218 \varnothing 36x66x3



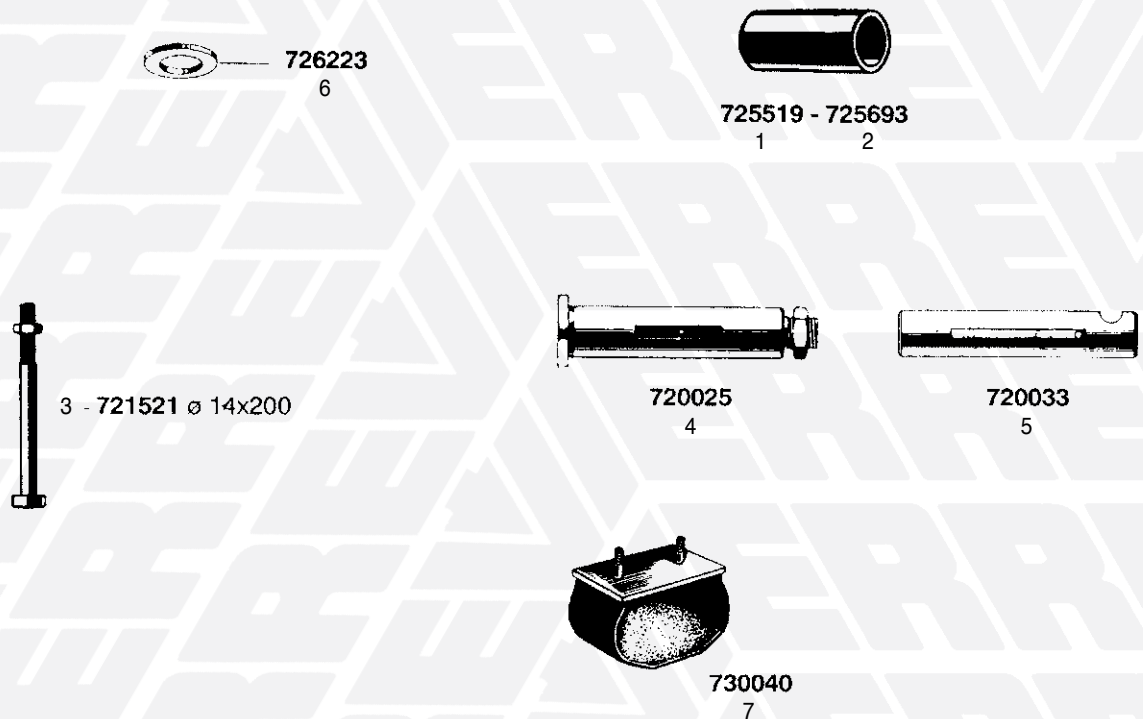
720031
33

32 721173 \varnothing 14x255 T./Head 30x11



FIG. ITEM	RIF. ERREVI ERREVI REF.	DESCRIZIONE PARTICOLARI DESCRIPTION	TIPO VEHICLE MODEL	RIF. ORIG. ORIG. REF.
1 684 NP/TP - 160 NC/ NT				
SOSPENSIONE ANTERIORE E POSTERIORE / FRONT AND REAR SUSPENSION				
1	711023	Completivo revisione balestre ant. e post. / <i>Spring repair kit</i>		-
2	725524	Boccola balestra e biscottino ant. e post. / <i>Spring bush</i>	ø 35x45x90	42071717 4652071
3	721108	Bullone centrale post. c/dado / <i>Centre bolt c/w nut</i>	ø 14x260 T/Head h.9	-
4	721109	Bullone centrale post. c/dado / <i>Centre bolt c/w nut</i>	ø 14x300 T/Head h.9	-
5	729304	Dado staffa balestra post. / <i>U bolt nut, rear spring</i>	M24x2	-
6	730108	Estemblock barra stabilizzatrice post. / <i>Silentblock</i>	ø 28x60x50	4601722
7	730064	Fascia in gomma per barra stabilizzatrice post. / <i>Rubber pad</i>		4688153
8	720057	Perno balestra ant. e post. / <i>Spring pin</i>	ø 30/35x152	4652073
9	720058	Perno biscottino ant. e post. / <i>Shackle pin</i>	ø 35x152	4652077
10	726231	Rondella balestra ant. e post. / <i>Spring thrust washer</i>	ø 30x63x3	4652074
11	726218	Rondella biscottino ant. e post. / <i>Shackle thrust washer</i>	ø 36x66x3	856612
12	722101	Staffa ant. Semitonda c/dadi / <i>U bolt c/w nuts</i>	ø 20x90x210	-
13	725070	Supporto al telaio appoggio balestrino U.T. / <i>Helper spring bracket</i>		4708435
14	730039	Tampone paracolpo balestra ant. / <i>Rubber buffer (front spring)</i>		4651992
2 619N1/ N1P - 300PC				
SOSPENSIONE ANTERIORE / FRONT SUSPENSION				
15	711019	Completivo revisione balestre / <i>Front spring repair kit</i>	619 - 697 - 300	-
16	724617	Biscottino balestra / <i>Shackle</i>	619 - 697 - 300	4624920
17	725518	Boccola balestra in bronzo / <i>Spring bush</i>	ø 30x38x90	4510824
18	725513	Boccola biscottino in bronzo / <i>Shackle bush</i>	ø 30x35x95	4031947
19	720032	Perno balestra e biscottino / <i>Spring pin</i>	ø 30x150	619 - 697 - 300 4637576
20	720030	Perno balestra e biscottino / <i>Spring pin</i>	ø 30x153	4508340
21	726230	Rondella rasamento / <i>Thrust washer</i>	ø 30x56x3	619 - 697 - 300 4639010
22	726212	Rondella rasamento rettificata / <i>Spring thrust washer</i>	ø 30x56x2	-
23	726213	Rondella rasamento rettificata / <i>Spring thrust washer</i>	ø 30x56x3	856616
24	722063	Staffa Quadra c/dadi / <i>U bolt c/w nuts</i>	ø 20x90x180	4667226
25	722064	Staffa Quadra c/dadi / <i>U bolt c/w nuts</i>	ø 20x90x200	-
26	722065	Staffa Quadra c/dadi / <i>U bolt c/w nuts</i>	ø 20x90x220	-
27	730039	Tassello in gomma paracolpo balestra / <i>Rubber buffer</i>	697 - 300PC	4651992
3 619 N1 - 619 N1P				
SOSPENSIONE POSTERIORE / REAR SUSPENSION				
28	711009	Completivo revisione balestre / <i>Rear spring repair kit</i>		-
29	725514	Boccola balestra in bronzo / <i>Spring bush</i>	ø 35x45x100	701835
30	725515	Boccola biscottino in bronzo / <i>Shackle bush</i>	ø 35x40x105	4031950
31	730064	Boccola in gomma tirante barra stabilizzatrice / <i>Rubber pad</i>		4688153
32	721173	Bullone centrale c/dado / <i>Centre bolt c/w nut</i>	ø 14x255 T./Head 30x11	4574181
33	720031	Perno balestra / <i>Spring pin</i>	ø 35x165	4511226
34	726217	Rondella rasamento / <i>Spring thrust washer</i>	ø 36x66x2	-
35	726218	Rondella rasamento / <i>Spring thrust washer</i>	ø 36x66x3	856612

1 SOSPENSIONE POSTERIORE / REAR SUSPENSION



2 BILANCIERE / EQUALIZER ASSY

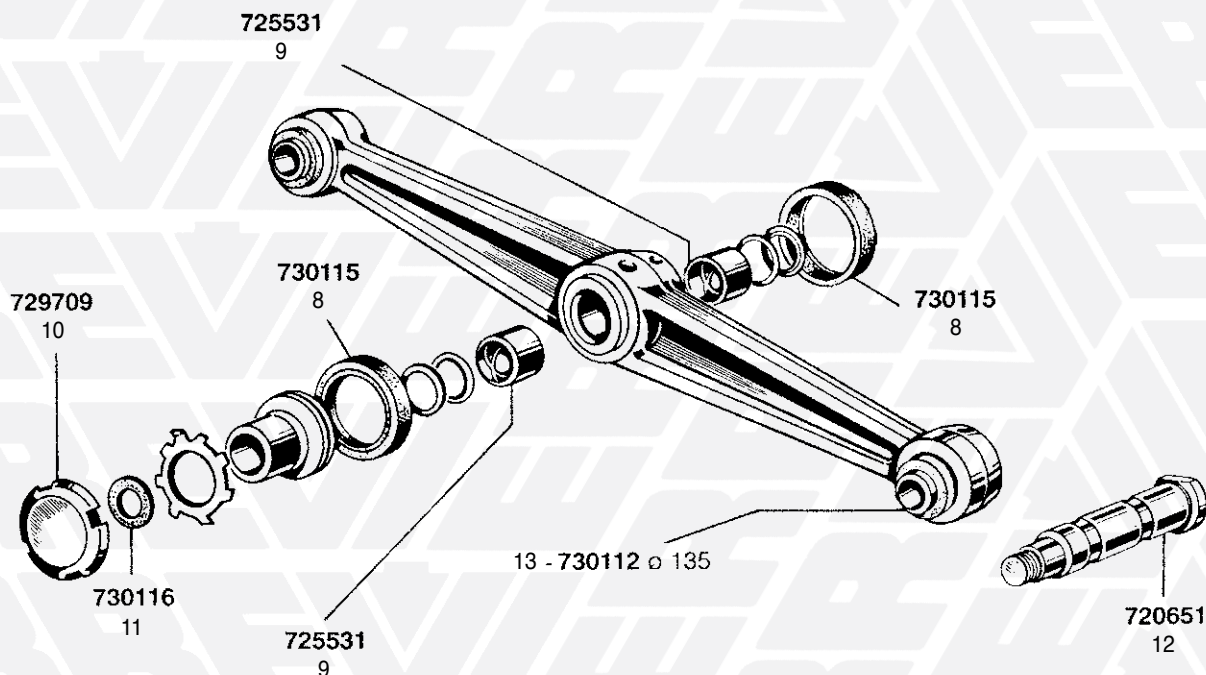
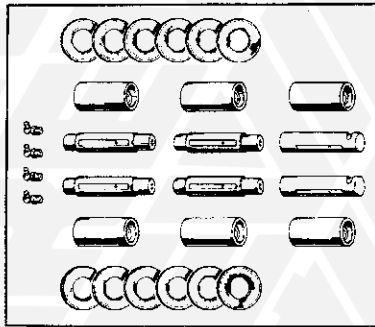


FIG. ITEM	RIF. ERREVI ERREVI REF.	DESCRIZIONE PARTICOLARI DESCRIPTION	TIPO VEHICLE MODEL	RIF. ORIG. ORIG. REF.
<div style="text-align: center;"> 1 697 NP - 300 PC SOSPENSIONE POSTERIORE / REAR SUSPENSION </div>				
1	725519	Boccola balestra / <i>Spring bush</i>	∅ 35x45x100	4600521
2	725693	Boccola balestra parabolica / <i>Spring bush (parabolic suspension)</i>	∅ 35x42x100	300 PC U.T. -
3	721521	Bullone centrale c/dado / <i>Centre bolt c/w nut</i>	∅ 14x200 T/H 22x11	697NP - 300PC -
4	720025	Perno balestra c/dado / <i>Spring pin</i>	∅ 35x153	693N1 - 697N 4578074
5	720033	Perno balestra / <i>Spring pin</i>	∅ 35x183	697NP - 300PC 4665034 4600699
6	726223	Rondella bullone fissaggio piastra balestra / <i>Washer</i>	∅ 26,5x45x5	4605974
7	730040	Tampone paracolpi controfolgia balestra / <i>Rubber buffer</i>		300PC 4688579
<div style="text-align: center;"> 2 697 NP - 300 PC BILANCIERE / EQUALIZER ASSY </div>				
8	730115	Anello paragrasso in gomma perno centrale / <i>Seal</i>	∅ 137,5x157x29	4621786
9	725531	Boccola centrale bilanciata / <i>Rocker beam bush</i>	∅ 88,5x96,8x75	4599482
10	729709	Ghiera perno centrale 2ª Serie / <i>Locknut</i>		4651009
11	730116	Guarnizione ghiera perno centrale 2ª Serie / <i>Seal</i>		4651010
12	720651	Perno laterale bilanciata / <i>Rocker-beam pin</i>	∅ 63,5/50x223	4660447
13	730112	Estemblock laterale bilanciata / <i>Beam-end bushing</i>	∅ 64x135x146	697NP - 300PC 4611103

SOSPENSIONE ANTERIORE / FRONT SUSPENSION



711065
1



725524
2



3 - 721628 \varnothing 14x120 T/Head 28
4 - 721629 \varnothing 14x140 T/Head 28



729302
5



720058
9



10 - 726243 mm. 2
11 - 726244 mm. 2,5
12 - 726231 mm. 3
13 - 726245 mm. 3,5



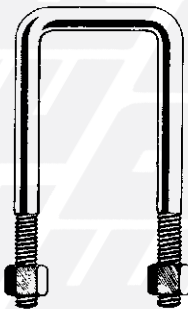
14 - 726217 mm. 2
15 - 726218 mm. 3



730114
6



7 - 720057
8 - 720055



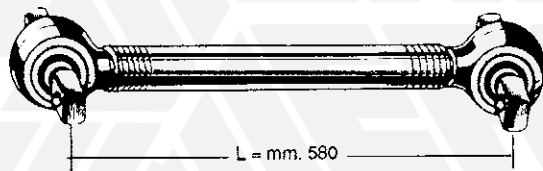
16 - 722061 \varnothing 20x90x160
17 - 722063 \varnothing 20x90x180
18 - 722064 \varnothing 20x90x200
19 - 722065 \varnothing 20x90x220
20 - 722067 \varnothing 20x90x230
21 - 722066 \varnothing 20x90x240
22 - 722068 \varnothing 20x90x260



732723
23

FIG. ITEM	RIF. ERREVI ERREVI REF.	DESCRIZIONE PARTICOLARI DESCRIPTION	TIPO VEHICLE MODEL	RIF. ORIG. ORIG. REF.
<p>160.26 U.T. - 170/190NC26/ F26/ F35 170/190NC33 - 170NC35 180.24/ .26 - 190i26/ i35 - 190.30/ .38 220F35T/ .36PT/ .38P - 240.30/ .38P</p> <p>SOSPENSIONE ANTERIORE / FRONT SUSPENSION</p>				
1	711065	Complessivo revisione balestre / Front spring repair kit		-
2	725524	Boccola balestra e biscottino <i>Spring eye and shackle bush</i>	ø 35x45x90	42071717 4652071
3	721628	Bullone centrale c/dado u.t. / <i>Centre bolt c/w nut</i>	ø 14x120 T/ Head h.28	42072598
4	721629	Bullone centrale c/dado u.t. / <i>Centre bolt c/w nut</i>	ø 14x140 T/ Head h.28	-
5	729302	Dado staffa / <i>U bolt nut</i>	M20x1,5	12164323
6	730114	Estemblock supporto barra / <i>Stabilizer bar bushing</i>	ø 20x46x55	4606379
7	720057	Perno balestra (lato post.) / <i>Spring pin, rear end</i>	ø 30/35x152	4652073
8	720055	Perno balestra (lato ant.) / <i>Spring pin, front end</i>	ø 30/35x152	4703374
9	720058	Perno biscottino / <i>Shackle pin</i>	ø 35x152	4652077
10	726243	Rondella c/bisello rasamento / <i>Spring thrust washer</i>	ø 30x63x2	-
11	726244	Rondella c/bisello rasamento / <i>Spring thrust washer</i>	ø 30x63x2,5	-
12	726231	Rondella c/bisello rasamento / <i>Spring thrust washer</i>	ø 30x63x3	4652074
13	726245	Rondella c/bisello rasamento / <i>Spring thrust washer</i>	ø 30x63x3,5	-
14	726217	Rondella rasamento biscottino / <i>Shackle thrust washer</i>	ø 36x66x2	-
15	726218	Rondella rasamento biscottino / <i>Shackle thrust washer</i>	ø 36x66x3	856612
16	722061	Staffa Quadra c/dadi / <i>U bolt c/w nuts</i>	ø 20x90x160	4704296
17	722063	Staffa Quadra c/dadi / <i>U bolt c/w nuts</i>	ø 20x90x180	-
18	722064	Staffa Quadra c/dadi / <i>U bolt c/w nuts</i>	ø 20x90x200	4704297
19	722065	Staffa Quadra c/dadi / <i>U bolt c/w nuts</i>	ø 20x90x220	4698676 4733570
20	722067	Staffa Quadra c/dadi / <i>U bolt c/w nuts</i>	ø 20x90x230	4733568
21	722066	Staffa Quadra c/dadi / <i>U bolt c/w nuts</i>	ø 20x90x240	4733126 4712188
22	722068	Staffa Quadra c/dadi / <i>U bolt c/w nuts</i>	ø 20x90x260	-
23	732723	Spessore in nylon foglie balestra parabolica <i>Nylon distance piece (parabolic spring)</i>		42052764

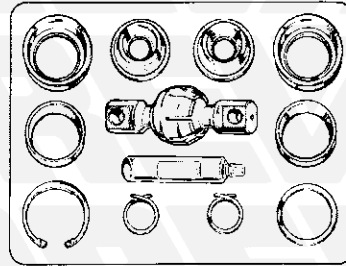
SOSPENSIONE POSTERIORE / REAR SUSPENSION



L = mm. 580

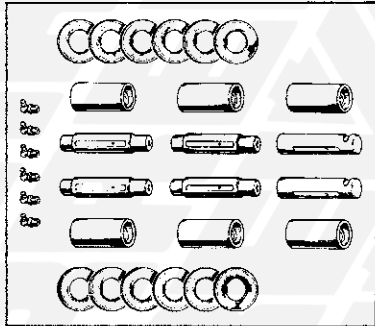
712648

1



730191

2



711065

3



725524

4



5 - 721108 \varnothing 14x260 T/Head 9
6 - 721109 \varnothing 14x300 T/Head 9



7 - 721220 \varnothing 14x250 T/Head 15
8 - 721242 \varnothing 14x280 T/Head 15



720057 - 720055

12

13



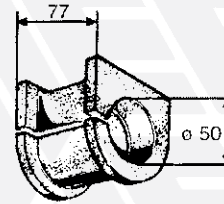
720058

14



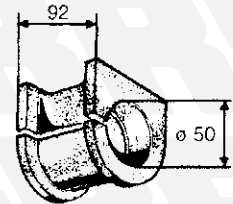
730108 \varnothing 28x60x50

9



730064

10



730095

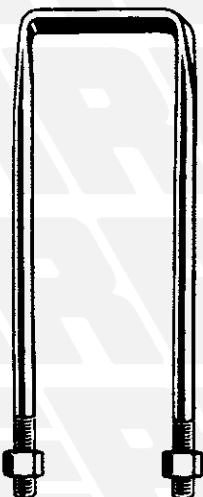
11



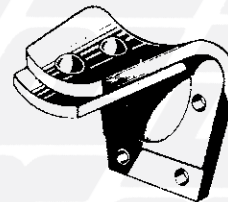
15 - 726243 mm. 2
16 - 726244 mm. 2,5
17 - 726231 mm. 3
18 - 726245 mm. 3,5



19 - 726217 mm. 2
20 - 726218 mm. 3

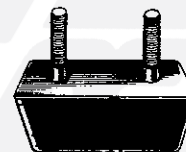


21 - 722508 \varnothing 26x90x450
22 - 722505 \varnothing 26x90x480
23 - 722516 \varnothing 26x90x520
24 - 722517 \varnothing 26x90x540



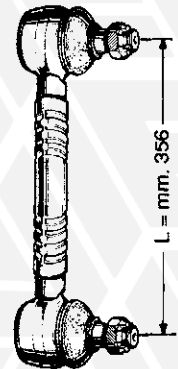
725070

25



730067

26



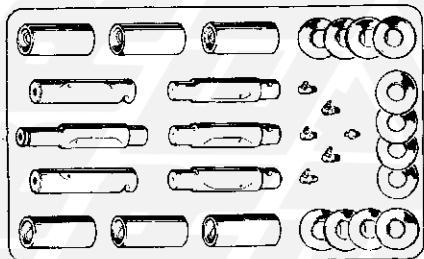
L = mm. 356

712536

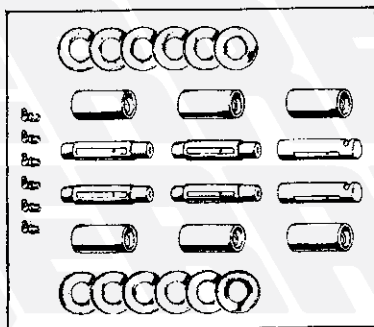
27

FIG. ITEM	RIF. ERREVI ERREVI REF.	DESCRIZIONE PARTICOLARI DESCRIPTION	TIPO VEHICLE MODEL	RIF. ORIG. ORIG. REF.
<p>160.26 U.T. - 170/190NC26/ F26/ F35 170/190NC33 - 170NC35 - 180.24/ .26 190i26/ i35 - 190.30/ .38</p> <p>SOSPENSIONE POSTERIORE / REAR SUSPENSION</p>				
1	712648	Barra di reazione completa / <i>Torque arm</i> (Sosp. Pneumatica / <i>Air Suspension</i>)	190.30P/ .38P	4714134 98488010
2	730191	Kit revisione barra con perno / <i>Torque arm repair kit c/w pin</i> (Sosp. Pneumatica / <i>Air Suspension</i>)	190.30P/ .38P	2980884
3	711065	Complessivo revisione balestre / Rear spring repair kit		-
4	725524	Boccola balestra e biscottino / <i>Spring eye and shackle bush</i>	ø 35x45x90	42071717 4652071
5	721108	Bullone centrale c/dado / <i>Centre bolt c/w nut</i>	ø 14x260 T/H 25x9	-
6	721109	Bullone centrale c/dado / <i>Centre bolt c/w nut</i>	ø 14x300 T/H 25x9	-
7	721220	Bullone centrale c/dado U.T. / <i>Centre bolt c/w nut</i>	ø 14x250 T/H 24,5x15	-
8	721242	Bullone centrale c/dado U.T. / <i>Centre bolt c/w nut</i>	ø 14x280 T/H 24,5x15	-
9	730108	Estemblock supporto sup. barra / <i>Rubber bushing</i>	ø 28x60x50	4601722
10	730064	Fascia fissaggio barra stabilizzatrice / <i>Rubber pad</i>		4688153
11	730095	Fascia fissaggio barra stabilizzatrice / <i>Rubber pad</i> (Sosp. Pneumatica / <i>Air Suspension</i>)	190.30PT/ .38PT	4735723
12	720057	Perno balestra (lato post.) / <i>Spring pin, rear end</i>	ø 30/35x152	4652073
13	720055	Perno balestra (lato ant.) / <i>Spring pin, front end</i>	ø 30/35x152	4703374
14	720058	Perno biscottino / <i>Shackle pin</i>	ø 35x152	4652077
15	726243	Rondella c/bisello rasamento / <i>Spring thrust washer</i>	ø 30x63x2	-
16	726244	Rondella c/bisello rasamento / <i>Spring thrust washer</i>	ø 30x63x2,5	-
17	726231	Rondella c/bisello rasamento / <i>Spring thrust washer</i>	ø 30x63x3	4652074
18	726245	Rondella c/bisello rasamento / <i>Spring thrust washer</i>	ø 30x63x3,5	-
19	726217	Rondella rasamento biscottino / <i>Shackle thrust washer</i>	ø 36x66x2	-
20	726218	Rondella rasamento biscottino / <i>Shackle thrust washer</i>	ø 36x66x3	856612
21	722508	Staffa Quadra Piatta c/dadi / <i>U bolt c/w nuts</i>	ø 26x90x450	-
22	722505	Staffa Quadra Piatta c/dadi / <i>U bolt c/w nuts</i>	ø 26x90x480	4723314
23	722516	Staffa Quadra Piatta c/dadi / <i>U bolt c/w nuts</i>	ø 26x90x520	-
24	722517	Staffa Quadra Piatta c/dadi / <i>U bolt c/w nuts</i>	ø 26x90x540	-
25	725070	Supporto al telaio appoggio balestrino U.T. / <i>Helper spring support</i>		4708435
26	730067	Tampone in gomma appoggio balestrino / <i>Rubber buffer</i>		4699682
27	712536	Tirante completo barra stabilizzatrice / <i>Stabilizer bar rod</i> (Sosp. Pneumatica / <i>Air Suspension</i>)	190.30PT/ .38PT	4741171

SOSPENSIONE ANTERIORE / FRONT SUSPENSION



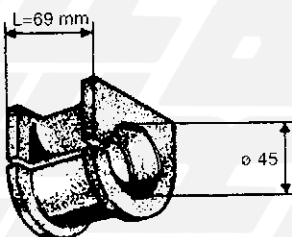
711063
1



711065
2



725524
3



730283
4



5 - 721628 ø 14x120 T/Head 28
6 - 721629 ø 14x140 T/Head 28



730108 ø 28x60x50
7



720069
8



9 - 720057
10 - 720055



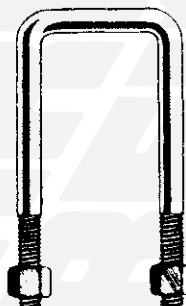
720058
11



12 - 726243 mm. 2
13 - 726244 mm. 2.5
14 - 726231 mm. 3
15 - 726245 mm. 3,5



16 - 726217 mm. 2
17 - 726218 mm. 3



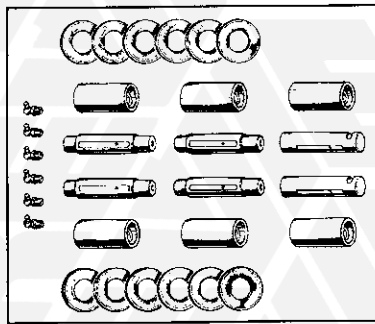
18 - 722067 ø 20x90x230
19 - 722066 ø 20x90x240
20 - 722068 ø 20x90x260



732723
21

FIG. ITEM	RIF. ERREVI ERREVI REF.	DESCRIZIONE PARTICOLARI DESCRIPTION	TIPO VEHICLE MODEL	RIF. ORIG. ORIG. REF.
<p>190.33 - 190.36 - 190.42 - 190.48 240.36 - 240.48 - 260.36 - 260.4</p> <p>TURBOSTAR</p> <p>190.24/ .26/ .30/ .32 - 240.26 - 260.32</p> <p>TURBOTECH</p> <p>SOSPENSIONE ANTERIORE / FRONT SUSPENSION</p>				
1	711063	Complessivo revisione balestre / <i>Front spring repair kit</i>	TURBOSTAR	-
2	711065	Complessivo revisione balestre / <i>Front spring repair kit</i>	TURBOTECH	-
3	725524	Boccola p/balestra e biscottino / <i>Spring eye and shackle bush</i>		42071717 4652071
4	730283	Boccola elastica per barra stabilizzatrice / <i>Rubber pad</i>		4731981
5	721628	Bullone centrale c/dado / <i>Centre bolt c/w nut</i>		42072598
6	721629	Bullone centrale c/dado / <i>Centre bolt c/w nut</i>		-
7	730108	Estemblock supporto sup. barra stabilizzatrice / <i>Rubber bushing</i>		4601722
8	720069	Perno lato anteriore / <i>Spring pin, front end</i>	TURBOSTAR	42073084
9	720057	Perno lato posteriore / <i>Spring pin, rear end</i>		4652073
10	720055	Perno lato anteriore / <i>Spring pin, front end</i>		4703374
11	720058	Perno per biscottino / <i>Shackle pin</i>		4652077
12	726243	Rondella c/bisello rasamento / <i>Spring thrust washer</i>		-
13	726244	Rondella c/bisello rasamento / <i>Spring thrust washer</i>		-
14	726231	Rondella c/bisello rasamento / <i>Spring thrust washer</i>		4652074
15	726245	Rondella c/bisello rasamento / <i>Spring thrust washer</i>		-
16	726217	Rondella rasamento biscottino / <i>Shackle thrust washer</i>		-
17	726218	Rondella rasamento biscottino / <i>Shackle thrust washer</i>		856612
18	722067	Staffa Quadra c/dadi / <i>U bolt c/w nuts</i>		4733568
19	722066	Staffa Quadra c/dadi / <i>U bolt c/w nuts</i>		-
20	722068	Staffa Quadra c/dadi / <i>U bolt c/w nuts</i>		-
21	732723	Spessore in nylon per foglie balestra parabolica <i>Nylon distance piece (parabolic spring)</i>		42052764

SOSPENSIONE POSTERIORE / REAR SUSPENSION



711065
1



725524
2



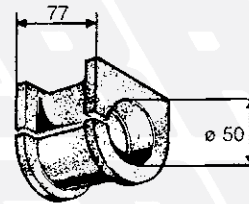
730295
3



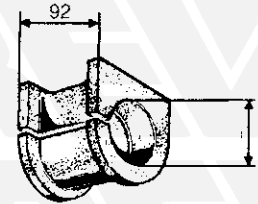
4 - 721108 \varnothing 14x260 T/Head 9
5 - 721109 \varnothing 14x300 T/Head 9



6 - 721220 \varnothing 14x250 T/Head 15
7 - 721242 \varnothing 14x280 T/Head 15



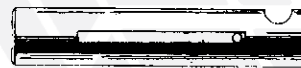
730064
9



730095
10



730108 \varnothing 28x60x50
8



720058
14



12 - 720057
13 - 720055



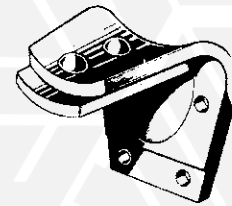
730302
11



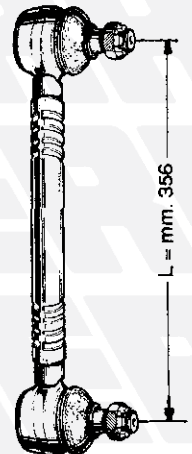
15 - 726243 mm. 2
16 - 726244 mm. 2,5
17 - 726231 mm. 3
18 - 726245 mm. 3,5



19 - 726217 mm. 2
20 - 726218 mm. 3





725070
25



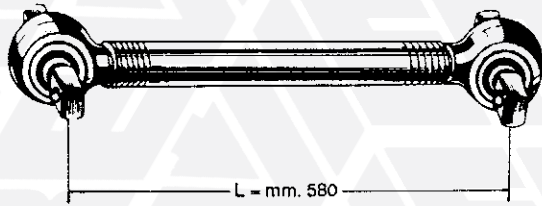
712536
26



21 - 722193 \varnothing 20x90x470
22 - 722194 \varnothing 20x90x490
23 - 722195 \varnothing 20x90x510
24 - 722196 \varnothing 20x90x530

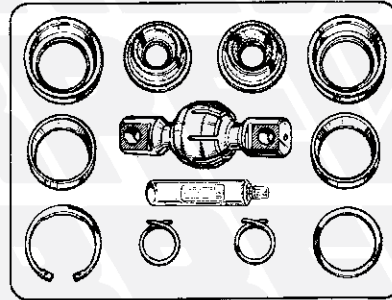
FIG. ITEM	RIF. ERREVI ERREVI REF.	DESCRIZIONE PARTICOLARI DESCRIPTION	TIPO VEHICLE MODEL	RIF. ORIG. ORIG. REF.
190.33/ .36/ .42/ .48 - 240.36/ .48  TURBOSTAR 190.24/ .26/ .30/ .32 - 240.26  TURBOTECH SOSPENSIONE POSTERIORE / REAR SUSPENSION				
1	711065	Complessivo revisione balestre / Rear spring repair kit		-
2	725524	Boccola balestra e biscottino / Spring eye and shackle bush	ø 35x45x90	42071717 4652071
3	730295	Boccola elastica fiss. barra stabilizzatrice / Rubber bush	ø 52x65x60	220.32/.36 - 240.36 TURBOTECH 4739171
4	721108	Bullone centrale c/dado 1ª Serie / Centre bolt c/w nut	ø 14x260 T/H 25x9	-
5	721109	Bullone centrale c/dado 1ª Serie / Centre bolt c/w nut	ø 14x300 T/H 25x9	-
6	721220	Bullone centrale c/dado U.T. / Centre bolt c/w nut	ø 14x250 T/H 24,5x15	-
7	721242	Bullone centrale c/dado U.T. / Centre bolt c/w nut	ø 14x280 T/H 24,5x15	-
8	730108	Estemblock sup. per supporto barra stabilizzatrice / Rubber bushing	ø 28x60x50	4601722
9	730064	Fascia in gomma barra stabilizzatrice / Rubber pad		4688153
10	730095	Fascia in gomma barra stabilizzatrice / Rubber pad (Sosp. Pneumatica / Air Suspension)		TURBOSTAR - 190.32 TURBOTECH 4735723
11	730302	Paracolpo in gomma per balestra / Rubber buffer		4715638
12	720057	Perno balestra lato posteriore / Spring pin, rear end	ø 30/35x152	4652073
13	720055	Perno balestra lato anteriore / Spring pin, front end	ø 30/35x152	4703374
14	720058	Perno biscottino / Shackle pin	ø 20x152	4652077
15	726243	Rondella c/bisello rasamento / Spring thrust washer	ø 30x63x2	-
16	726244	Rondella c/bisello rasamento / Spring thrust washer	ø 30x63x2,5	-
17	726231	Rondella c/bisello rasamento / Spring thrust washer	ø 30x63x3	4652074
18	726245	Rondella c/bisello rasamento / Spring thrust washer	ø 30x63x3,5	-
19	726217	Rondella rasamento biscottino / Shackle thrust washer	ø 36x66x2	-
20	726218	Rondella rasamento biscottino / Shackle thrust washer	ø 36x66x3	856612
21	722193	Staffa Quadra c/dadi U.T. / U bolt c/w nuts	ø 20x90x470	190.48 - 240.48 TURBOSTAR 190.24/.26/.32-240.26 TURBOTECH 42109745
22	722194	Staffa Quadra c/dadi U.T. / U bolt c/w nuts	ø 20x90x490	190.48 - 240.48 TURBOSTAR 190.24/.26/.32-240.26 TURBOTECH -
23	722195	Staffa Quadra c/dadi U.T. / U bolt c/w nuts	ø 20x90x510	190.48 - 240.48 TURBOSTAR 190.24/.26/.32-240.26 TURBOTECH -
24	722196	Staffa Quadra c/dadi U.T. / U bolt c/w nuts	ø 20x90x530	190.48 - 240.48 TURBOSTAR 190.24/.26/.32-240.26 TURBOTECH -
25	725070	Supporto al telaio appoggio balestrino / Helper spring support		4708435
26	712536	Tirante completo barra stabilizzatrice / Stabilizer bar rod (Sosp. Pneumatica / Air Suspension)		TURBOSTAR 190.32 TURBOTECH 4741171

1 SOSPENSIONE POSTERIORE PNEUMATICA / REAR AIR SUSPENSION

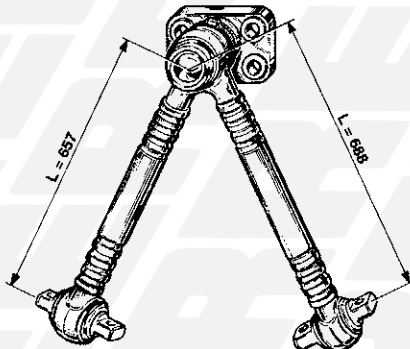


712648

1

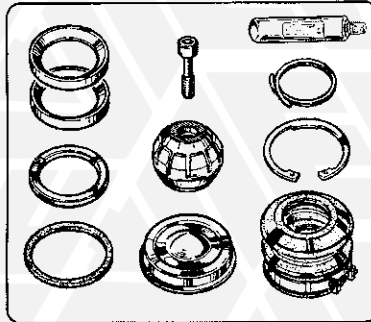


2 - 730191

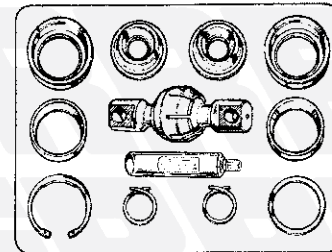


712647

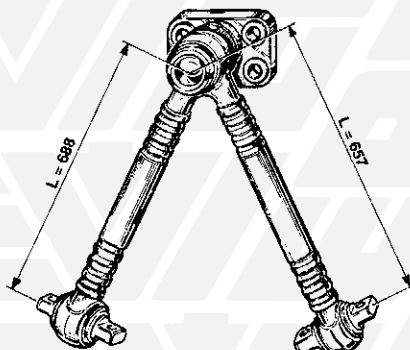
3



5 - 730206

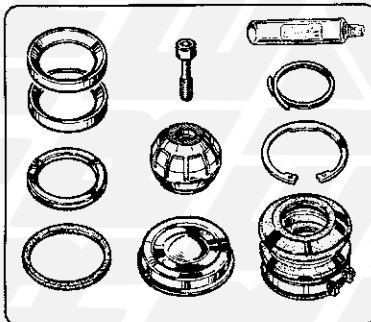


6 - 730191

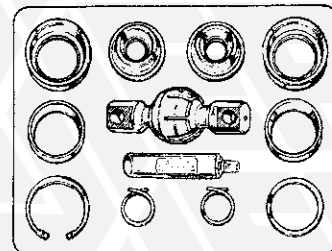


712646

4

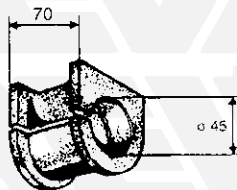


5 - 730206



6 - 730191

2



730283

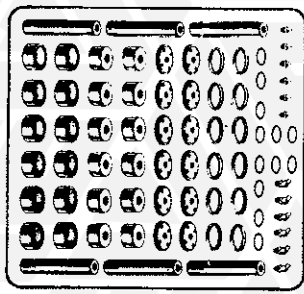
7



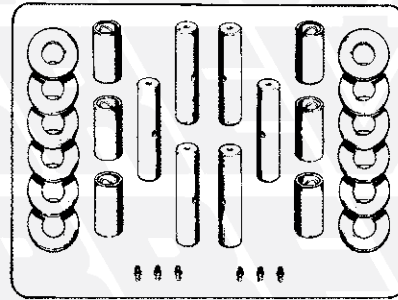
8 - 722720 \varnothing 20x90x470

FIG. ITEM	RIF. ERREVI ERREVI REF.	DESCRIZIONE PARTICOLARI DESCRIPTION	TIPO VEHICLE MODEL	RIF. ORIG. ORIG. REF.
<p>190.33/ .36 / .42 / .48</p> <p>TURBOSTAR</p> <p>① 190.32/ .36 - 220.32/ .36 - 240.36</p> <p>TURBOTECH</p> <p>220.38 PT</p> <p>SOSPENSIONE POSTERIORE "PNEUMATICA" / REAR AIR SUSPENSION</p>				
1	712648	Barra di reazione completa (tipo lemforder) / <i>Torque arm</i>		4714134 42125057 98488010
2	730191	Kit revisione barra - con perno - <i>Torque arm repair kit c/w pin</i>		2980884
3	712647	Barra di reazione angolare completa / <i>Angle torque arm</i>	TURBOSTAR - TURBOTECH	4716271
4	712646	Barra di reazione angolare completa / <i>Angle torque arm</i>	220.38 PT	4716799
5	730206	Kit revisione barra angolare - parte centrale - <i>Angle torque arm repair kit</i>		2968454
6	730191	Kit revisione barra angolare - con perno - <i>Angle torque arm repair kit c/w pin</i>		2980884
<p>② 260.36/ .38 TURBOTECH</p>				
7	730283	Boccola elastica per barra stabilizzatrice / <i>Rubber pad</i>	Ant. / <i>Front</i>	4731981
8	722720	Staffa Quadra piatta c/dadi / <i>U bolt c/w nuts</i>	∅ 20x90x470	42126907

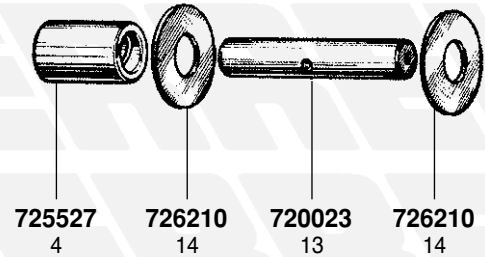
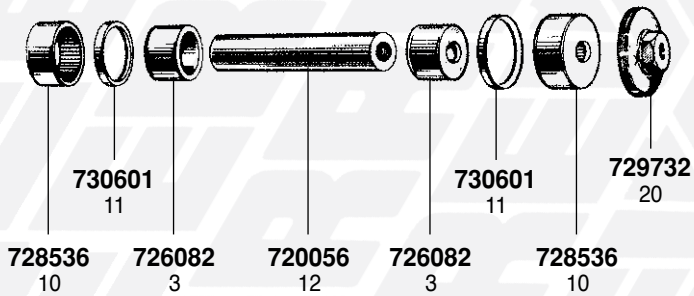
SOSPENSIONE ANTERIORE / FRONT SUSPENSION



711043
1



711064
2



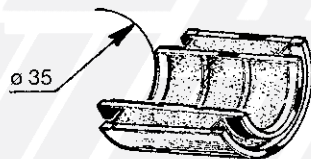
5 - 721211 \varnothing 16x195



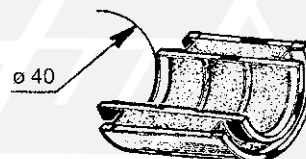
6 - 721214 \varnothing 16x205
7 - 721216 \varnothing 16x230



8 - 721125 \varnothing 12x150
9 - 721126 \varnothing 12x170



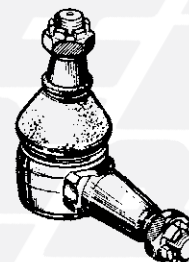
730267
15



730268
16



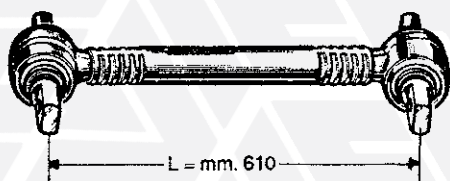
17 - 722114 \varnothing 18x80x270
18 - 722116 \varnothing 18x80x310
19 - 722191 \varnothing 18x80x225



713195
21

FIG. ITEM	RIF. ERREVI ERREVI REF.	DESCRIZIONE PARTICOLARI DESCRIPTION	TIPO VEHICLE MODEL	RIF. ORIG. ORIG. REF.
330F26/ .26H - 330F35/ .35H 330F35T/ .35HT - 330.30H/ .30HT - 330.36H SOSPENSIONE ANTERIORE / FRONT SUSPENSION				
1	711043	Completivo revisione balestre 1ª Serie <i>Front spring repair kit (Old Models)</i>		-
2	711064	Completivo revisione balestre U.T. <i>Front spring repair kit (Latest Models)</i>		-
3	726082	Boccola in acciaio perno balestra e biscottino <i>Spring eye and shackle steel bush</i>	1ª Serie	42015229
4	725527	Boccola balestra e biscottino / <i>Spring bush</i>	∅ 28x34x75,5 U.T.	42066389
5	721211	Bullone centrale c/dado / <i>Centre bolt c/w nut</i>	∅ 16x195 T/H 20x18	330F26/ .F35
6	721214	Bullone centrale c/dado / <i>Centre bolt c/w nut</i>	∅ 16x205 T/H 20x14,5	U.T.
7	721216	Bullone centrale c/dado / <i>Centre bolt c/w nut</i>	∅ 16x230 T/H 20x14,5	U.T.
8	721125	Bullone centrale balestra parabolica <i>Centre bolt c/w nut parabolic spring</i>	∅ 12x150 T/H 20x37	U.T.
9	721126	Bullone centrale balestra parabolica <i>Centre bolt c/w nut parabolic spring</i>	∅ 12x170 T/H 20x37	U.T.
10	728536	Cuscinetto a rulli perno balestra e biscottino <i>Roller bearing, spring pin</i>		1ª Serie
11	730601	Guarnizione di tenuta per cuscinetto a rulli / <i>Sealing ring</i>		1ª Serie
12	720056	Perno balestra e biscottino / <i>Spring pin</i>	∅ 25x118	1ª Serie
13	720023	Perno balestra e biscottino / <i>Spring pin</i>	∅ 28x140	U.T.
14	726210	Rondella rasamento / <i>Spring thrust washer</i>	∅ 28x60x3	U.T.
15	730267	Semiboccola barra stabilizzatrice / <i>Stabilizer bar half-bushing</i>	∅ int. 35	330.26H/ .30H/ .35H/ .36H
16	730268	Semiboccola barra stabilizzatrice / <i>Stabilizer bar half-bushing</i>	∅ int. 40	330.26H/ .30H/ .35H/ .36H
17	722114	Staffa Quadra Piatta c/dadi / <i>U bolt c/w nuts</i>	∅ 18x80x270	
18	722116	Staffa Quadra Piatta c/dadi / <i>U bolt c/w nuts</i>	∅ 18x80x310	U.T.
19	722191	Staffa balestra parabolica Quadra Piatta c/dadi <i>U bolt c/w nuts parabolic spring</i>	∅ 18x80x225	U.T.
20	729732	Tappo perno balestra e biscottino c/esagono / <i>Spring pin plug</i>		
21	713195	Testina barra stabilizzatrice / <i>Stabilizer bar ball joint</i>		330.26/ .35

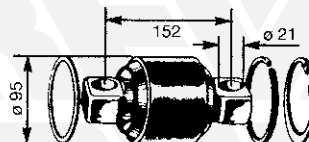
SOSPENSIONE POSTERIORE / REAR SUSPENSION



L = mm. 610

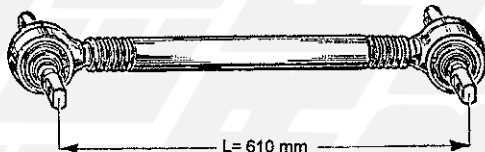
712649

1



730202

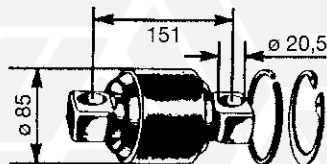
2



L = 610 mm

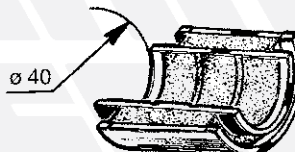
712949

3



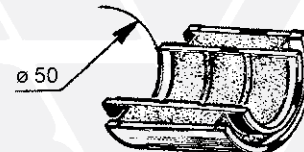
730201

4



730268

13



730314

14



5 - 721204 \varnothing 16x355



- 6 - 721133 \varnothing 16x270
- 7 - 721284 \varnothing 16x300
- 8 - 721202 \varnothing 16x310
- 9 - 721203 \varnothing 16x330
- 10 - 721280 \varnothing 16x390
- 11 - 721240 \varnothing 16x210



729045

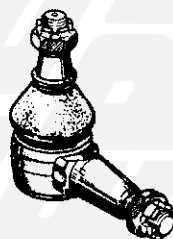
12



- 15 - 722185 \varnothing 24x100x550
- 16 - 722186 \varnothing 24x100x580



- 17 - 722200 \varnothing 24x100x140
- 18 - 722734 \varnothing 24x100x380
- 19 - 722201 \varnothing 24x100x430
- 20 - 722202 \varnothing 24x100x460
- 21 - 722188 \varnothing 24x100x485
- 22 - 722189 \varnothing 24x100x510
- 23 - 722190 \varnothing 24x100x535

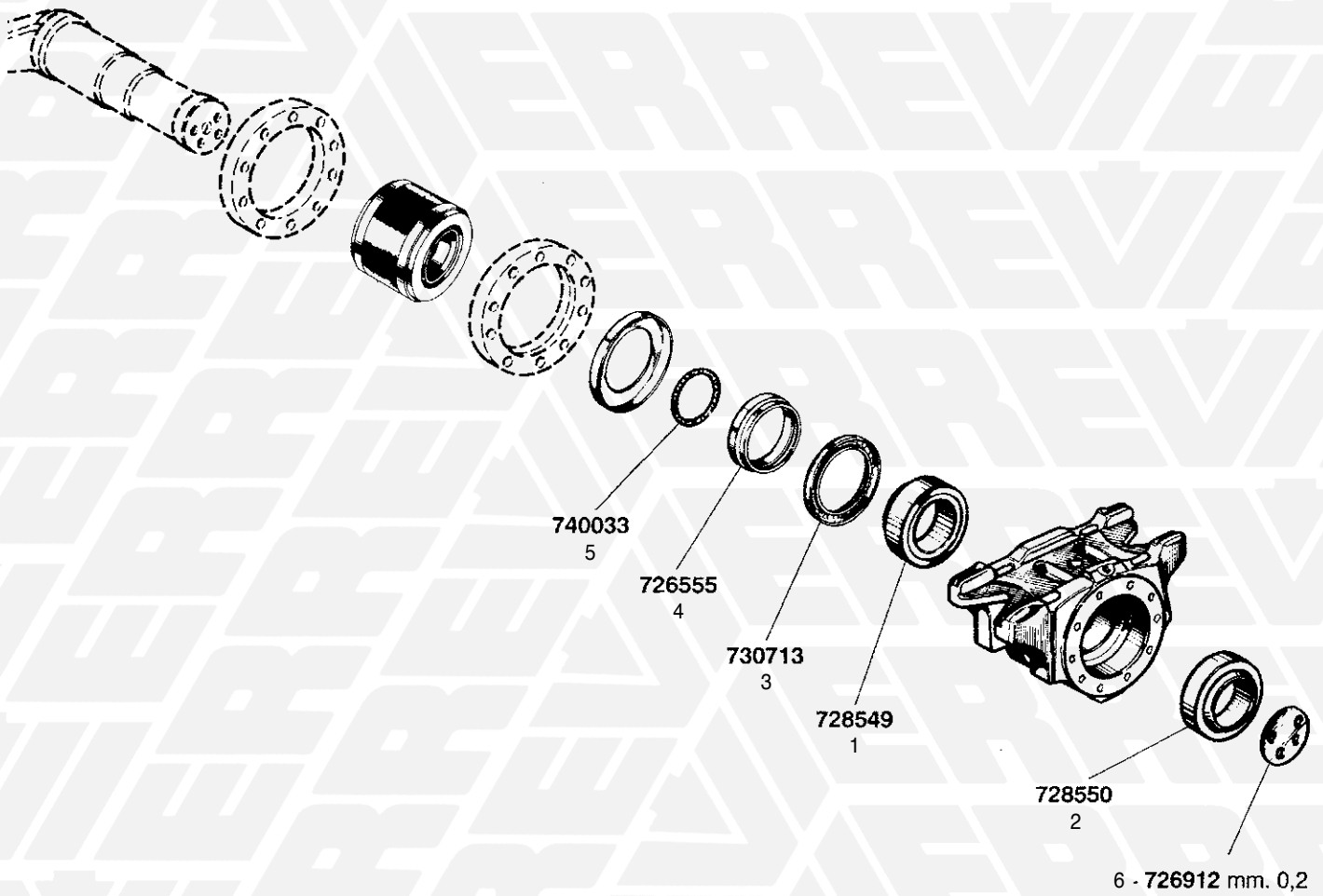


713200

24

FIG. ITEM	RIF. ERREVI ERREVI REF.	DESCRIZIONE PARTICOLARI DESCRIPTION	TIPO VEHICLE MODEL	RIF. ORIG. ORIG. REF.
330F26/ .26H - 330F35/ .35H 330F35T/ .35HT - 330.30H/ .30HT - 330.36H SOSPENSIONE POSTERIORE / REAR SUSPENSION				
1	712649	Barra di reazione completa c/teste fisse U.T. / <i>Rigid torque arm</i>		41011006 42065332
2	730202	Kit revisione barra / <i>Torque arm repair kit</i>		93192619 42493431
3	712949	Barra di reazione / <i>Torque arm</i>	L = 610 mm	42041107 41011008
4	730201	Kit revisione barra / <i>Torque arm repair kit</i>	330.30H/ .36H	93192618
5	721204	Bullone centrale c/dado / <i>Centre bolt c/w nut</i>	∅ 16x355 T/H 24x13	330 Passo A 42033989
6	721133	Bullone centrale c/dado / <i>Centre bolt c/w nut</i>	∅ 16x270 T/H 24x13	42017892
7	721284	Bullone centrale c/dado / <i>Centre bolt c/w nut</i>	∅ 16x300 T/H 24x13	330 Passo B -
8	721202	Bullone centrale c/dado / <i>Centre bolt c/w nut</i>	∅ 16x310 T/H 24x13	330 Passo B -
9	721203	Bullone centrale c/dado / <i>Centre bolt c/w nut</i>	∅ 16x330 T/H 24x13	330 Passo B -
10	721280	Bullone centrale c/dado / <i>Centre bolt c/w nut</i>	∅ 16x390 T/H 24x13	330 Passo B -
11	721240	Bullone centrale balestra parabolica c/dado <i>Centre bolt c/w nut parabolic spring</i>	∅ 16x210 T/H 24x13	330.30H/ .30HT - 330.36 2513415
12	729045	Rondella conica dado staffa balestra / <i>Cone washer</i>	∅ 25x42x8	1117519
13	730268	Semiboccola per barra stabilizzatrice / <i>Stabilizer bar half-bushing</i>	∅ int. 40	330.26H/ .30H/ .35H/ .36H 2520448
14	730314	Semiboccola per barra stabilizzatrice / <i>Stabilizer bar half-bushing</i>	∅ int. 50	330.26H/.30H/.35H/.36H 2521850
15	722185	Staffa Semitonda Piatta c/dadi / <i>U bolt c/w nuts</i>	∅ 24x100x550	330 Passo A 42042229 42033968
16	722186	Staffa Semitonda Piatta c/dadi / <i>U bolt c/w nuts</i>	∅ 24x100x580	330 Passo A -
17	722200	Staffa bal. parabolica Semitonda Piatta c/dadi <i>U bolt c/w nuts parabolic spring</i>	∅ 24x100x410	330.30H/ .30HT - 330.36 42052121
18	722734	Staffa Semitonda Piatta c/dadi / <i>U bolt c/w nuts</i>	∅ 24x100x380	330.26/ .30/ .36 42065777
19	722201	Staffa bal. parabolica Semitonda Piatta c/dadi <i>U bolt c/w nuts parabolic spring</i>	∅ 24x100x430	330.30H/ .30HT - 330.36 -
20	722202	Staffa bal. parabolica Semitonda Piatta c/dadi <i>U bolt c/w nuts parabolic spring</i>	∅ 24x100x460	330.30H/ .30HT - 330.36 -
21	722188	Staffa Semitonda Piatta c/dadi / <i>U bolt c/w nuts</i>	∅ 24x100x485	330 Passo B 2533683 42052124 42065780
22	722189	Staffa Semitonda Piatta c/dadi / <i>U bolt c/w nuts</i>	∅ 24x100x510	330 Passo B -
23	722190	Staffa Semitonda Piatta c/dadi / <i>U bolt c/w nuts</i>	∅ 24x100x535	330 Passo B -
24	713200	Testa a snodo fissaggio barra stabilizzatrice / <i>Stabilizer bar ball joint</i>		330.26/ .30/ .35/ .35T/ .36 2460515

1 BILANCIERE / EQUALIZER ASSY



2 BILANCIERE / EQUALIZER ASSY

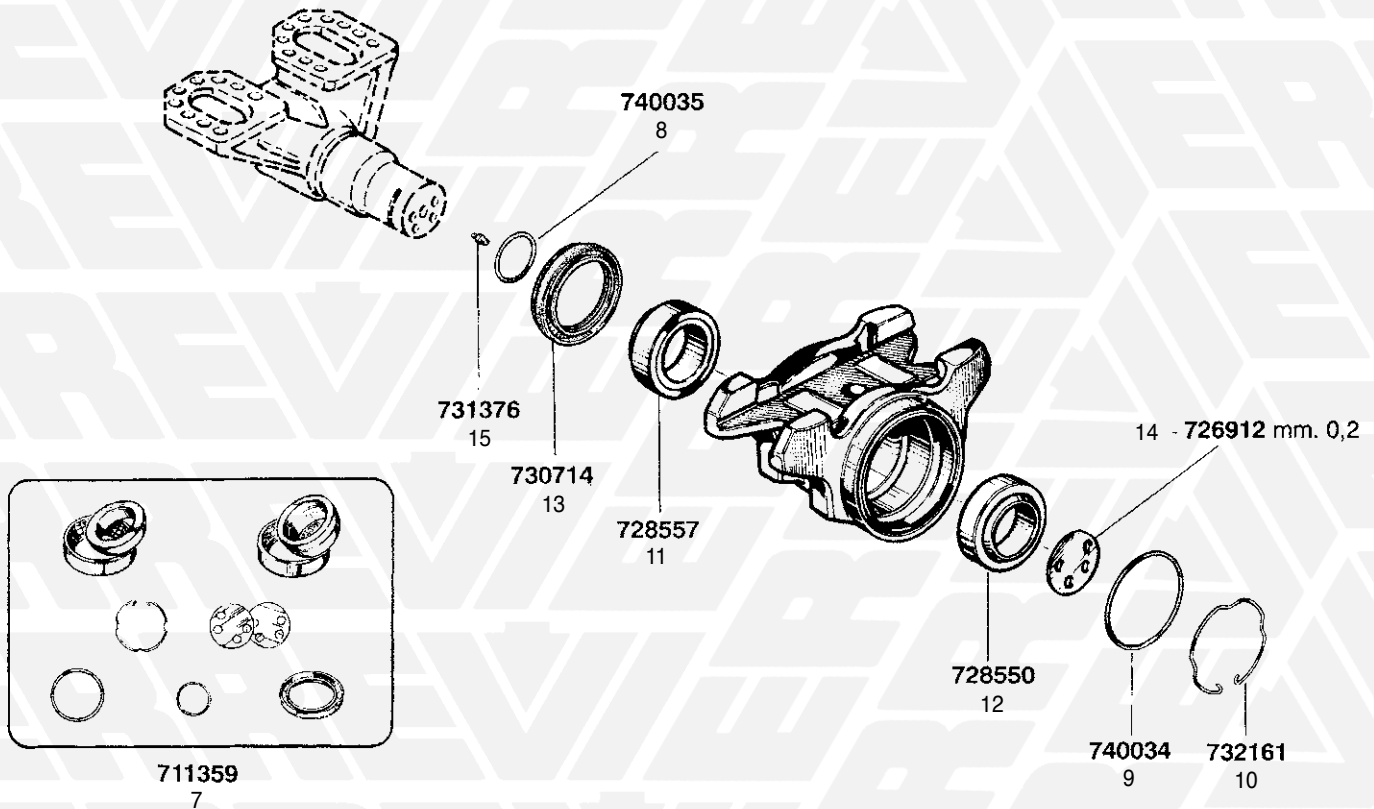
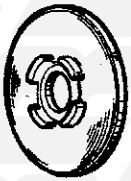


FIG. ITEM	RIF. ERREVI ERREVI REF.	DESCRIZIONE PARTICOLARI DESCRIPTION	TIPO VEHICLE MODEL	RIF. ORIG. ORIG. REF.
330F26/ .26H - 330F35/ .35H 330F35T/ .35HT - 330.30H/ .30HT - 330.36H ① BILANCIERE 1ª SERIE / EQUALIZER ASSY (EARLY MODELS)				
1	728549	Cuscinetto interno / <i>Inner bearing</i>	ø 105x160x39	42001243
2	728550	Cuscinetto esterno / <i>Outer bearing</i>	ø 103x160x39	42001244
3	730713	Paraolio interno / <i>Seal, inner bearing</i>	ø 125x160x15	42031684
4	726555	Anello di appoggio per cuscinetto interno <i>Thrust ring, inner bearing</i>		2521853
5	740033	Guarnizione di tenuta per anello / <i>O-ring</i>		1170592
6	726912	Spessore di registro / <i>Shim</i>	mm. 0,2	2521862
② BILANCIERE U. TIPO EQUALIZER ASSY (LATEST MODELS)				
7	711359	Serie completa revisione bilanciere (1 sola parte) composta da: Rocker beam repair kit (Services one end only), inclusive of:		-
8	740035	(1) Anello di tenuta / <i>Seal</i>	ø 105x6	1166134
9	740034	(1) Anello di tenuta / <i>Seal</i>	ø 170x5	42050613
10	732161	(1) Anello a molla / <i>Snap ring</i>		42051017
11	728557	(1) Cuscinetto interno / <i>Inner bearing</i>	ø 105x160x60	42043068
12	728550	(1) Cuscinetto esterno / <i>Outer bearing</i>	ø 103x160x39	42001244
13	730714	(1) Paraolio interno / <i>Inner oil seal</i>	ø 150x180x22	42043079
14	726912	(1) Spessore di registro / <i>Shim</i>	mm. 0,2	2521862
15	731376	(1) Ingrassatore / <i>Grease nipple</i>	M8x1	1120693

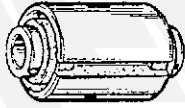
SOSPENSIONE ANTERIORE / FRONT SUSPENSION



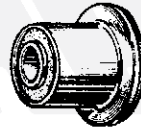
1 - 726355 \varnothing 16,5x65 sp./th. 4
2 - 726358 \varnothing 21x78 sp./th. 4



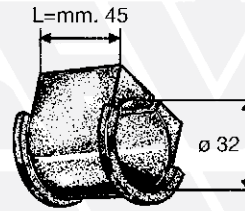
730906
3



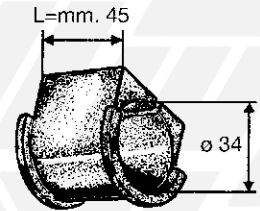
730215 - 730253
4 6



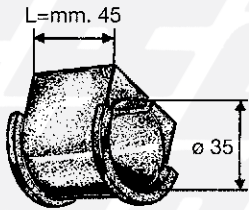
730216
5



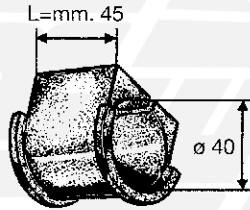
730299
7



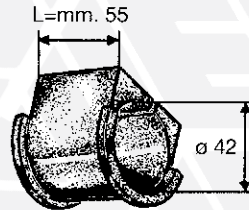
730301
8



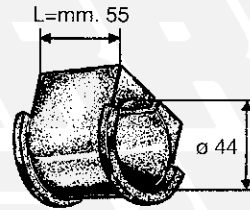
730260
9



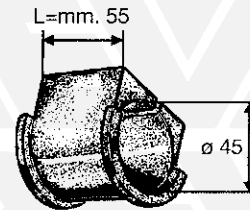
730259
10



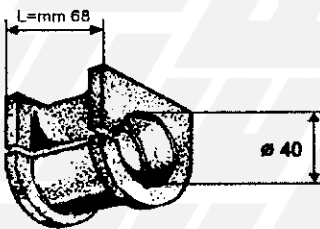
730300
11



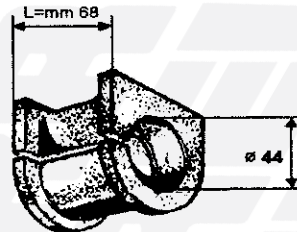
730298
12



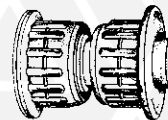
730261
13



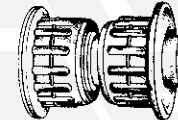
730397
14



730398
15



730390
16



730396
17



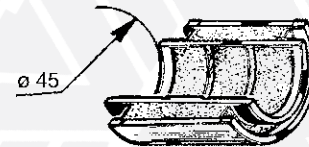
730405
18



19 - 721260 \varnothing 12x115 T/Head 20 H. 24



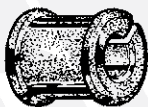
20 - 721263 \varnothing 12x100 T/Head 20 H. 28
21 - 721264 \varnothing 12x120 T/Head 20 H. 28



730293
26



730289
27



730318
29



730010 730114
23 24



730250
28



729649
22



721084
25

FIG. ITEM	RIF. ERREVI ERREVI REF.	DESCRIZIONE PARTICOLARI DESCRIPTION		TIPO VEHICLE MODEL	RIF. ORIG. ORIG. REF.
EUROCARGO - EUROCARGO "TECTOR"					
SOSPENSIONE ANTERIORE / FRONT SUSPENSION					
1	726355	Anello rasamento occhio bal. e piastra biscottino c/intagli <i>Thrust ring spring eye and shackle plate with grooves</i>	∅ 16,5x65x4		98414015 98465948
2	726358	Anello rasamento occhio bal. e piastra biscottino c/intagli <i>Thrust ring spring eye and shackle plate with grooves</i>	∅ 21x78x4		98413938 98465949
3	730906	Boccola in gomma ammortizzatore / <i>Shockabsorber rubber bush</i>	∅ 20x50x21		93159607 503131528
4	730215	Boccola elastica per balestra e supporto bal. (lato post.) / <i>Silentblock</i>	∅ 16,5x48x74	Veicoli leggeri / <i>Light vehicles</i>	98413847
5	730216	Boccola elastica per balestra e supporto bal. (lato post.) - U.T. <i>Rubber bush</i>	∅ 16,5x46x40	Veicoli leggeri / <i>Light vehicles</i>	98482540
6	730253	Boccola elastica occhio bal. e supporto bal. (lato post.) / <i>Silentblock</i>	∅ 20,3x57,5x84		98413939
7	730299	Boccola elastica per staffa fiss. barra stabilizzatrice / <i>Rubber bush</i>	∅ int. 32	60E10/E12/E14 } 65E10/E12/E14 } EUROCARGO 75E13/E15 E.CARGO "TECTOR"	8125527
8	730301	Boccola elastica per staffa fiss. barra stabilizzatrice / <i>Rubber bush</i>	∅ int. 34	75E15 EUROCARGO	8125528
9	730260	Boccola elastica per staffa fiss. barra stabilizzatrice / <i>Rubber bush</i>	∅ int. 35		8127910
10	730259	Boccola elastica per staffa fiss. barra stabilizzatrice / <i>Rubber bush</i>	∅ int. 40		4792127
11	730300	Boccola elastica per staffa fiss. barra stabilizzatrice / <i>Rubber bush</i>	∅ int. 42	120E15/E18/E23 } 120E17/E21 } EUROCARGO 130E18/E24/E28 } "TECTOR"	98415468
12	730298	Boccola elastica per staffa fiss. barra stabilizzatrice / <i>Rubber bush</i>	∅ int. 44	120E15/E18/E23 } 130E15/E18/E23 } EUROCARGO 150E15/E18/E23/E27 } 260E23-320E27 } 130E18/E24 } EUROCARGO 130E21/E28 } "TECTOR"	98415469
13	730261	Boccola elastica per staffa fiss. barra stabilizzatrice / <i>Rubber bush</i>	∅ int. 45		98431946
14	730397	Boccola elastica fissaggio barra stabilizzatrice <i>Rubber bush</i>	∅ int. 40		98488528
15	730398	Boccola elastica fissaggio barra stabilizzatrice <i>Rubber bush</i>	∅ int. 44		98488743
16	730390	Boccola balestra <i>Spring bush</i>	∅ 16,5x45x80	EUROCARGO 100E18 EUROCARGO "TECTOR" 75E13/E15/E17/E18 100E18/E21	504011462
17	730396	Boccola balestra <i>Spring bush</i>	∅ 20x55x90	EUROCARGO 140E18/E22/E25 150E18/E25/E30 160E18/E22/E24/E25/E30 180E25/E28/E30	504139797
18	730405	Boccola balestra <i>Spring bush</i>	∅ 20x58x80	EUROCARGO 120EL15/EL18/EL21 EUROCARGO "TECTOR" 100E17/E21	500356747
19	721260	Bullone centrale c/dado / <i>Centre bolt c/w nut</i>	∅ 12x115 T/H 20x24		-
20	721263	Bullone centrale c/dado / <i>Centre bolt c/w nut</i>	∅ 12x100 T/H 20x28		98400324 4839146
21	721264	Bullone centrale c/dado / <i>Centre bolt c/w nut</i>	∅ 12x120 T/H 20x28		98455866
22	729649	Dado c/collarino bloccaggio perno silentblock barra stabilizzatrice <i>Flanged nut</i>	M20x2,5		16750725 16750721
23	730010	Estemblock p/braccio oscillante barra stabilizzatrice / <i>Rubber bushing</i>	∅ 20x46x42		4606624
24	730114	Estemblock p/braccio oscillante barra stabilizzatrice / <i>Rubber bushing</i>	∅ 20x46x55		4791448
25	721084	Perno bloccaggio silentblock barra stabilizzatrice / <i>Bolt</i>	∅ 28x62		42120135
26	730293	Semiboccola barra stabilizzatrice / <i>Stabilizer bar half bushing</i>	∅ int. 45	EUROCARGO	98469634
27	730289	Semiboccola barra stabilizzatrice / <i>Stabilizer bar half bushing</i>	∅ int. 48	EUROCARGO-E.CARGO "TECTOR"	98469635
28	730250	Silentblock per barra stabilizzatrice / <i>Silentblock, stabilizer bar</i>	∅ 28x62,2x50		8162306
29	730318	Silentblock inf. ammortizzatore / <i>Silentblock</i>	∅ 20x40x40	EUROCARGO-E.CARGO "TECTOR"	93163099

SOSPENSIONE ANTERIORE / FRONT SUSPENSION



- 1 - **722510** \varnothing 14x70x130
- 2 - **722511** \varnothing 14x70x140
- 3 - **722512** \varnothing 14x70x150
- 4 - **722513** \varnothing 14x70x170
- 5 - **722514** \varnothing 14x70x190



- 6 - **722695** \varnothing 14x70x210
- 7 - **722696** \varnothing 14x70x230
- 8 - **722697** \varnothing 14x70x250



- 13 - **722706** \varnothing 18x80x140
- 14 - **722707** \varnothing 18x80x155
- 15 - **722708** \varnothing 18x80x170
- 16 - **722709** \varnothing 18x80x190



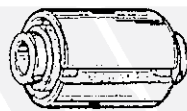
- 9 - **722710** \varnothing 18x80x225
- 10 - **722711** \varnothing 18x80x240
- 11 - **722712** \varnothing 18x80x255
- 12 - **722713** \varnothing 18x80x270

FIG. ITEM	RIF. ERREVI ERREVI REF.	DESCRIZIONE PARTICOLARI DESCRIPTION		TIPO VEHICLE MODEL	RIF. ORIG. ORIG. REF.
Segue / Cont'd: EUROCARGO - EUROCARGO "TECTOR" SOSPENSIONE ANTERIORE / FRONT SUSPENSION					
1	722510	Staffa Quadra c/dadi lato post. / U bolt c/w nuts	ø 14x70x130	balestra parabolica/parabolic spring	8125393
2	722511	Staffa Quadra c/dadi lato ant. / U bolt c/w nuts	ø 14x70x140		98412590
3	722512	Staffa Quadra c/dadi / U bolt c/w nuts	ø 14x70x150	balestra parabolica/parabolic spring	4842643
4	722513	Staffa Quadra c/dadi / U bolt c/w nuts	ø 14x70x170	balestra parabolica/parabolic spring	-
5	722514	Staffa Quadra c/dadi / U bolt c/w nuts	ø 14x70x190		-
6	722695	Staffa Quadra c/dadi lato post./ U bolt c/w nuts	ø 14x70x210		8125401 98412589
7	722696	Staffa Quadra c/dadi lato post./ U bolt c/w nuts	ø 14x70x230		4842644
8	722697	Staffa Quadra c/dadi lato post./ U bolt c/w nuts	ø 14x70x250		-
9	722710	Staffa Quadra c/dadi lato ant. / U bolt c/w nuts	ø 18x80x225	balestra parabolica/parabolic spring	98415955
10	722711	Staffa Quadra c/dadi lato ant. / U bolt c/w nuts	ø 18x80x240	balestra parabolica/parabolic spring	98415956
11	722712	Staffa Quadra c/dadi lato ant. / U bolt c/w nuts	ø 18x80x255	balestra parabolica/parabolic spring	98415957
12	722713	Staffa Quadra c/dadi lato ant. / U bolt c/w nuts	ø 18x80x270	balestra parabolica/parabolic spring	98425903
13	722706	Staffa Quadra c/dadi lato post./ U bolt c/w nuts	ø 18x80x140	balestra parabolica/parabolic spring	98415952
14	722707	Staffa Quadra c/dadi lato post./ U bolt c/w nuts	ø 18x80x155	balestra parabolica/parabolic spring	98415953
15	722708	Staffa Quadra c/dadi lato post./ U bolt c/w nuts	ø 18x80x170	balestra parabolica/parabolic spring	98415954
16	722709	Staffa Quadra c/dadi lato post./ U bolt c/w nuts	ø 18x80x190	balestra parabolica/parabolic spring	98455872

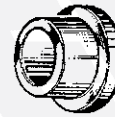
SOSPENSIONE POSTERIORE / REAR SUSPENSION



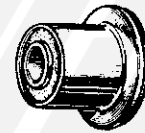
1 - 726355 \varnothing 16,5x65 sp./th. 4
2 - 726358 \varnothing 21x78 sp./th. 4



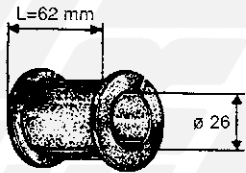
730215 730253
3 4



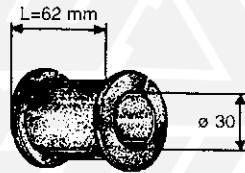
730224
5



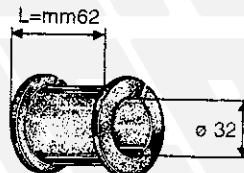
730216
6



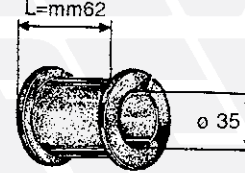
730296
7



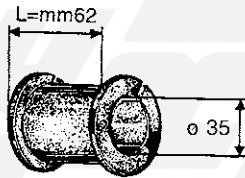
730248
8



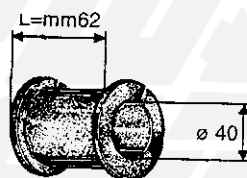
730266
9



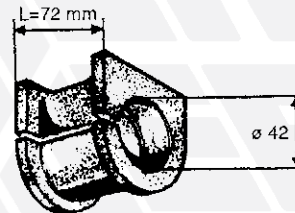
730265
11



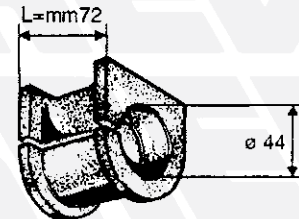
730343
12



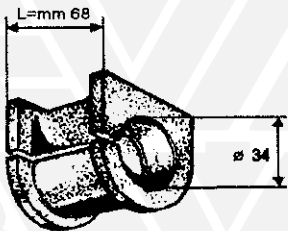
730264
13



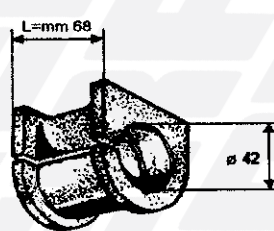
730249
14



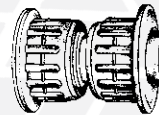
730262
16



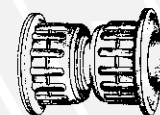
730399
10



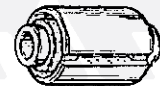
730404
15



730390
17



730396
18



730405
19



20 - 721266 \varnothing 12x120 T/Head 20 H. 11
21 - 721267 \varnothing 12x140 T/Head 20 H. 11



22 - 721268 \varnothing 12x165 T/Head 20 H. 11
23 - 721269 \varnothing 12x200 T/Head 20 H. 11
24 - 721270 \varnothing 12x230 T/Head 20 H. 11



25 - 721272 \varnothing 12x130 T/Head 20 H. 14
26 - 721273 \varnothing 12x240 T/Head 20 H. 14



730308
31



729649
27



721084
32



727062
28



730108
29



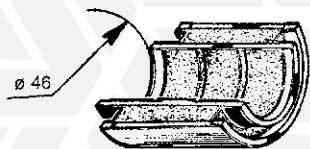
730114
30



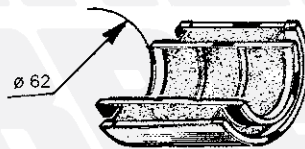
730250
33

FIG. ITEM	RIF. ERREVI ERREVI REF.	DESCRIZIONE PARTICOLARI DESCRIPTION		TIPO VEHICLE MODEL	RIF. ORIG. ORIG. REF.
EUROCARGO - EUROCARGO "TECTOR"					
SOSPENSIONE POSTERIORE / REAR SUSPENSION					
1	726355	Anello rasamento occhio bal. e piastra biscottino c/intagli <i>Thrust ring spring eye and shackle plate with grooves</i>	∅ 16,5x65x4		98414015 98465948
2	726358	Anello rasamento occhio bal. e piastra biscottino c/intagli <i>Thrust ring spring eye and shackle plate with grooves</i>	∅ 21x78x4		98413938 98465949
3	730215	Boccola elastica balestra e supporto balestra (lato post.) / <i>Silentblock</i>	∅ 16,5x48x74	Veicoli leggeri / <i>Light vehicles</i>	98413847
4	730253	Boccola elastica balestra e supporto balestra (lato post.) / <i>Silentblock</i>	∅ 20,3x57,5x84		98413939
5	730224	Boccola in gomma barra stabilizzatrice / <i>Rubber bush</i>	∅ 32,5x42/52x27		8127423
6	730216	Boccola elastica occhio bal. e supporto bal. (lato post.) - U.T. <i>Rubber bush</i>	∅ 16,5x46x40	Veicoli leggeri / <i>Light vehicles</i>	98482540
7	730296	Boccola elastica per staffa fiss. barra stabilizzatrice / <i>Rubber bush</i>	∅ 26x54x62	60E14-65E12/E14 } EUROCARGO 75E12/E14/E15 } EUROCARGO 75E13/E15 } "TECTOR" 75E17/E18 }	4848464
8	730248	Boccola elastica per staffa fiss. barra stabilizzatrice / <i>Rubber bush</i>	∅ int. 30	Veicoli leggeri / <i>Light vehicles</i>	8125490
9	730266	Boccola elastica per staffa fiss. barra stabilizzatrice / <i>Rubber bush</i>	∅ int. 32		8125491
10	730399	Boccola elastica fissaggio barra stabilizzatrice <i>Rubber bush</i>	∅ int. 34	EUROCARGO 95E15/E21 EUROCARGO "TECTOR" 100E18/E21	4849258
11	730265	Boccola elastica per staffa fiss. barra stabilizzatrice / <i>Rubber bush</i>	∅ int. 35		8125492
12	730343	Boccola elastica per staffa fiss. barra stabilizzatrice / <i>Rubber bush</i>	∅ int. 35		8127381
13	730264	Boccola elastica per staffa fiss. barra stabilizzatrice / <i>Rubber bush</i>	∅ int. 40		8127383
14	730249	Boccola elastica per staffa fiss. barra stabilizzatrice / <i>Rubber bush</i>	∅ int. 42	Veicoli pesanti / <i>Heavy-duty vehicles</i>	98407169
15	730404	Boccola elastica fissaggio barra stabilizzatrice / <i>Rubber bush</i>	∅ int. 42		98451947
16	730262	Boccola elastica per staffa fiss. barra stabilizzatrice / <i>Rubber bush</i>	∅ int. 44		98407168
17	730390	Boccola balestra <i>Spring bush</i>	∅ 16,5x45x80	EUROCARGO 100E18 EUROCARGO "TECTOR" 75E13/E15/E17/E18 100E18/E21	504011462
18	730396	Boccola balestra <i>Spring bush</i>	∅ 20x55x90	EUROCARGO 140E18/E22/E25 150E18/E25/E30 160E18/E22/E24/E25/E30 180E25/E28/E30	504139797
19	730405	Boccola balestra <i>Silentblock</i>	∅ 20x58x80	EUROCARGO 120EL15/EL18/EL21 EUROCARGO "TECTOR" 100E17/E21	500356747
20	721266	Bullone centrale c/dado / <i>Centre bolt c/w nut</i>	∅ 12x120 T/H 20x11		4849142 98419256
21	721267	Bullone centrale c/dado / <i>Centre bolt c/w nut</i>	∅ 12x140 T/H 20x11		4824590
22	721268	Bullone centrale c/dado / <i>Centre bolt c/w nut</i>	∅ 12x165 T/H 20x11		4844287
23	721269	Bullone centrale c/dado / <i>Centre bolt c/w nut</i>	∅ 12x200 T/H 20x11		-
24	721270	Bullone centrale c/dado / <i>Centre bolt c/w nut</i>	∅ 12x230 T/H 20x11		4847072
25	721272	Bullone centrale c/dado / <i>Centre bolt c/w nut</i>	∅ 12x130 T/H 20x14		8597568
26	721273	Bullone centrale c/dado / <i>Centre bolt c/w nut</i>	∅ 12x240 T/H 20x14		4833843
27	729649	Dado c/collarino blocc. perno silentblock barra stabilizzatrice / <i>Flanged nut</i>	M20x2,5		16750725
28	727062	Distanziale per boccola barra stabilizzatrice posteriore / <i>Spacer, rear</i>	∅ 20x32x53		8127422
29	730108	Estemblock supporto sostegno barra stabilizzatrice / <i>Rubber bushing</i>	∅ 28x60x50		4601722
30	730114	Estemblock supporto sostegno barra stabilizzatrice / <i>Rubber bushing</i>	∅ 20x46x55		4791448
31	730308	Paracolpo in gomma per balestra / <i>Rubber buffer</i>		150E15H/E18H } EUROCARGO 150E21H/E23H }	98461032
32	721084	Perno bloccaggio silentblock barra stabilizzatrice / <i>Bolt</i>	∅ 28x62		42120135
33	730250	Silentblock barra stabilizzatrice / <i>Silentblock, stabilizer bar</i>	∅ 28x62,2x50		8162306

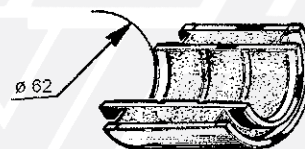
SOSPENSIONE POSTERIORE / REAR SUSPENSION



730294
1



730290
2



730291
3



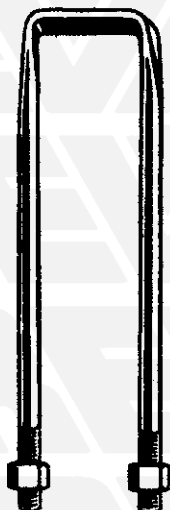
- 4 - 722672 \varnothing 18x70x300
- 5 - 722673 \varnothing 18x70x325
- 6 - 722674 \varnothing 18x70x340
- 7 - 722675 \varnothing 18x70x360
- 8 - 722676 \varnothing 18x70x380
- 9 - 722677 \varnothing 18x70x400
- 10 - 722703 \varnothing 18x70x420
- 11 - 722704 \varnothing 18x70x440



- 12 - 722716 \varnothing 18x70x345
- 13 - 722717 \varnothing 18x70x365
- 14 - 722718 \varnothing 18x70x420



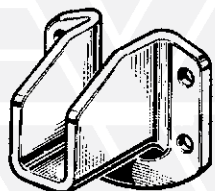
- 15 - 722739 \varnothing 20x70x300
- 16 - 722740 \varnothing 20x70x340



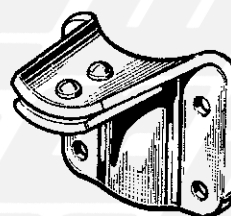
17 - 722736 \varnothing 22x70x360



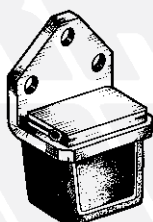
- 18 - 722698 \varnothing 22x80x360
- 19 - 722699 \varnothing 22x80x380
- 20 - 722700 \varnothing 22x80x400
- 21 - 722701 \varnothing 22x80x420
- 22 - 722702 \varnothing 22x80x440
- 23 - 722213 \varnothing 22x80x465
- 24 - 722715 \varnothing 22x80x485
- 25 - 722725 \varnothing 22x80x510
- 26 - 722729 \varnothing 22x80x540



725076
27



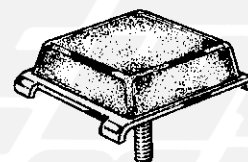
725077
28



730966
29



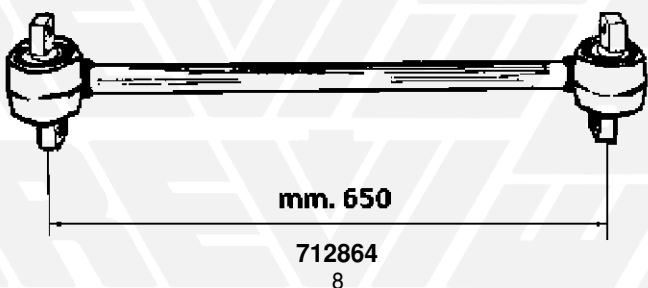
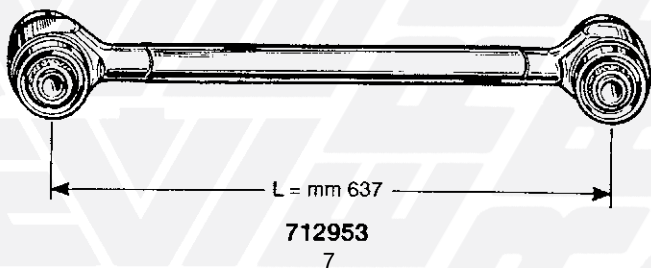
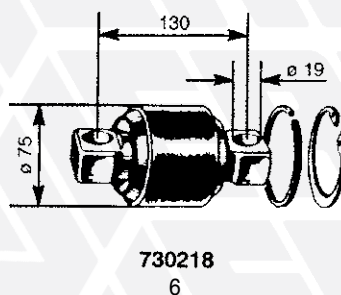
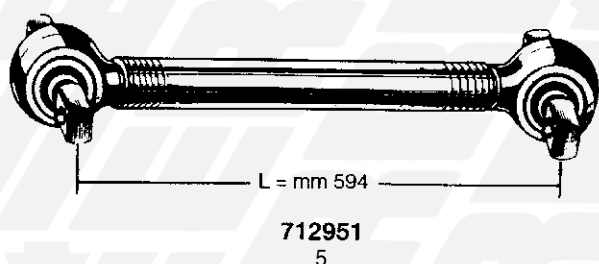
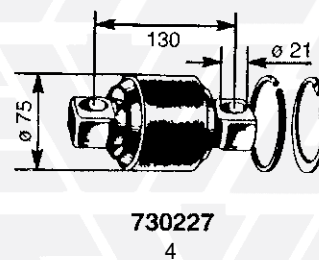
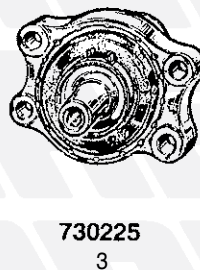
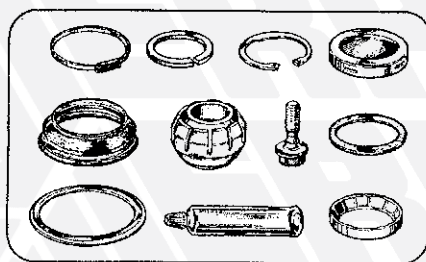
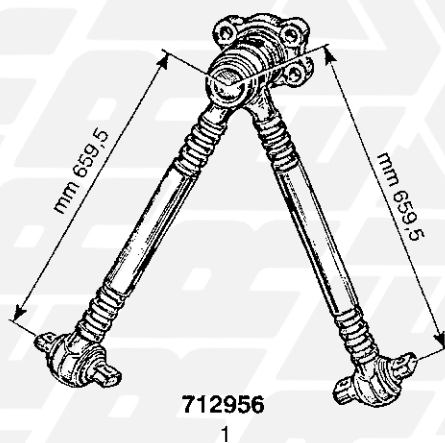
730306
30



730307
31

FIG. ITEM	RIF. ERREVI ERREVI REF.	DESCRIZIONE PARTICOLARI DESCRIPTION	TIPO VEHICLE MODEL	RIF. ORIG. ORIG. REF.
Segue / Cont'd: EUROCARGO - EUROCARGO "TECTOR"				
SOSPENSIONE POSTERIORE / REAR SUSPENSION				
1	730294	Semiboccola barra stabilizzatrice <i>Stabilizer bar half-bushing</i>	∅ int. 46	98456259
2	730290	Semiboccola barra stabilizzatrice <i>Stabilizer bar half-bushing</i>	∅ int. 62	98444831
3	730291	Semiboccola barra stabilizzatrice <i>Stabilizer bar half-bushing</i>	∅ int. 62	98444833
4	722672	Staffa Quadra c/dadi / U bolt c/w nuts	∅ 18x70x300	4844264
5	722673	Staffa Quadra c/dadi / U bolt c/w nuts	∅ 18x70x325	98413833
6	722674	Staffa Quadra c/dadi / U bolt c/w nuts	∅ 18x70x340	-
7	722675	Staffa Quadra c/dadi / U bolt c/w nuts	∅ 18x70x360	-
8	722676	Staffa Quadra c/dadi / U bolt c/w nuts	∅ 18x70x380	-
9	722677	Staffa Quadra c/dadi / U bolt c/w nuts	∅ 18x70x400	-
10	722703	Staffa Quadra c/dadi / U bolt c/w nuts	∅ 18x70x420	-
11	722704	Staffa Quadra c/dadi / U bolt c/w nuts	∅ 18x70x440	-
12	722716	Staffa Quadra piatta c/dadi / U bolt c/w nuts	∅ 18x70x345	98438605
13	722717	Staffa Quadra piatta c/dadi / U bolt c/w nuts	∅ 18x70x365	-
14	722718	Staffa Quadra piatta c/dadi / U bolt c/w nuts	∅ 18x70x420	98438606
15	722739	Staffa Quadra c/dadi / U bolt c/w nuts	∅ 20x70x300	EUROCARGO "TECTOR" 75E13/E15/E17/E18 100E17/E18/E21
16	722740	Staffa Quadra c/dadi / U bolt c/w nuts	∅ 20x70x340	
17	722736	Staffa Quadra piatta c/dadi / U bolt c/w nuts	∅ 22x70x360	120EL15/ EL18/ EL21
18	722698	Staffa Quadra piatta c/dadi / U bolt c/w nuts	∅ 22x80x360	4829343
19	722699	Staffa Quadra piatta c/dadi / U bolt c/w nuts	∅ 22x80x380	4853856
20	722700	Staffa Quadra piatta c/dadi / U bolt c/w nuts	∅ 22x80x400	-
21	722701	Staffa Quadra piatta c/dadi / U bolt c/w nuts	∅ 22x80x420	-
22	722702	Staffa Quadra piatta c/dadi / U bolt c/w nuts	∅ 22x80x440	-
23	722213	Staffa Quadra piatta c/dadi / U bolt c/w nuts	∅ 22x80x465	4836008
24	722715	Staffa Quadra piatta c/dadi / U bolt c/w nuts	∅ 22x80x485	4847078
25	722725	Staffa Quadra piatta c/dadi / U bolt c/w nuts	∅ 22x80x510	-
26	722729	Staffa Quadra piatta c/dadi / U bolt c/w nuts	∅ 22x80x540	98460063
27	725076	Supporto appoggio balestrino / <i>Helper spring bracket</i>	80E15/E18/E21 - 100E15/E18/E21	98410103
28	725077	Supporto appoggio balestrino / <i>Helper spring bracket</i>	120E15/E18 - 130E15/E18 150E18	98413967
29	730966	Tassello appoggio balestra / <i>Rubber buffer</i>	EUROCARGO 170E18/E23/E27 EUROCARGO "Tector" 180E21/ E24/E28	98404961
30	730306	Tassello in gomma per controfolgia balestra / <i>Rubber buffer</i>	Veicoli leggeri / <i>Light vehicles</i>	98401286
31	730307	Tassello in gomma per controfolgia balestra / <i>Rubber buffer</i>	Veicoli pesanti / <i>Heavy-duty vehicles</i>	98405404

SOSPENSIONE PNEUMATICA / AIR SUSPENSION



10 - 713403 fil. D. / RH thread H 8x1,25
11 - 713404 fil. S. / LH thread H 8x1,25



12 - 713420 fil. D. / RH thread H 8x1,25
13 - 713421 fil. S. / LH thread H 8x1,25

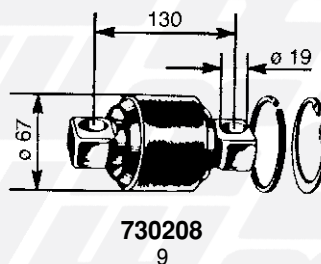
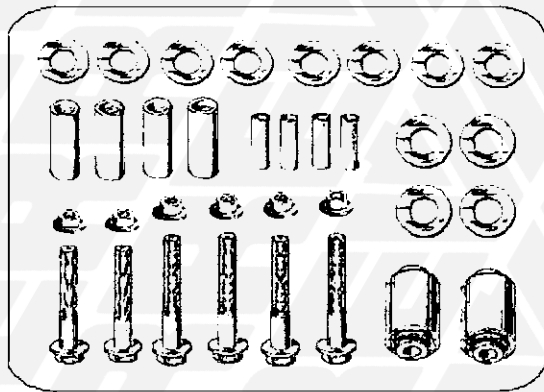


FIG. ITEM	RIF. ERREVI ERREVI REF.	DESCRIZIONE PARTICOLARI DESCRIPTION	TIPO VEHICLE MODEL	RIF. ORIG. ORIG. REF.
EUROCARGO				
SOSPENSIONE PNEUMATICA / AIR SUSPENSION				
1	712956	Barra di reazione angolare / <i>Angle torque arm</i>	U.T. Veicoli pesanti <i>Heavy-duty vehicles</i>	504064007 41042092 41028599
2	730226	Kit per barra di reazione angolare - PARTE CENTRALE <i>Angle torque arm repair kit</i>		93161958 93162239
3	730225	Piastra attacco barra angolare / <i>Angle torque arm head assy</i>		93161959
4	730227	Kit per barra di reazione angolare / <i>Angle torque arm repair kit</i>		93161960
5	712951	Barra di reazione / <i>Torque arm</i>	U.T. Veicoli pesanti <i>Heavy-duty vehicles</i>	41035951 41214462 41272429 8137027 98472466
6	730218	Kit per barra di reazione angolare / <i>Angle bar repair kit</i>		93192361 93161637
7	712953	Barra di reazione completa / <i>Torque arm</i>	Veicoli leggeri / <i>Light vehicles</i>	93163964
8	712864	Barra di reazione posteriore / <i>Torque arm, rear</i>	L=650 mm	504108885
9	730208	Kit per barra di reazione <i>Torque arm repair kit</i>		93163617
10	713403	Testina a snodo inf. filetto D. per asta valvola livellatrice <i>Ball joint (RH thread), bottom</i>	M8x1,25	4525854 2997004 5006234802
11	713404	Testina a snodo sup. filetto S. per asta valvola livellatrice <i>Ball joint (LH thread), top</i>	M8x1,25	4525855
12	713420	Testina a snodo sup. filetto D. per asta valvola livellatrice <i>Ball joint (RH thread), top</i>	M8x1,25	41019116
13	713421	Testina a snodo inf. filetto S. per asta valvola livellatrice <i>Ball joint (LH thread), bottom</i>	M8x1,25	41019115

SOSPENSIONE ANTERIORE / FRONT SUSPENSION



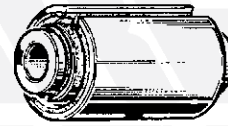
711717
1



730906
4



2 - 726357 \varnothing 37x88x3,5
3 - 726317 \varnothing 37x88x4,8



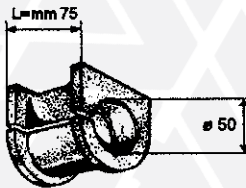
730221 - 730253
5 13



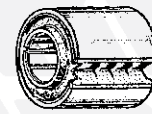
732740
6



730383
14



730410
15



730353
16



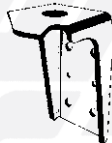
717073
20



717075
21



724534
22



724535
23



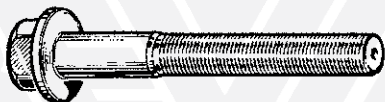
720229
24



720234
25



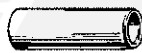
712987
32



9 - 720217 \varnothing 20x1,5x135
10 - 720218 \varnothing 20x1,5x145



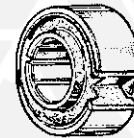
729276
7



727058
8



726358
11



730254
12



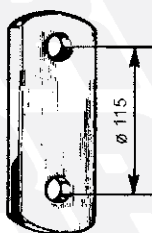
17 - 721277 \varnothing 14x105 T/Head 22 H. 24
18 - 721278 \varnothing 14x120 T/Head 22 H. 24
19 - 721279 \varnothing 14x140 T/Head 22 H. 24



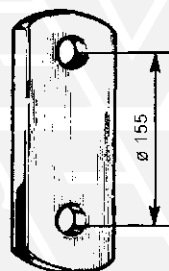
729649
27



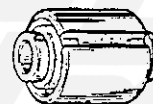
721084
26



724733
28



724732
29



730250
30

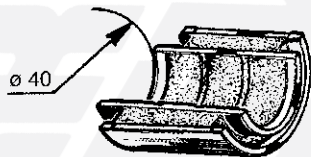


730318
31

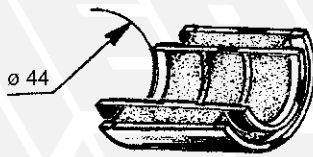
FIG. ITEM	RIF. ERREVI ERREVI REF.	DESCRIZIONE PARTICOLARI DESCRIPTION	TIPO VEHICLE MODEL	RIF. ORIG. ORIG. REF.	
EUROTECH - EUROTECH "CURSOR" - EUROSTAR - EUROSTAR "CURSOR" EUROTRAKKER - EUROTRAKKER "CURSOR" - STRALIS - TRAKKER					
SOSPENSIONE ANTERIORE / FRONT SUSPENSION					
1	711717	Complessivo revisione balestre anteriori composto da: Pin and bushes, repair kit	EUROTECH - EUROTECH "CURSOR" EUROSTAR - EUROSTAR "CURSOR" EUROTRAKKER - STRALIS	-	
2	726357	(4) Anello rasamento occhio balestra - lato ANT. <i>Thrust ring spring eye, front end</i>	∅ 37x88x3.5	8138938	
3	726317	(8) Anello rasamento occhio balestra - lato POST. <i>Thrust ring spring eye, rear end</i>	∅ 37x88x4.8	41015480	
4	730906	Boccola in gomma ammortizzatore / <i>Shockabsorber rubber bush</i>	∅ 20x50x21	EUROTECH - EUROTECH "Cursor" EUROSTAR - EUROSTAR "Cursor" EUROTRAKKER - STRALIS EUROTRAKKER "Cursor"	93159607 503131528
5	730221	(2) Boccola elastica / <i>Rubber bush</i>	∅ 20.4x62.3x97	8160686	
6	732740	(4) Boccola occhio bal. e supporto balestra - lato POST. <i>Spring eye bush, rear end</i>	∅ 37.2x60.5x86.5	41042198 41015384	
7	729276	(6) Dado perno balestra / <i>Spring pin nut</i>	M20x1.5	8161193	
8	727058	(4) Distanziale / <i>Spring eye spacer</i>	∅ 20.5x37x97	8138899	
9	720217	(2) Perno balestra - lato ANT. / <i>Spring pin, front end</i>	M20x1.5 L=135	8161190	
10	720218	(4) Perno balestra - lato POST / <i>Spring pin, rear end</i>	M20x1.5 L=145	8161191	
11	726358	Anello rasamento occhio balestra e piastra biscottino c/intagli <i>Thrust ring spring eye and shackle plate with grooves</i>	∅ 21x78x4	EUROTECH	98465949
12	730254	Boccola elastica per perno bal. e piastra biscottino <i>Rubber bush</i>	∅ 36,6x64,5x32,6	EUROTRAKKER EUROTRAKKER "CURSOR" STRALIS - TRAKKER	8162280
13	730253	Boccola elastica per balestra e supporto bal. (lato post.) <i>Silentblock</i>	∅ 20,3x57,5x84	EUROTECH	98413939
14	730383	Boccola elastica barra stabilizzatrice <i>Silentblock, stabilizer bar</i>	∅ 28x60x44/50	EUROTRAKKER STRALIS - TRAKKER	41218902 412288750 500336108
15	730410	Boccola elastica fissaggio barra stabilizzatrice <i>Rubber bush</i>	∅ int. 50	EUROTECH "CURSOR" EUROSTAR "CURSOR" - STRALIS	99482437
16	730353	Boccola elastica / <i>Silentblock</i>	∅ 36x61,2x90	2997221	
17	721277	Bullone centrale c/dado / <i>Centre bolt c/w nut</i>	∅ 14x105 T/H 22x24	42126365 41801602	
18	721278	Bullone centrale c/dado / <i>Centre bolt c/w nut</i>	∅ 14x120 T/H 22x24	-	
19	721279	Bullone centrale c/dado / <i>Centre bolt c/w nut</i>	∅ 14x140 T/H 22x24	-	
20	717073	Forcella attacco ammortizzatore <i>Shock absorber fork connection</i>		41013677 8139585	
21	717075	Forcella attacco ammortizzatore anteriore <i>Front shock absorber fork connection</i>		EUROTRAKKER - TRAKKER	41225200
22	724534	Mensola attacco ammortizzatore anteriore <i>Front shock absorber bracket</i>		EUROTRAKKER "Cursor" STRALIS - TRAKKER	41271902 41028123
23	724535	Mensola attacco ammortizzatore anteriore <i>Front shock absorber bracket</i>		STRALIS	41271903 41028124
24	720229	Perno balestra 2° asse, lato anteriore <i>Spring pin</i>	∅ 37x220	EUROTRAKKER - TRAKKER EUROTRAKKER "CURSOR"	41003056
25	720234	Perno balestra / <i>Spring pin</i>	∅ 18x178	STRALIS - TRAKKER	41003115
26	721084	Perno bloccaggio silentblock barra stabilizzatrice / <i>Bolt</i>	∅ 28x62	42120135	
27	729649	Dado c/collarino blocc. perno silentblock barra stabilizzatrice <i>Flanged nut</i>	M20x2,5	16750725	
28	724733	Piastra biscottino / <i>Shackle plate</i>	(interasse fori mm.115)	8134539	
29	724732	Piastra biscottino / <i>Shackle plate</i>	(interasse fori mm.155)	EUROTECH - EUROSTAR	8166109
30	730250	Silentblock p/barra stabilizzatrice / <i>Silentblock stabilizer bar</i>	∅ 28x62,2x50	8162306	
31	730318	Silentblock inf. ammortizzatore / <i>Silentblock</i>	∅ 20x40x40	93163099	
32	712987	Tirante barra stabilizzatrice con silentblock / <i>Stabilizer bar rod</i>		41000480	

I marchi ed i nominativi dei costruttori come pure i riferimenti originali sono esposti a solo titolo indicativo in quanto i nostri particolari non sono originali
 Manufacturer's names and part numbers in this catalogue are used for cross reference purposes only and do not imply anything about the origin or manufacturer of product.

SOSPENSIONE ANTERIORE / FRONT SUSPENSION



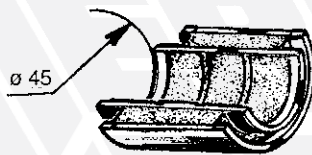
730268
1



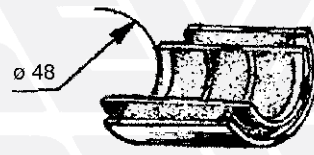
730281
2



732723
5



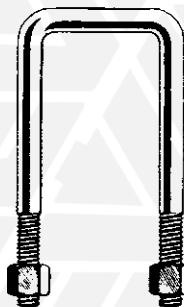
730293
3



730289
4



- 6 - 723062 \varnothing 20x80x190
- 7 - 723064 \varnothing 20x80x220
- 8 - 723065 \varnothing 20x80x250



- 9 - 722060 \varnothing 20x90x145
- 10 - 722061 \varnothing 20x90x160
- 11 - 722063 \varnothing 20x90x180
- 12 - 722064 \varnothing 20x90x200
- 13 - 722065 \varnothing 20x90x220
- 14 - 722067 \varnothing 20x90x230
- 15 - 722066 \varnothing 20x90x240
- 16 - 722068 \varnothing 20x90x260
- 17 - 723722 \varnothing 20x90x280



18 - 722211 \varnothing 20x90x360



730315
19



730316
20

FIG. ITEM	RIF. ERREVI ERREVI REF.	DESCRIZIONE PARTICOLARI DESCRIPTION		TIPO VEHICLE MODEL	RIF. ORIG. ORIG. REF.
EUROTECH - EUROTECH "CURSOR" EUROSTAR - EUROSTAR "CURSOR" EUROTRAKKER - EUROTRAKKER "CURSOR" STRALIS - TRAKKER					
SOSPENSIONE ANTERIORE / FRONT SUSPENSION					
1	730268	Semiboccola per barra stabilizzatrice / <i>Stabilizer bar half-bushing</i>	ø int 40	EUROTECH - EUROSTAR EUROTRAKKER EUROTRAKKER "CURSOR" TRAKKER	2520448
2	730281	Semiboccola barra stabilizzatrice / <i>Stabilizer bar half-bushing</i>	ø int. 44		8189831
3	730293	Semiboccola barra stabilizzatrice / <i>Stabilizer bar half-bushing</i>	ø int. 45	EUROTECH	98469634
4	730289	Semiboccola barra stabilizzatrice / <i>Stabilizer bar half-bushing</i>	ø int. 48		98469635
5	732723	Spessore foglie balestra parabolica <i>Parabolic spring distance piece</i>		EUROTECH - EUROSTAR-STRALIS	42052764
6	723062	Staffa Quadra c/dadi / <i>U bolt c/w nuts</i>	ø 20x80x190	EUROTECH	4818052
7	723064	Staffa Quadra c/dadi / <i>U bolt c/w nuts</i>	ø 20x80x220	EUROTECH	98412802
8	723065	Staffa Quadra c/dadi / <i>U bolt c/w nuts</i>	ø 20x80x250	EUROTECH	-
9	722060	Staffa Quadra c/dadi / <i>U bolt c/w nuts</i>	ø 20x90x145	EUROTECH - EUROTECH "CURSOR" EUROSTAR - EUROSTAR "CURSOR" STRALIS	42109737
10	722061	Staffa Quadra c/dadi / <i>U bolt c/w nuts</i>	ø 20x90x160		-
11	722063	Staffa Quadra c/dadi / <i>U bolt c/w nuts</i>	ø 20x90x180		42109739 42109740
12	722064	Staffa Quadra c/dadi / <i>U bolt c/w nuts</i>	ø 20x90x200		4704297
13	722065	Staffa Quadra c/dadi / <i>U bolt c/w nuts</i>	ø 20x90x220		4733570 42109742
14	722067	Staffa Quadra c/dadi / <i>U bolt c/w nuts</i>	ø 20x90x230		-
15	722066	Staffa Quadra c/dadi / <i>U bolt c/w nuts</i>	ø 20x90x240		42125361
16	722068	Staffa Quadra c/dadi / <i>U bolt c/w nuts</i>	ø 20x90x260		42127025
17	723722	Staffa Quadra c/dadi / <i>U bolt c/w nuts</i>	ø 20x90x280		-
18	722211	Staffa Quadra c/dadi / <i>U bolt c/w nuts</i>	ø 20x90x360	EUROTRAKKER EUROTRAKKER "CURSOR"	42127029
19	730315	Tassello distanziale per foglia balestra - Lato ANT. <i>Spring buffer, front</i>		EUROTECH-EUROTECH "CURSOR" EUROSTAR-EUROSTAR "CURSOR" STRALIS	41032459
20	730316	Tassello distanziale per foglia balestra - Lato POST. <i>Spring buffer, rear</i>		EUROTECH-EUROTECH "CURSOR" EUROSTAR-EUROSTAR "CURSOR" STRALIS	41034160

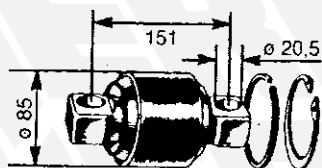
SOSPENSIONE POSTERIORE / REAR SUSPENSION



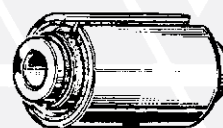
726357
1



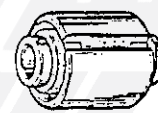
726358
2



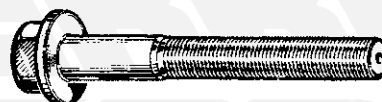
730201
3



730253 - 730223
4 5



730250
23



720219
20



729276
13



729649
14



721084
21



727059
15



7 - 721267 \varnothing 12x140 T/Head 20 H. 11
8 - 721268 \varnothing 12x165 T/Head 20 H. 11
9 - 721269 \varnothing 12x200 T/Head 20 H. 11
10 - 721281 \varnothing 12x300 T/Head 20 H. 11



11 - 721274 \varnothing 16x135 T/Head 25 H. 11
12 - 721276 \varnothing 16x190 T/Head 25 H. 11



730383
6



730284
16



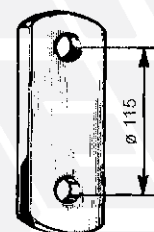
730302
17



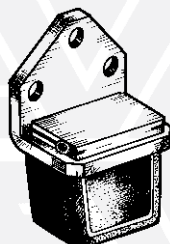
730308
18



730309
19



724733
22



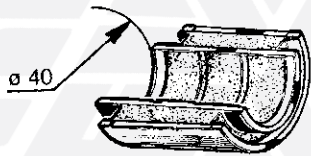
730966
24



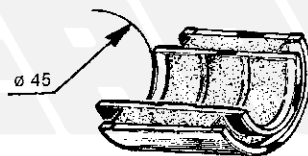
712999
25

FIG. ITEM	RIF. ERREVI ERREVI REF.	DESCRIZIONE PARTICOLARI DESCRIPTION	TIPO VEHICLE MODEL	RIF. ORIG. ORIG. REF.
EUROTECH - EUROTECH "CURSOR" EUROSTAR - EUROSTAR "CURSOR" STRALIS SOSPENSIONE POSTERIORE / REAR SUSPENSION				
1	726357	Anello rasamento occhio balestra e piastra biscottino <i>Thrust ring spring eye and shackle plate</i>	∅ 37x88x3,5	8138938
2	726358	Anello rasamento occhio balestra e piastra biscottino c/intagli <i>Thrust ring spring eye and shackle plate</i>	∅ 21x78x4	EUROTECH 98465949
3	730201	Kit revisione barra (42041107) / <i>Torque arm repair kit</i>		EUROSTAR - EUROTECH 93192618 EUROTECH "CURSOR" - STRALIS
4	730253	Boccola elastica per balestra e supporto bal. (lato POST.) <i>Silentblock</i>	∅ 20,3x57,5x84	EUROTECH 98413939
5	730223	Boccola elastica perno balestra e supporto bal. (lato POST.) <i>Silentblock</i>	∅ 20,4x62,3x106	EUROSTAR - EUROTECH 8160687 EUROTECH "CURSOR" - STRALIS
6	730383	Boccola elastica barra stabilizzatrice <i>Silentblock, stabilizer bar</i>	∅ 28x60x44/50	STRALIS 41218902 41288750 500336108
7	721267	Bullone centrale c/dado / <i>Centre bolt c/w nut</i>	∅ 12x140 T/H 20x11	EUROTECH 4824590
8	721268	Bullone centrale c/dado / <i>Centre bolt c/w nut</i>	∅ 12x165 T/H 20x11	EUROTECH -
9	721269	Bullone centrale c/dado / <i>Centre bolt c/w nut</i>	∅ 12x200 T/H 20x11	EUROTECH -
10	721281	Bullone centrale c/dado / <i>Centre bolt c/w nut</i>	∅ 12x300 T/H 20x11	EUROTECH -
11	721274	Bullone centrale c/dado / <i>Centre bolt c/w nut</i>	∅ 16x135 T/H 25x11	EUROSTAR - EUROTECH 16623921 EUROTECH "CURSOR" - STRALIS
12	721276	Bullone centrale c/dado / <i>Centre bolt c/w nut</i>	∅ 16x190 T/H 25x11	EUROSTAR - EUROTECH - EUROTECH "CURSOR" - STRALIS
13	729276	Dado perno balestra / <i>Spring pin nut</i>	M20x1,5 H.22 - CH.30	8161193
14	729649	Dado c/collarino bloccaggio perno silentblock barra stabilizzatrice / <i>Flanged nut</i>	M20x2,5	16750725 16750721
15	727059	Distanziale occhio balestra / <i>Spring eye spacer</i>	∅ 20,5x37x107	EUROSTAR - EUROTECH 8138900 EUROTECH "CURSOR" - STRALIS
16	730284	Paracolpi per foglie balestre / <i>Spring buffer</i>		EUROSTAR - EUROTECH 41006350 EUROTECH "CURSOR" - STRALIS
17	730302	Paracolpo in gomma per balestra / <i>Rubber buffer</i>		EUROTECH - EUROSTAR 4715638
18	730308	Paracolpo in gomma per balestra / <i>Rubber buffer</i>		EUROTECH 98461032
19	730309	Paracolpo in gomma per balestra / <i>Rubber buffer</i>		EUROTECH - EUROSTAR 8138611
20	720219	Perno bal. e piastra biscottino / <i>Spring pin and shackle plate</i>	∅ 20x1,5x155	EUROSTAR - EUROTECH 8161192 EUROTECH "CURSOR" - STRALIS
21	721084	Perno bloccaggio silentblock barra stabilizzatrice / <i>Bolt</i>	∅ 28x62	42120135
22	724733	Piastra biscottino / <i>Shackle plate</i>	(interasse fori mm.115)	8134539
23	730250	Silentblock barra stabilizzatrice / <i>Silentblock stabilizer bar</i>	∅ 28x62,2x50	8162306
24	730966	Tassello appoggio balestra / <i>Rubber buffer</i>		EUROTECH 180E24/E27/E30/E34 98404961 190E24/E27/E30 - 400E30/E34
25	712999	Tirante per barra stabilizzatrice posteriore <i>Thrust rod, rear</i>		41007812

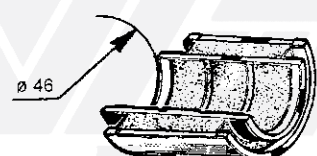
SOSPENSIONE POSTERIORE / REAR SUSPENSION



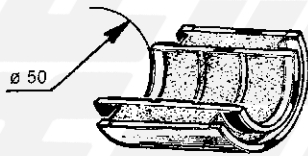
730268
1



730292
2



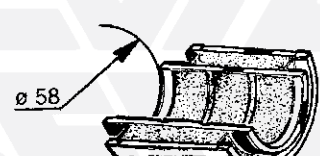
730294
3



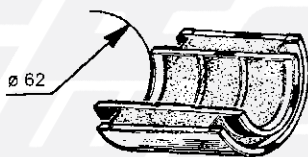
730314
4



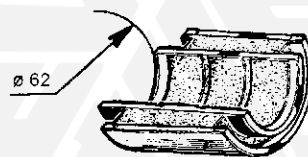
730280
5



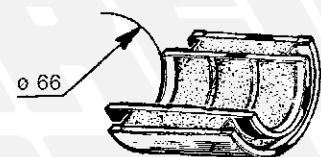
730271
6



730290
7



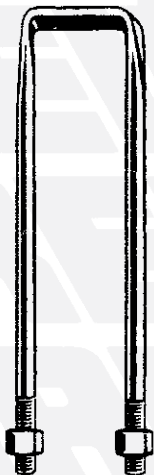
730291
8



730288
9



729311
10



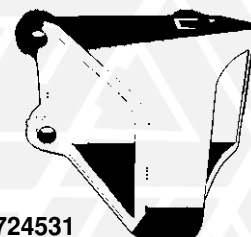
- 11 - 722699 \varnothing 22x80x380
- 12 - 722700 \varnothing 22x80x400
- 13 - 722701 \varnothing 22x80x420
- 14 - 722702 \varnothing 22x80x440
- 15 - 722715 \varnothing 22x80x485
- 16 - 722725 \varnothing 22x80x510
- 17 - 722729 \varnothing 22x80x540



- 18 - 722727 \varnothing 20x100x425
- 19 - 722216 \varnothing 20x100x520



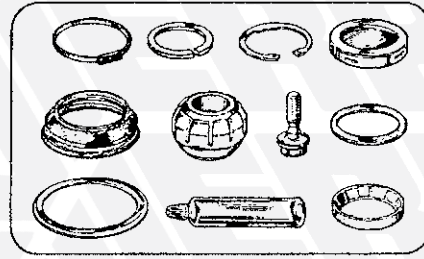
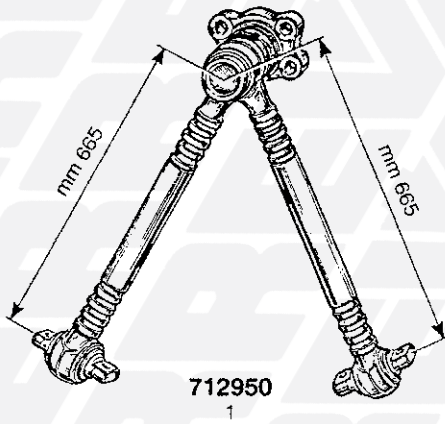
- 20 - 722214 \varnothing 24x100x330
- 21 - 722215 \varnothing 24x100x360



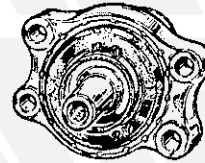
724531
22

FIG. ITEM	RIF. ERREVI ERREVI REF.	DESCRIZIONE PARTICOLARI DESCRIPTION		TIPO VEHICLE MODEL	RIF. ORIG. ORIG. REF.
EUROTECH - EUROTECH "CURSOR" EUROSTAR - EUROSTAR "CURSOR" STRALIS SOSPENSIONE POSTERIORE / REAR SUSPENSION					
1	730268	Semiboccola barra stabilizzatrice / Stabilizer bar half-bushing	ø int. 40	EUROTECH - EUROSTAR	2520448
2	730292	Semiboccola barra stabilizzatrice / Stabilizer bar half-bushing	ø int. 45	EUROTECH - EUROSTAR	2521482
3	730294	Semiboccola barra stabilizzatrice / Stabilizer bar half-bushing	ø int. 46	EUROTECH	98456259
4	730314	Semiboccola barra stabilizzatrice / Stabilizer bar half-bushing	ø int. 50	EUROSTAR - EUROTECH EUROTECH "CURSOR" - STRALIS	2521850
5	730280	Semiboccola barra stabilizzatrice / Stabilizer bar half-bushing	ø int. 55		2521481
6	730271	Semiboccola barra stabilizzatrice / Stabilizer bar half-bushing	ø int. 58		41270883 8169892
7	730290	Semiboccola barra stabilizzatrice / Stabilizer bar half-bushing	ø int. 62	EUROTECH	98444831
8	730291	Semiboccola barra stabilizzatrice / Stabilizer bar half-bushing	ø int. 62	EUROTECH	98444833
9	730288	Semiboccola barra stabilizzatrice / Stabilizer bar half-bushing	ø int. 66	EUROTECH - E.TECH "CURSOR" EUROSTAR - E.STAR "CURSOR" STRALIS	41015581
10	729311	Dado staffa / U bolt nut	M24x2 H.36 CH.36	EUROSTAR - EUROTECH EUROTECH "CURSOR" - STRALIS	-
11	722699	Staffa Quadra piatta c/dadi / U bolt c/w nuts	ø 22x80x380	EUROTECH	4853856
12	722700	Staffa Quadra piatta c/dadi / U bolt c/w nuts	ø 22x80x400	EUROTECH	98410638
13	722701	Staffa Quadra piatta c/dadi / U bolt c/w nuts	ø 22x80x420	EUROTECH	-
14	722702	Staffa Quadra piatta c/dadi / U bolt c/w nuts	ø 22x80x440	EUROTECH	-
15	722715	Staffa Quadra piatta c/dadi / U bolt c/w nuts	ø 22x80x485	EUROTECH	-
16	722725	Staffa Quadra piatta c/dadi / U bolt c/w nuts	ø 22x80x510	EUROTECH	-
17	722729	Staffa Quadra piatta c/dadi / U bolt c/w nuts	ø 22x80x540	EUROTECH	-
18	722727	Staffa Quadra c/dadi / U bolt c/w nuts	ø 20x100x425	EUROSTAR - EUROTECH EUROTECH "CURSOR" - STRALIS	-
19	722216	Staffa Quadra c/dadi / U bolt c/w nuts	ø 20x100x520	EUROTECH - EUROTECH "CURSOR" STRALIS	8138270
20	722214	Staffa semitonda piatta c/dadi / U bolt c/w nuts	ø 24x100x330	EUROSTAR - EUROTECH EUROTECH "CURSOR" - STRALIS	42079550
21	722215	Staffa semitonda piatta c/dadi / U bolt c/w nuts	ø 24x100x360	EUROSTAR - EUROTECH EUROTECH "CURSOR" - STRALIS	42074994
22	724531	Supporto guida balestra posteriore / Spring bracket, rear		EUROTECH - EUTOTECH "Cursor" EUROSTAR - EUROSTAR "Cursor"	8160830 8164042

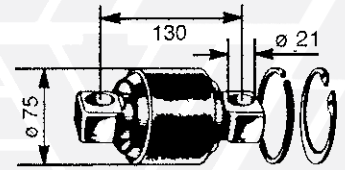
SOSPENSIONE PNEUMATICA / AIR SUSPENSION



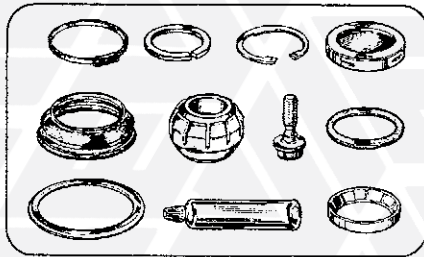
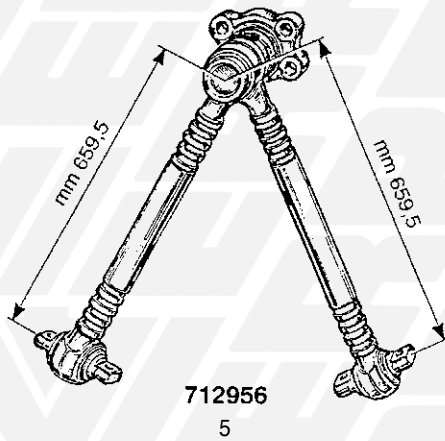
730226
2



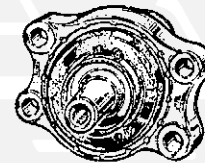
730225
3



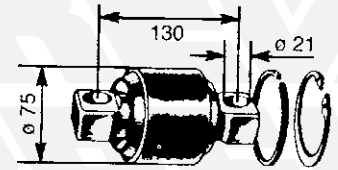
730227
4



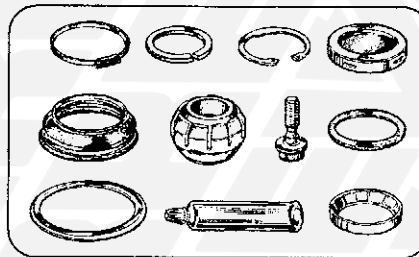
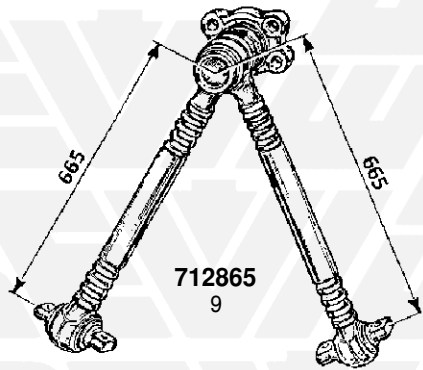
730226
6



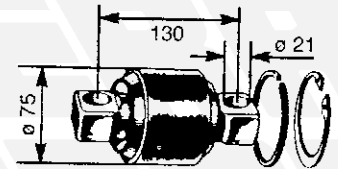
730225
7



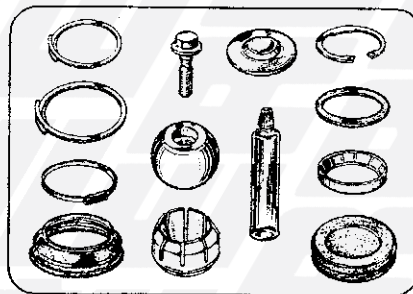
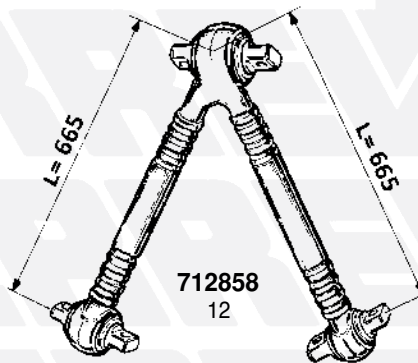
730227
8



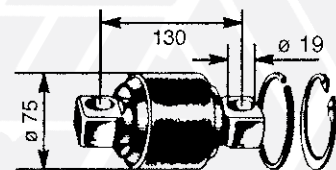
730226
11



730227
10



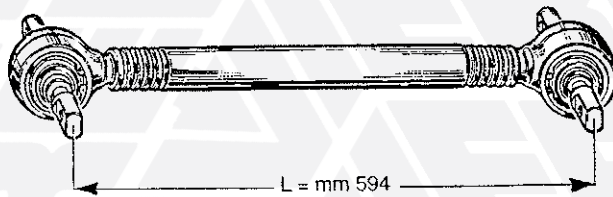
730219
13



730218
14

FIG. ITEM	RIF. ERREVI ERREVI REF.	DESCRIZIONE PARTICOLARI DESCRIPTION	TIPO VEHICLE MODEL	RIF. ORIG. ORIG. REF.
EUROTECH - EUROTECH "CURSOR" EUROSTAR - EUROSTAR "CURSOR" STRALIS SOSPENSIONE PNEUMATICA / AIR SUSPENSION				
1	712950	Barra di reazione angolare U.T. / <i>Angle torque arm</i>		41042050 41034479 41028598 41028600
2	730226	Kit revisione barra angolare - PARTE CENTRALE <i>Angle torque arm repair kit - Tipo/Type LEMFORDER</i>		93161958 93162239
3	730225	Piastra attacco barra angolare <i>Angle torque arm head assy - Tipo/Type LEMFORDER</i>		93161959
4	730227	Kit revisione barra angolare <i>Angle torque arm repair kit - Tipo/Type LEMFORDER</i>		93161960
5	712956	Barra di reazione angolare / <i>Angle torque arm - U.T.</i>	EUROTECH	504064007 41042092 41028599
6	730226	Kit revisione barra angolare - PARTE CENTRALE <i>Angle torque arm repair kit</i>	EUROTECH	93161958 93162239
7	730225	Piastra attacco barra angolare / <i>Angle torque arm head assy</i>	EUROTECH	93161959
8	730227	Kit revisione barra angolare / <i>Angle torque arm repair kit</i>	EUROTECH	93161960
9	712865	Barra di reazione angolare / <i>Angle torque arm</i>	EUROTECH "CURSOR" 190E31/E35/E39/E43 EUROSTAR "CURSOR" 190E39/E43 STRALIS	41042093 500340451
10	730227	Kit revisione barra angolare / <i>Angle torque arm repair kit</i>	EUROTECH	93161960
11	730226	Kit revisione barra angolare - PARTE CENTRALE <i>Angle torque arm repair kit</i>	EUROTECH	93161958 93162239
12	712858	Barra di reazione angolare / <i>Angle torque arm</i>	STRALIS	41218620 41218621
13	730219	Kit revisione barra angolare (41009665) - PARTE CENTRALE <i>Angle torque arm repair kit - Tipo/Type TRW</i>	EUROTECH - EUROSTAR	93161638
14	730218	Kit revisione barra angolare <i>Angle torque arm repair kit - Tipo/Type TRW</i>		93161637 93192361

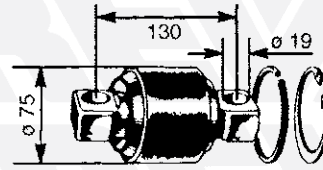
SOSPENSIONE PNEUMATICA / AIR SUSPENSION



L = mm 594

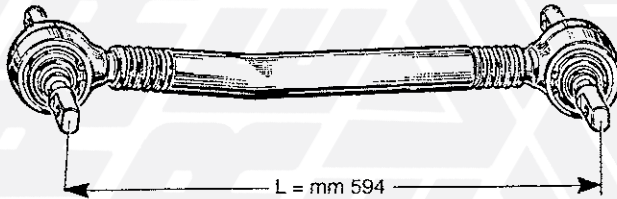
712951

1



730218

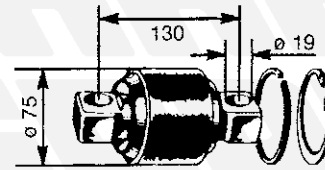
2



L = mm 594

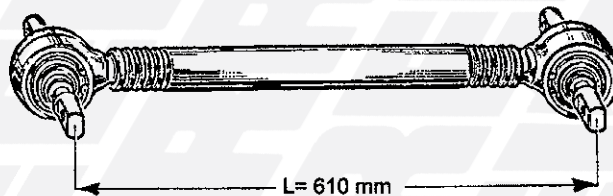
712955

3



730218

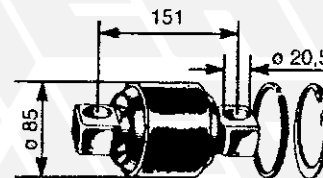
4



L = 610 mm

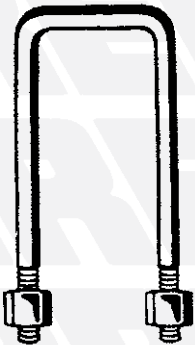
712949

5



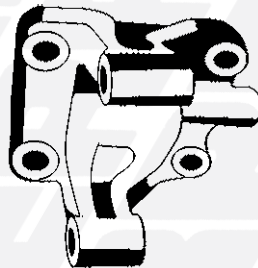
730201

6



7 - **722730** \varnothing 24x133,5x290

8 - **722731** \varnothing 24x133,5x355



724533

9



10 - **713403** fil. D. / RH thread M 8x1,25

11 - **713404** fil. S. / LH thread M 8x1,25

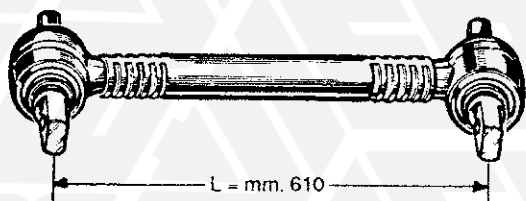


12 - **713420** fil. D. / RH thread M 8x1,25

13 - **713421** fil. S. / LH thread M 8x1,25

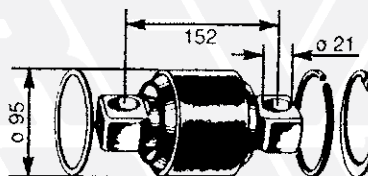
FIG. ITEM	RIF. ERREVI ERREVI REF.	DESCRIZIONE PARTICOLARI DESCRIPTION	TIPO VEHICLE MODEL	RIF. ORIG. ORIG. REF.	
EUROTECH - EUROTECH "CURSOR" EUROSTAR - EUROSTAR "CURSOR" STRALIS					
Segue: SOSPENSIONE PNEUMATICA Cont'd: AIR SUSPENSION					
1	712951	Barra di reazione completa / <i>Torque arm</i>	L = 594 mm.	41035951 41214462 41272429 98472466	
2	730218	Kit revisione barra di reazione / <i>Torque arm repair kit</i>		93161637 93192361	
3	712955	Barra di reazione completa / <i>Torque arm</i>	L = 594 mm.	500340452 41001626 41034330 41003268	
4	730218	Kit revisione barra di reazione / <i>Torque arm repair kit</i>		93192361 93161637	
5	712949	Barra di reazione / <i>Torque arm</i>	L = 610 mm.	EUROTECH EUROTECH "CURSOR" 260 E24/E31/E35/E43 EUROSTAR	41011008 42041107
6	730201	Kit revisione barra di reazione / <i>Torque arm repair kit</i>		EUROTECH EUROTECH "CURSOR" 260 E24/E31/E35/E43 EUROSTAR	93192618
7	722730	Staffa quadra c/dadi / <i>U bolt c/w nuts</i>	ø 24x133,5x290	41014745	
8	722731	Staffa quadra c/dadi / <i>U bolt c/w nuts</i>	ø 24x133,5x355	41014746	
9	724533	Supporto posteriore attacco barra reazione / <i>Bracket, rear</i>		EUROTECH - EUROSTAR	8164840
10	713403	Testina a snodo inf. filetto D. per asta valvola livellatrice <i>Ball joint (RH thread), bottom</i>	M8x1,25	EUROTECH - EUROSTAR	4525854 2997004 5006234802
11	713404	Testina a snodo inf. filetto S. per asta valvola livellatrice <i>Ball joint (LH thread), top</i>	M8x1,25	EUROTECH - EUROSTAR	4525855
12	713420	Testina a snodo sup. filetto D. per tirante <i>Ball joint (RH thread), top</i>	M8x1,25	EUROTECH	41019116
13	713421	Testina a snodo inf. filetto S. per tirante <i>Ball joint (LH thread), bottom</i>	M8x1,25	EUROTECH	41019115

SOSPENSIONE POSTERIORE / REAR SUSPENSION



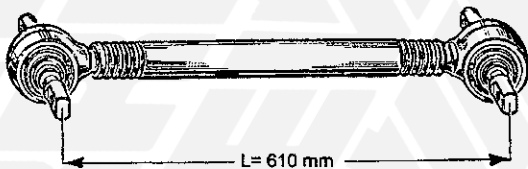
712649

1



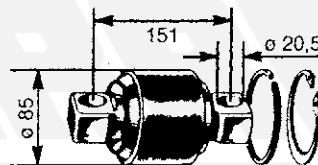
730202

2



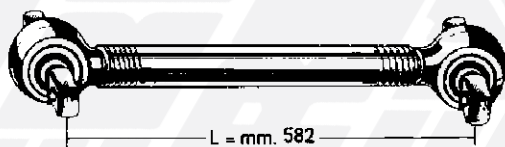
712949

3



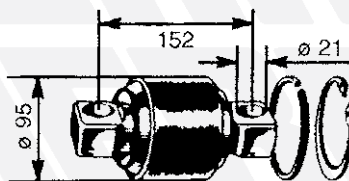
730201

4



712959

5



730202

6



726357

7



730223

8



730383

9



730302

21



- 10 - 721283 ø 16x185 T/Head 24 H. 13
- 11 - 721240 ø 16x210 T/Head 24 H. 13
- 12 - 721133 ø 16x270 T/Head 24 H. 13
- 13 - 721284 ø 16x300 T/Head 24 H. 13
- 14 - 721202 ø 16x310 T/Head 24 H. 13
- 15 - 721282 ø 16x315 T/Head 25 H. 11



729311

17



727059

19



730284

20



720219

22



729276

16



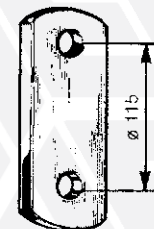
721084

23



729649

18



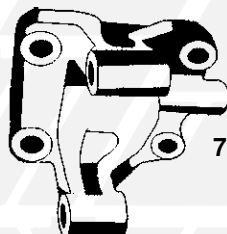
724733

24



730250

25



724533

26

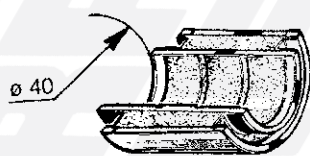


712999

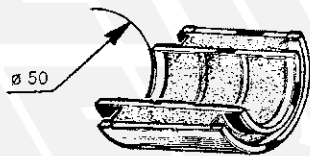
27

FIG. ITEM	RIF. ERREVI ERREVI REF.	DESCRIZIONE PARTICOLARI DESCRIPTION	TIPO VEHICLE MODEL	RIF. ORIG. ORIG. REF.
<p>EUROTRAKKER EUROTRAKKER "CURSOR" TRAKKER</p> <p>SOSPENSIONE POSTERIORE / REAR SUSPENSION</p>				
1	712649	Barra di reazione completa con teste fisse / <i>Rigid torque arm</i>	330E34/E37 - 380E34/E37/E42 410E37/E42 - 720E37/E42	41011006 42065332
2	730202	Kit revisione testa barra / <i>Torque arm repair kit</i>	330E34/E37 - 380E34/E37/E42 410E37/E42 - 720E37/E42	93192619 42493431
3	712949	Barra di reazione / <i>Torque arm</i>	L= 610 mm EUROTRAKKER EUROTRAKKER "CURSOR"	41011008 42041107
4	730201	Kit revisione testa barra / <i>Torque arm repair kit</i>	EUROTRAKKER EUROTRAKKER "CURSOR"	93192618
5	712959	Barra di reazione / <i>Torque arm</i>	L= 582	5801384823 41218021
6	730202	Kit revisione barra / <i>Torque arm repair kit</i>		93192619 42493431
7	726357	Anello rasamento occhio balestra e piastra biscottino <i>Thrust ring spring eye and shackle plate</i>	ø 37x88x3,5	8138938
8	730223	Boccola elastica perno bal. e supporto bal. (lato POST.) <i>Silentblock</i>	ø 20,4x62,3x106 180E25-190E30/E31/E34/E37/E42 400E31/E34/E37/E42	8160687
9	730383	Boccola elastica barra stabilizzatrice / <i>Silentblock, stabilizer bar</i>	ø 28x60x44/50 EUROTRAKKER	41218902 41288750 500336108
10	721283	Bullone centrale bal. PARABOLICA c/dado / <i>Centre bolt c/w nut</i>	ø 16x185 T/H 24x13	2467128
11	721240	Bullone centrale c/dado / <i>Centre bolt c/w nut</i>	ø 16x210 T/H 24x13	2513415
12	721133	Bullone centrale c/dado / <i>Centre bolt c/w nut</i>	ø 16x270 T/H 24x13	42017892
13	721284	Bullone centrale c/dado / <i>Centre bolt c/w nut</i>	ø 16x300 T/H 24x13	-
14	721202	Bullone centrale c/dado / <i>Centre bolt c/w nut</i>	ø 16x310 T/H 24x13	-
15	721282	Bullone centrale c/dado / <i>Centre bolt c/w nut</i>	ø 16x315 T/H 25x11	42122596
16	729276	Dado perno balestra / <i>Spring pin nut</i>	M20x1,5 H.22 CH.30	8161193
17	729311	Dado staffa / <i>U bolt nut</i>	M24x2 H.36 - CH.36	-
18	729649	Dado c/collarino bloccaggio perno silentblock barra stabilizzatrice <i>Flanged nut</i>	M 20x2,5	16750725 16750721
19	727059	Distanziale occhio balestra (Lato POST.) <i>Spring eye spacer, rear end</i>	ø 20,5x37x107	8138900
20	730284	Paracolpi per foglie balestra / <i>Spring buffer</i>		41006350
21	730302	Paracolpi in gomma per balestra / <i>Rubber buffer</i>	EUROTRAKKER	4715638
22	720219	Perno balestra e piastra biscottino / <i>Spring pin</i>	M20x1,5 L=155	8161192
23	721084	Perno bloccaggio silentblock barra stabilizzatrice / <i>Bolt</i>	ø 28x62	42120135
24	724733	Piastra biscottino (interasse mm.115) / <i>Shackle plate</i>		8134539
25	730250	Silentblock barra stabilizzatrice / <i>Silentblock, stabilizer bar</i>	ø 28x62,2x50	8162306
26	724533	Supporto posteriore attacco barra reazione / <i>Bracket, rear</i>		8164840
27	712999	Tirante per barra stabilizzatrice posteriore / <i>Thrust rod, rear</i>		41007812

SOSPENSIONE POSTERIORE / REAR SUSPENSION



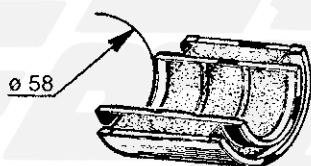
730268
1



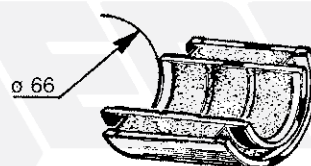
730314
2



730280
3



730271
4



730288
5



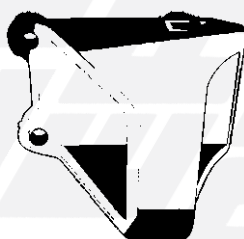
6 - 722216 \varnothing 20x100x520



7 - 722214 \varnothing 24x100x330
8 - 722215 \varnothing 24x100x360
9 - 722734 \varnothing 24x100x380



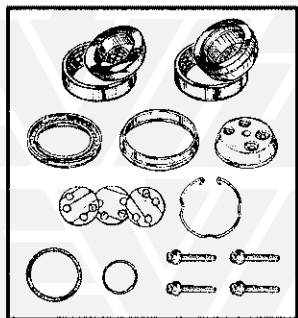
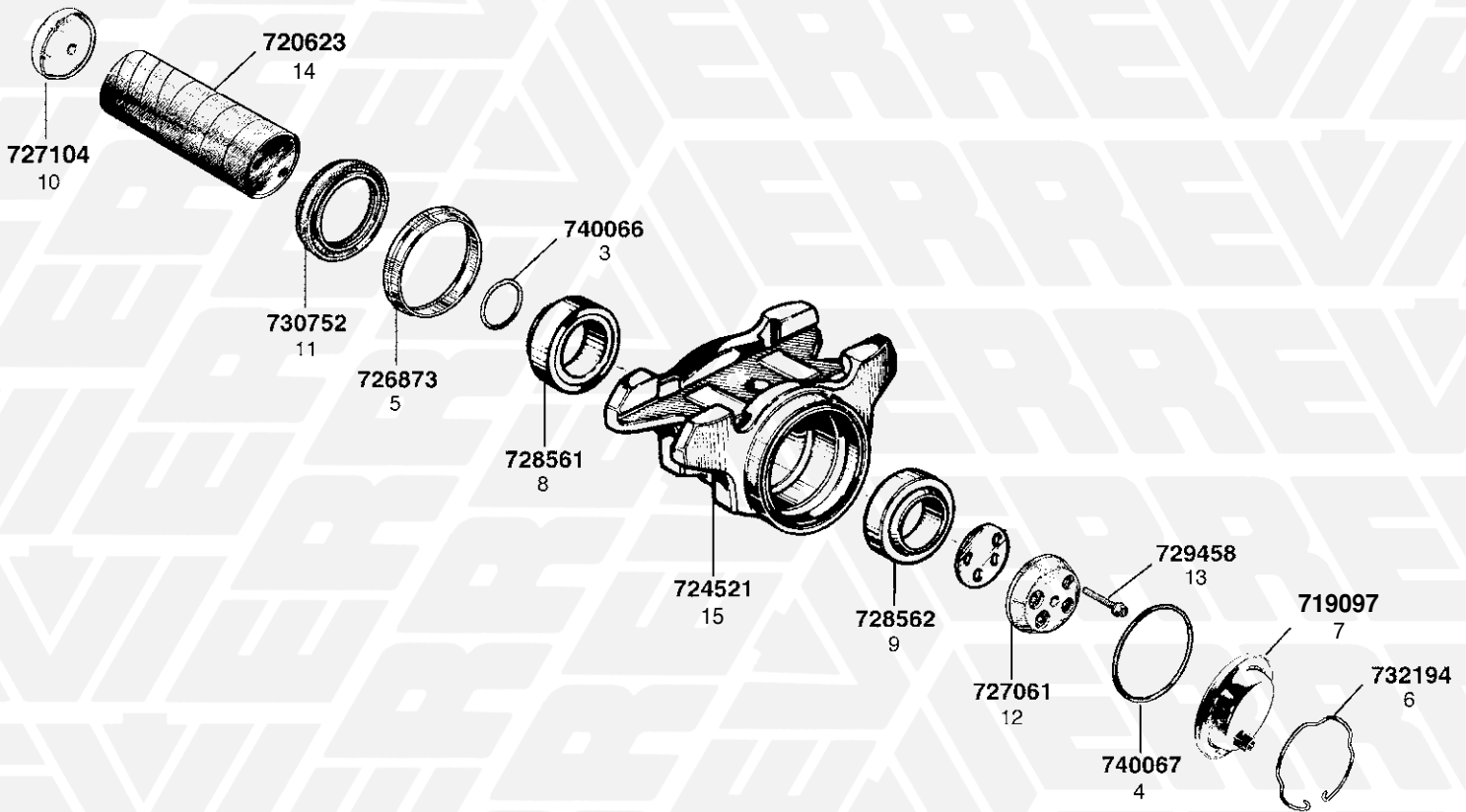
10 - 722200 \varnothing 24x100x410
11 - 722201 \varnothing 24x100x430
12 - 722202 \varnothing 24x100x460
13 - 722188 \varnothing 24x100x485
14 - 722189 \varnothing 24x100x510
15 - 722190 \varnothing 24x100x535



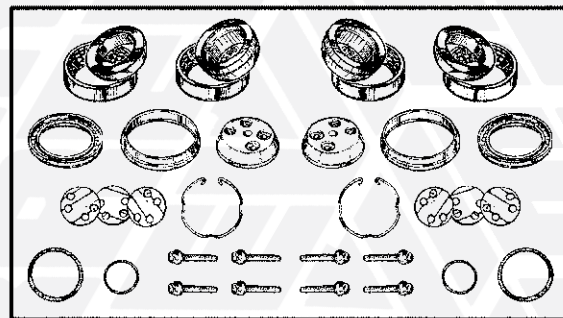
724531
16

FIG. ITEM	RIF. ERREVI ERREVI REF.	DESCRIZIONE PARTICOLARI DESCRIPTION	TIPO VEHICLE MODEL	RIF. ORIG. ORIG. REF.
EUROTRAKKER EUROTRAKKER "CURSOR" TRAKKER				
SOSPENSIONE POSTERIORE / REAR SUSPENSION				
1	730268	Semiboccola per barra stabilizzatrice / <i>Stabilizer bar half-bushing</i>	ø int. 40	2520448
2	730314	Semiboccola per barra stabilizzatrice / <i>Stabilizer bar half-bushing</i>	ø int. 50	2521850
3	730280	Semiboccola per barra stabilizzatrice / <i>Stabilizer bar half-bushing</i>	ø int. 55	2521481
4	730271	Semiboccola per barra stabilizzatrice / <i>Stabilizer bar half-bushing</i>	ø int. 58	260E31 - 340E35 41270883 8169892
5	730288	Semiboccola barra stabilizzatrice / <i>Stabilizer bar half-bushing</i>	ø int. 66	EUROTRAKKER "CURSOR" TRAKKER 41015581
6	722216	Staffa balestra QUADRA c/dadi / <i>U bolt c/w nuts</i>	ø 20x100x520	8138270
7	722214	Staffa semitonda piatta c/dadi / <i>U bolt c/w nuts</i>	ø 24x100x330	42079550
8	722215	Staffa semitonda piatta c/dadi / <i>U bolt c/w nuts</i>	ø 24x100x360	42074994
9	722734	Staffa semitonda piatta c/dadi / <i>U bolt c/w nuts</i>	ø 24x100x380	42065777
10	722200	Staffa semitonda piatta c/dadi / <i>U bolt c/w nuts</i>	ø 24x100x410	42052121
11	722201	Staffa semitonda piatta c/dadi / <i>U bolt c/w nuts</i>	ø 24x100x430	-
12	722202	Staffa semitonda piatta c/dadi / <i>U bolt c/w nuts</i>	ø 24x100x460	-
13	722188	Staffa semitonda piatta c/dadi / <i>U bolt c/w nuts</i>	ø 24x100x485	42065780
14	722189	Staffa semitonda piatta c/dadi / <i>U bolt c/w nuts</i>	ø 24x100x510	-
15	722190	Staffa semitonda piatta c/dadi / <i>U bolt c/w nuts</i>	ø 24x100x535	42050261
16	724531	Supporto guida balestra posteriore / <i>Spring bracket, rear</i>		8160830 8164042

BILANCIERE / EQUALIZER ASSY



711709
1



711710
2

FIG. ITEM	RIF. ERREVI ERREVI REF.	DESCRIZIONE PARTICOLARI DESCRIPTION	TIPO VEHICLE MODEL	RIF. ORIG. ORIG. REF.
<p>EUROTRAKKER 330E34/E37 - 340E34 - 380E31/E34/E37/E42/E47 410E37/E42 - 720E31/E37/E42/E47</p> <p>EUROTRAKKER "CURSOR" 380E35/E38/E44/E48 - 410E35/E38/E44/E48 720E38/E44/E48</p> <p>TRAKKER 380T35/T36/T38/T41/T42/T44/T45/T48/T50 410 720T38/T41/T42/T44/T45/T50</p> <p>BILANCIERE / EQUALIZER ASSY</p>				
1	711709	Serie completa revisione bilanciere (1 SOLA PARTE) Equalizer repair kit (single)		-
2	711710	Serie completa revisione bilanciere (2 PARTI) Equalizer repair kit (double)		-
3	740066	Anello di tenuta interno / Inner seal		17298081
4	740067	Anello di tenuta esterno / Outer seal		17299681
5	726873	Anello di tenuta interno IN LAMIERA / Fabricatel inner seal		41025132 8138626
6	732194	Anello a molla / Snap ring		41016555 8138614
7	719097	Calotta di protezione Trunnion cap		2997054 8138327
8	728561	Cuscinetto interno / Inner bearing	ø 122x180x62	8138307
9	728562	Cuscinetto esterno / Outer bearing	ø 120x180x38	8138308
10	727104	Flangia fissaggio perno Spacer		41015808
11	730752	Paraolio interno per albero supporto bilanciere Inner oil seal		40101540
12	727061	Rondella esterna supporto centrale bilanciere Thrust washer		41016627 8138276
13	729458	Vite FLANGIATA autobloccante Self locking bolt	M16x2 L= 70 mm.	1172083
14	720623	Perno centrale bilanciere Rocker-beam pin	ø 120x122x394	8138275
15	724521	Supporto centrale bilanciere / Trunnion		8138566

SOSPENSIONE ANTERIORE / FRONT SUSPENSION



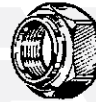
712654

1



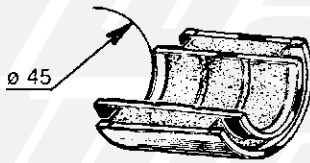
729424

2



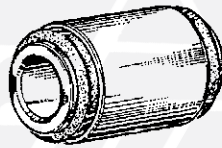
729425

3



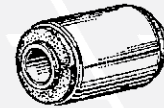
730156

4



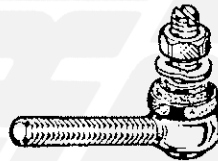
5 - 730157 $\varnothing 82/62/40 \times 90$

6 - 730159 $\varnothing 82/52,5/40 \times 90$



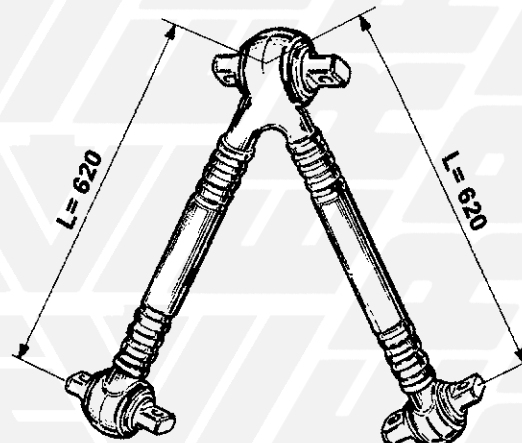
730251 $\varnothing 24 \times 55 \times 65$

7



8 - 713403 fil. D. / RH thread M 8x1,25

9 - 713404 fil. S. / LH thread M 8x1,25



712957

10

FIG. ITEM	RIF. ERREVI ERREVI REF.	DESCRIZIONE PARTICOLARI DESCRIPTION	TIPO VEHICLE MODEL	RIF. ORIG. ORIG. REF.
<h2>IVECO AUTOBUS</h2> <h3>370 (TUTTI I TIPI / ALL MODELS)</h3> <h4>SOSPENSIONE ANTERIORE / FRONT SUSPENSION</h4>				
1	712654	Barra di reazione completa / <i>Torque arm</i>		4738069
2	729424	Dado per perno barra di reazione inferiore <i>Nut, torque arm pin, bottom</i>	M 30x1,5 CH.46	4738064
3	729425	Dado per perno barra di reazione superiore e trasversale <i>Nut, torque arm pin, top</i>	M 40x1,5 CH.59	4677663
4	730156	Semiboccola per barra stabilizzatrice <i>Stabilizer bar half-bushing</i>	ø int. 45	370S24/S25L/S27 370S29/S30/S35 41823414
5	730157	Silentblock per barra di reazione / <i>Silentblock</i>	ø 40x62/82x90	500343454 4703856
6	730159	Silentblock per barra di reazione / <i>Silentblock</i>	ø 40x52,5/82x90	4746348
7	730251	Silentblock per barra di reazione / <i>Silentblock</i>	ø 24x55x65	370S24/S25L/S30/S35 370SE27/SE29/SE35 500343453 4639392
8	713403	Testina a snodo inf. filetto D. / <i>Ball joint (RH thread), bottom</i>	M8x1,25	4525854 2997004 5006234802
9	713404	Testina a snodo sup. filetto S. / <i>Ball joint (LH thread), top</i>	M8x1,25	4525855
10	712957	Barra di reazione angolare <i>Angle torque arm</i>	CITYCLASS	99484068 99432563

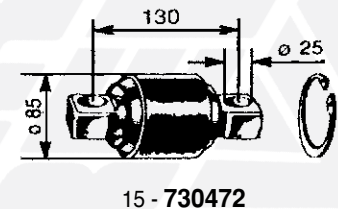
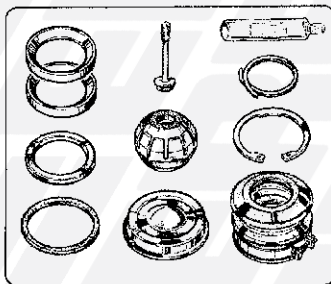
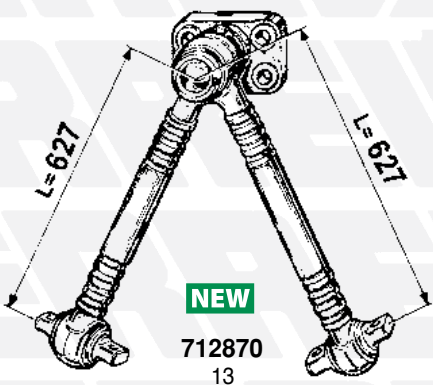
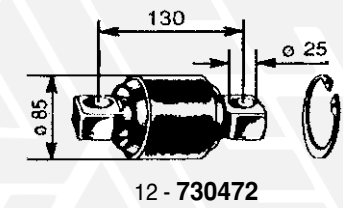
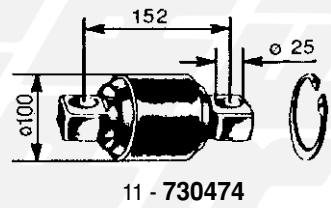
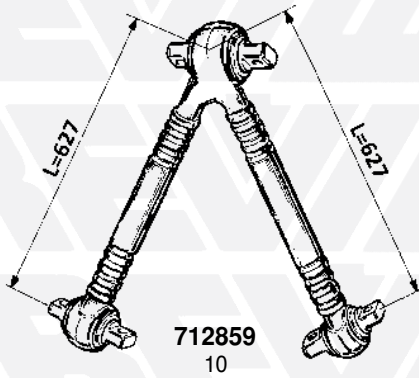
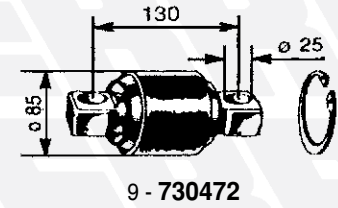
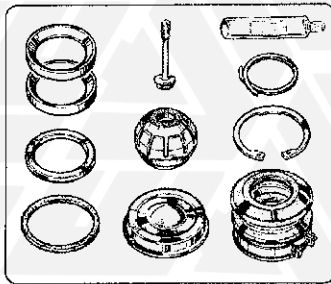
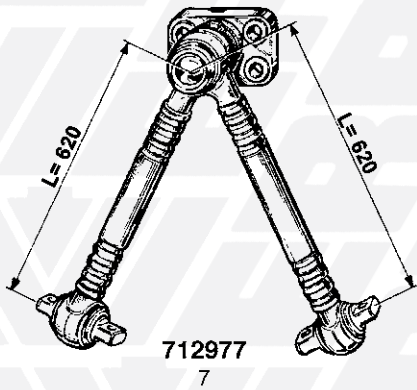
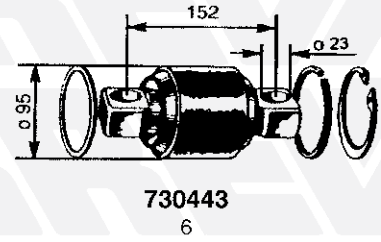
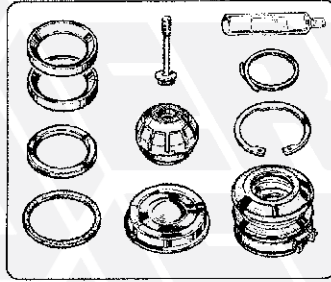
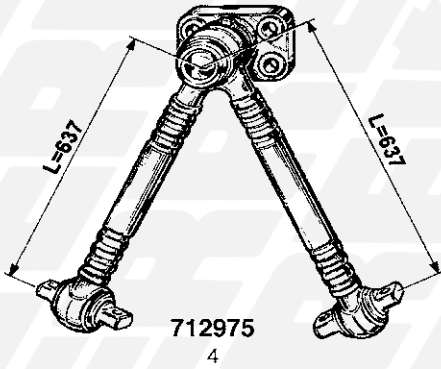
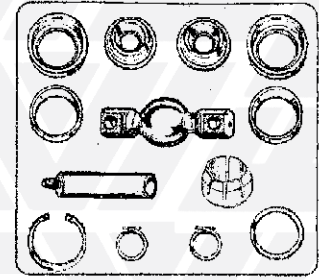
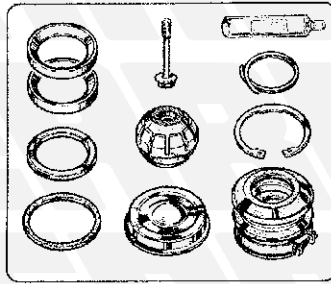
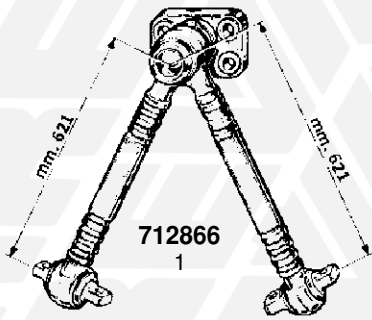
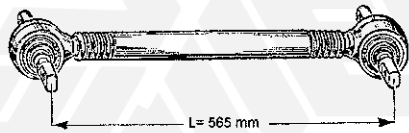
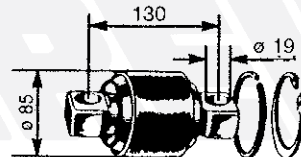


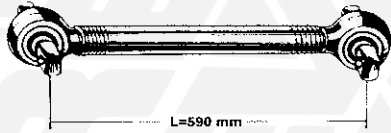
FIG. ITEM	RIF. ERREVI ERREVI REF.	DESCRIZIONE PARTICOLARI DESCRIPTION	TIPO VEHICLE MODEL	RIF. ORIG. ORIG. REF.
<h1>MAN</h1> <h2>SOSPENSIONI / SUSPENSIONS</h2>				
1	712866	Barra di reazione angolare <i>Angle torque arm</i>	F90 - F2000 - TGA	81432706034 81432706054 81432706074 81432706076 81432706078 81432706082
2	730240	Kit revisione barra angolare - PARTE CENTRALE - <i>Angle torque arm repair kit</i>	F90 - F2000	81953016132
3	730241	Kit revisione barra angolare <i>Angle torque arm repair kit</i>	F90 - F2000	81953016133
4	712975	Barra di reazione angolare <i>Angle torque arm</i>	F90 - F2000	81432706056 81432706075 81432706077 81432706081 81432709056
5	730240	Kit revisione barra angolare - PARTE CENTRALE - <i>Angle torque arm repair kit</i>	F90 - F2000	81953016132
6	730443	Kit revisione barra di reazione <i>Torque arm repair kit</i>	F90 - F2000	81432706079
7	712977	Barra di reazione angolare <i>Angle torque arm</i>	TGA	81432706096 81432706121 81432706114 81432706221
8	730240	Kit revisione barra angolare - PARTE CENTRALE - <i>Angle torque arm repair kit</i>	TGA	81953016132
9	730472	Kit revisione barra di reazione / <i>Torque arm repair kit</i>	F2000 - TGA - TGS - TGX	81432706105
10	712859	Barra di reazione angolare <i>Angle torque arm</i>	E2000 - F2000 TGA - TGS - TGM - TGX	81432706087 81432706088 81432706094 81432706095 81432706137 81432706150 81432706116
11	730474	Kit revisione barra di reazione (PARTE CENTRALE) <i>Torque arm repair kit</i>	F2000 TGA - TGM - TGS - TGX	81432706110
12	730472	Kit revisione barra di reazione / <i>Torque arm repair kit</i>	F2000 - TGA - TGS - TGX	81432706105
13	712870	Barra di reazione angolare <i>Angle torque arm</i>	TGA - TGS - TGX	81432706117 81432706152 81432706164
14	730240	Kit revisione barra angolare - PARTE CENTRALE - <i>Angle torque arm repair kit</i>	TGA - TGS - TGX	81953016132
15	730472	Kit revisione barra di reazione / <i>Torque arm repair kit</i>	F2000 - TGA - TGS - TGX	81432706105



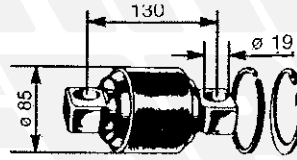
712990
1



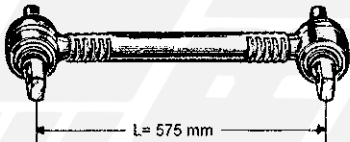
730186
2



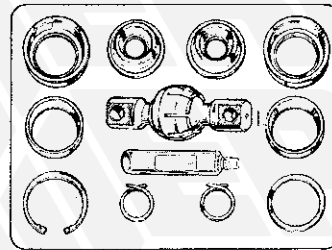
712976
3



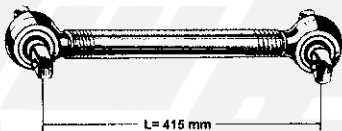
730186
4



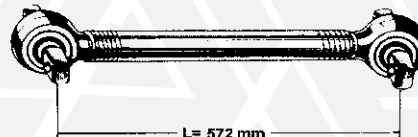
712991
5



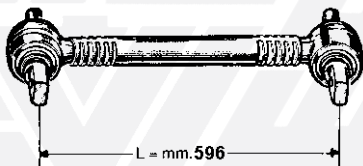
730191
6



712979
7

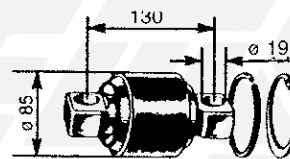


712978
8



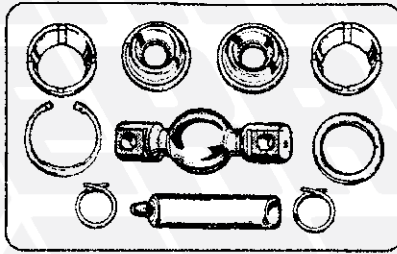
712873
9

NEW



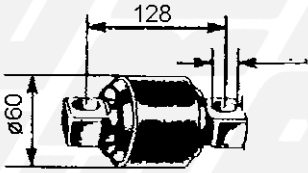
730186
10

FIG. ITEM	RIF. ERREVI ERREVI REF.	DESCRIZIONE PARTICOLARI DESCRIPTION		TIPO VEHICLE MODEL	RIF. ORIG. ORIG. REF.
SOSPENSIONI / SUSPENSIONS					
1	712990	Barra di reazione / <i>Torque arm</i>	L= 565	F90 - F2000	81432206052 81432206010 81432206012 81432206013 81432206018
2	730186	Kit revisione barra di reazione / <i>Torque arm repair kit</i>		F90 - F2000	81432206055 81432206250
3	712976	Barra di reazione <i>Torque arm</i>	L= 590	F90 - F2000	81432206067 81432206068 81432206090 81432206092 81432209092
4	730186	Kit revisione barra di reazione / <i>Torque arm repair kit</i>		F90 - F2000	81432206055 81432206250
5	712991	Barra di reazione / <i>Torque arm</i>	L= 575	F2000 - M2000 - F90 - M90 - TGA	81432206096 81432206098 81432206129 81432306014 81432306030
6	730191	Kit revisione barra di reazione - con perno - <i>Angle torque arm repair kit c/w pin</i>		F2000 - M2000 - F90 - M90 - TGA	81432206108
7	712979	Barra di reazione / <i>Torque arm</i>	L= 415	TGA	81432206247
8	712978	Barra di reazione <i>Torque arm</i>	L= 572	TGA	81432206236 81432206272 81432206267 81432206229
9	712873	Barra di reazione <i>Torque arm</i>	L= 596 mm	E2000 - F2000 TGA - TGS - TGX	81432206196 81432206232 81432206233
10	730186	Kit revisione barra di reazione <i>Torque arm repair kit</i>		TGA - TGS - TGX	81432206055 81432206250



730244

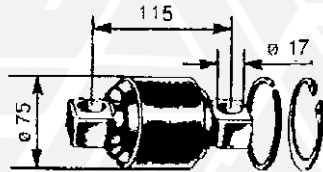
1



730886

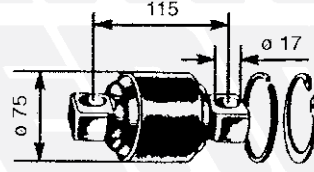
2

NEW



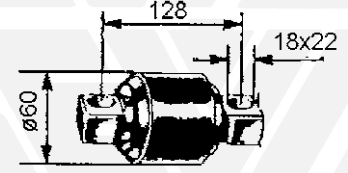
730916

3



730242

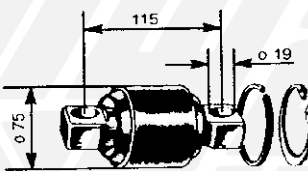
4



730881

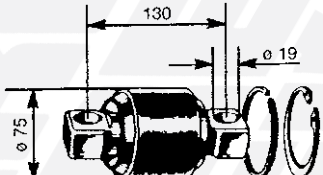
5

NEW



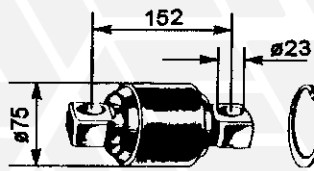
730419

6



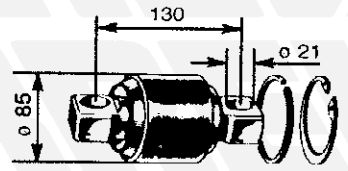
730218

7



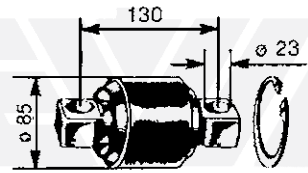
730450

8



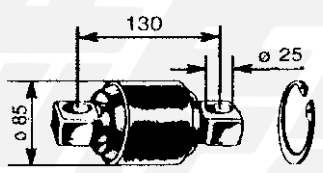
730442

9



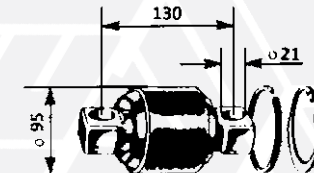
730985

10



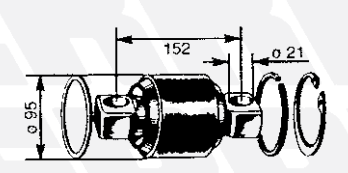
730473

11



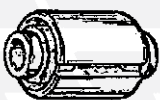
730972

12



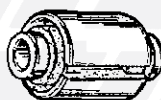
730202

13



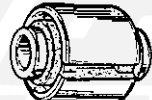
730366

14



730467

15



730990

16



730882

17

NEW



730887

18

NEW



730896

19

NEW



730959

20



730885

21

NEW



730466

22



730599

23

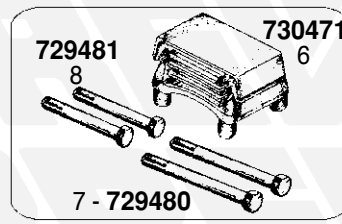
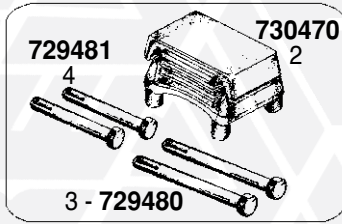


730600

24

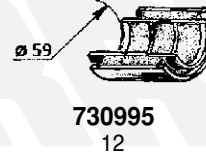
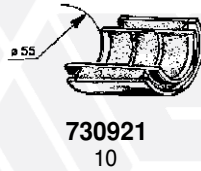
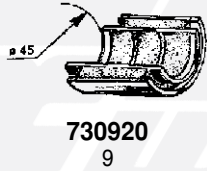
FIG. ITEM	RIF. ERREVI ERREVI REF.	DESCRIZIONE PARTICOLARI DESCRIPTION		TIPO VEHICLE MODEL	RIF. ORIG. ORIG. REF.
SOSPENSIONI / SUSPENSIONS					
1	730244	Kit revisione barra / <i>Torque arm repair kit</i>		F90 - M90	81432306043
2	730886	Perno gommato barra stab. post. / <i>Stabilizer bar rubber pin, rear</i>	ø 68,5	TGA - TGS	81437220072
3	730916	Kit revisione barra di reazione <i>Torque arm repair kit</i>		F90 - M90 - E2000 - F2000 M2000	81432706064 81432306051 81432306072
4	730242	Kit revisione barra / <i>Torque arm repair kit</i>		TGA	81432206244
5	730881	Perno gommato balestra / <i>Spring pin</i>		TGS - TGX - TGA	81432400157
6	730419	Kit revisione barra di reazione / <i>Torque arm repair kit</i>		TGM	81432706119
7	730218	Kit revisione barra / <i>Angle torque arm repair kit</i>			81432303031 81432306061
8	730450	Kit revisione barra di reazione / <i>Torque arm repair kit</i>			81432706100
9	730442	Kit revisione barra di reazione / <i>Torque arm repair kit</i>			81432206203
10	730985	Kit revisione barra di reazione / <i>Torque arm repair kit</i>		F2000 - TGA - TGS - TGX	81432706126
11	730473	Kit revisione barra di reazione / <i>Torque arm repair kit</i>		TGA - TGS - TGX	81432206285
12	730972	Kit revisione barra di reazione / <i>Torque arm repair kit</i>		E2000 - F2000 - F90 - TGA	81432206241
13	730202	Kit revisione barra angolare / <i>Angle torque arm repair kit</i>		BUS SG220-SG240H-SG242-242H	81432706040
14	730366	Boccola elastica per barra stabilizzatrice <i>Silentblock, stabilizer bar</i>	ø 16x47,5x47	F2000 - L2000 - M2000 F90 - G90	81437220038 81962100450 81962100469
15	730467	Boccola elastica fissaggio barra stabilizzatrice anteriore <i>Silentblock, front stabilizer bar</i>	ø 16x50x47	F90 - M2000 - L2000 TGA - TGS - TGX	81437220059
16	730990	Boccola elastica barra stabilizzatrice post. <i>Stabilizer bar rubber bush, rear</i>	ø 22x68x62	F2000 - M2000	81437220039 81437220063 81437220082
17	730882	Boccola elastica barra stabilizzatrice / <i>Rubber bush</i>	ø 22x75x62	F90 - F2000 - TGA	81437220019 81437226051
18	730887	Boccola elastica barra stab. post. / <i>Stabilizer bar rubber bush, rear</i>	ø 53,5x81x70	F2000 - M2000 - E2000 - F90 M90 - TGA - TGM - TGS - TGX	81437220040 81437220041 81437220042
19	730896	Boccola elastica balestra / <i>Silentblock</i>	ø 24x62x100	F2000 - TGA - TGS - TGX	81437220087 81962100634
20	730959	Boccola elastica balestra anteriore / <i>Silentblock, front</i>	ø 24,5x62x95	TGA - TGS - TGX	81437220091
21	730885	Boccola elastica occhio balestra anteriore <i>Spring eye rubber bush, front</i>	ø 24x65x95	TGA - TGS - TGX	81437220070 81962100616
22	730466	Boccola balestra ant. / post. <i>Spring bush</i>	ø 16x50x95	G90 - L2000 - M2000	81960200231 81960200250 81960200251
23	730599	Boccola balestra posteriore / <i>Spring bush</i>	ø 24x70,5x88/95	F2000	81437220061
24	730600	Boccola balestra posteriore / <i>Spring bush</i>	ø 24x70,5x88/105	F2000	81437220062 81437220045

1 SOSPENSIONI / SUSPENSIONS

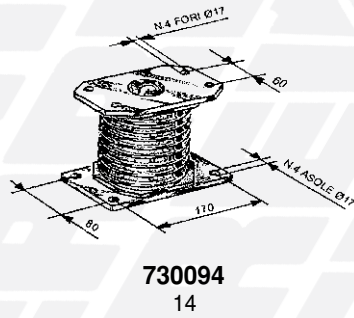


711053
1

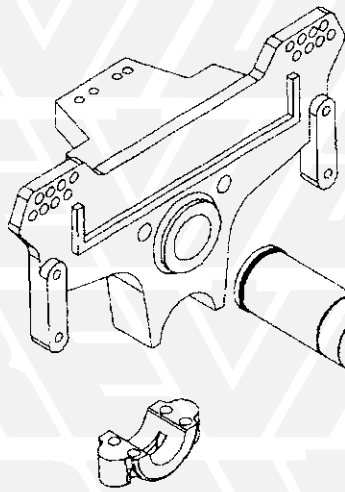
711054
5



NEW



2 BILANCIERE / EQUALIZER ASSY



720624
20

728565
19

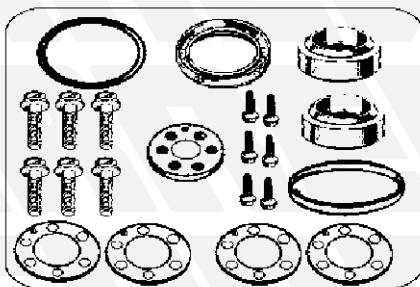
728565
19

729482
23

724536
22

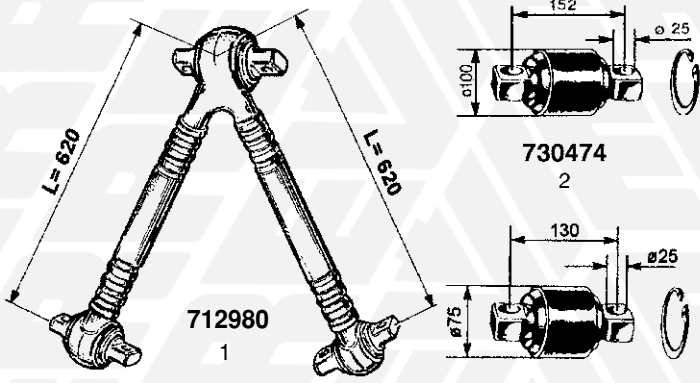
726378
21

724543
18



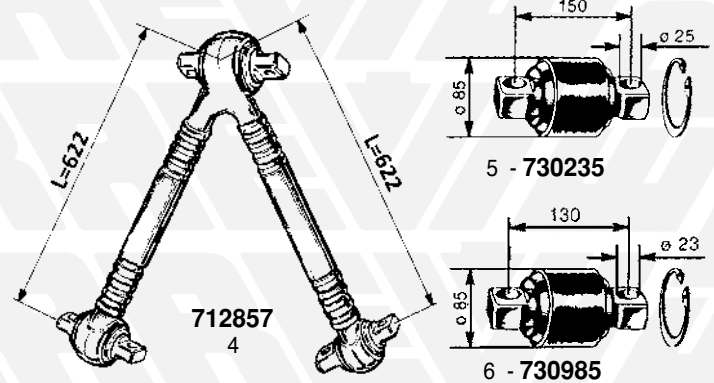
711215
17

FIG. ITEM	RIF. ERREVI ERREVI REF.	DESCRIZIONE PARTICOLARI DESCRIPTION	TIPO VEHICLE MODEL	RIF. ORIG. ORIG. REF.
1 SOSPENSIONI / SUSPENSIONS				
1	711053	Complessivo per paracolpo balestra (lato destro) <i>Rubber buffer complete kit (right side)</i> Composto da: / Complete with:	F2000 - TGA - TGS - TGX - TGM	819621005475 819621005545
2	730470	(1) Paracolpo balestra / <i>Rubber buffer</i>		81962100547 81962100554
3	729480	(2) Bullone paracolpo bal. / <i>Rubber buffer bolt</i>	M20x2 L= 260	06014944935
4	729481	(2) Bullone paracolpo bal. / <i>Rubber buffer bolt</i>	M20x2 L= 240	06014944933
5	711054	Complessivo per paracolpo balestra (lato sinistro) <i>Rubber buffer complete kit (left side)</i> Composto da: / Complete with:	F2000 - TGA - TGS - TGX - TGM	819621005485 819621005555
6	730471	(1) Paracolpo balestra / <i>Rubber buffer</i>		81962100548 81962100555
7	729480	(2) Bullone paracolpo bal. / <i>Rubber buffer bolt</i>	M20x2 L= 260	06014944935
8	729481	(2) Bullone paracolpo bal. / <i>Rubber buffer bolt</i>	M20x2 L= 240	06014944933
9	730920	Semiboccola barra stabilizz. ANTERIORE / <i>Stabilizer bar, half-bushing</i>	ø int. / inn. 45 F90	81437040057
10	730921	Semiboccola barra stabilizz. POSTERIORE / <i>Stabilizer bar, half-bushing</i>	ø int. / inn. 55 F90	81437040060
11	730969	Tassello appoggio balestra / <i>Rubber buffer</i>	E2000 - F2000 - M2000 - F90 TGA - TGM - TGS - TGX	81962100379
12	730995	Semiboccola barra stabilizzatrice posteriore <i>Stabilizer bar half-bushing, rear</i>	ø int. 59 L= 60 F90 - F2000	81437040061 81437220020
13	730883	Tampone paracolpo balestra post. / <i>Rubber buffer</i>	81x121x19 TGS - TGM - TGA	81434070112
14	730094	Tassello elastico per balestra / <i>Spring core</i>	F90 - F2000	81962105021 81962105022 81962105023
15	730981	Tassello elastico balestra posteriore / <i>Spring core, rear</i>	TGA	81962100550
16	730982	Tassello elastico balestra posteriore / <i>Spring core, rear</i>	E2000 - F2000	81962105025 81962105026 81962105027
2 BILANCIERE / EQUALIZER ASSY				
17	711215	Serie completa revisione bilanciante (1 sola PARTE) <i>Equalizer repair kit (SINGLE)</i>	F90 - F2000 - TGA	814135000185
18	724543	Coperchio per supporto centrale bilanciante / <i>Trunnion cover</i>	F90 - F2000 - TGA	81413520009
19	728565	Cuscinetto interno/esterno / <i>Bearing</i>	F90 - F2000 - TGA	06369590027 06369590030
20	720624	Perno centrale bilanciante / <i>Rocker beam pin</i>	ø 96x318 F90 - F2000 - TGA	81354010089
21	726378	Rondella esterna supporto centrale bilanciante / <i>Lock washer</i>	F90 - F2000 - TGA	81413020021
22	724536	Supporto centrale bilanciante / <i>Trunnion</i>	F90 - F2000 - TGA	81413500018
23	729482	Vite flangiata / <i>Flange screw</i>	M14x1,5 L=50 F90 - F2000 - TGA	06028158915 06028142915 06028134915



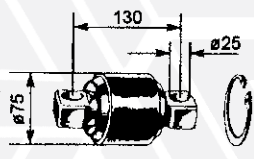
712980
1

730474
2

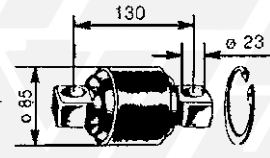


712857
4

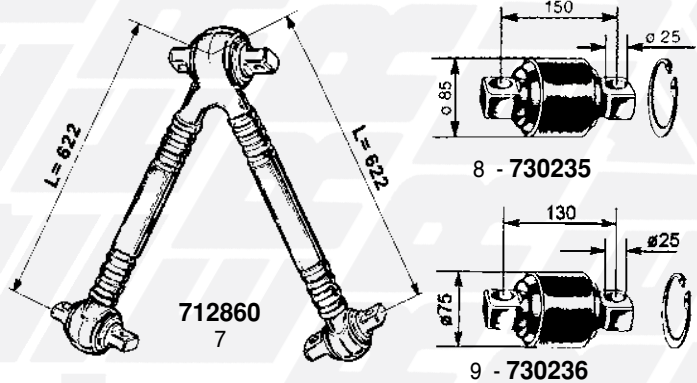
5 - 730235



730236
3

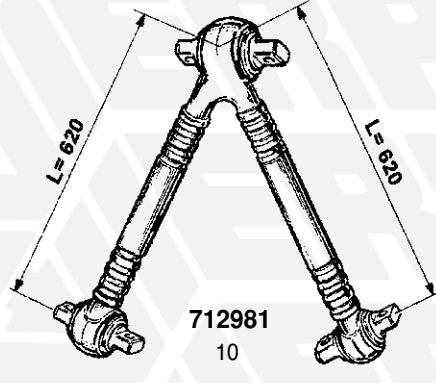


6 - 730985

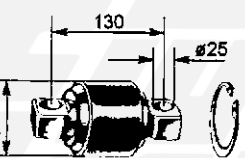


712860
7

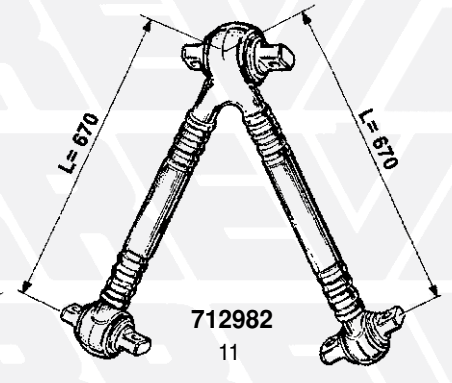
8 - 730235



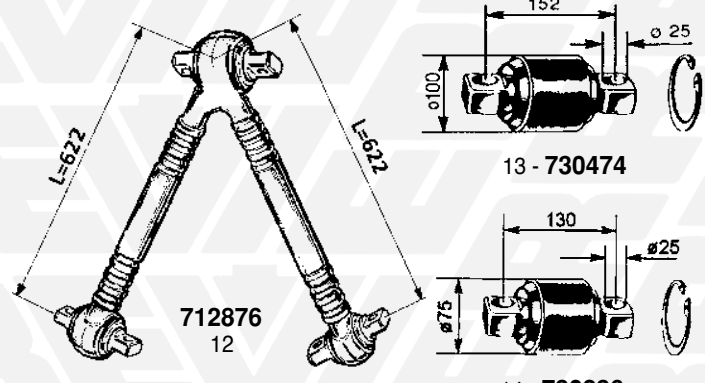
712981
10



9 - 730236

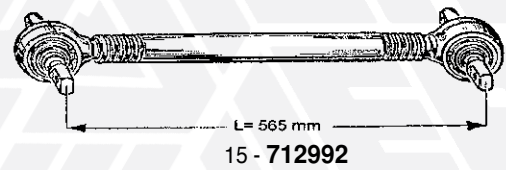


712982
11

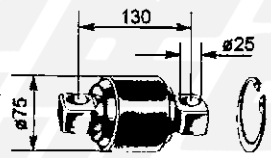


712876
12

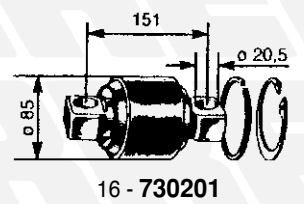
13 - 730474



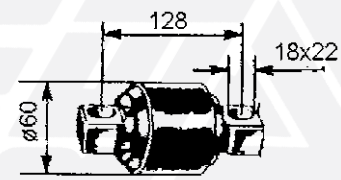
15 - 712992



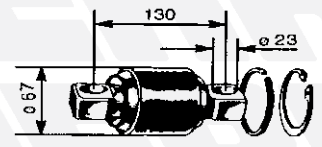
14 - 730236



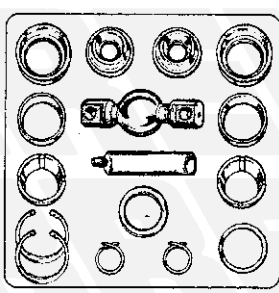
16 - 730201



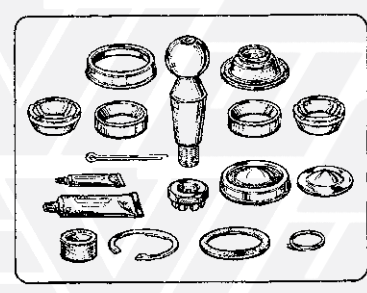
19 - 730881



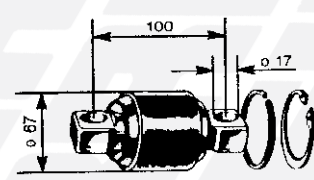
21 - 730245



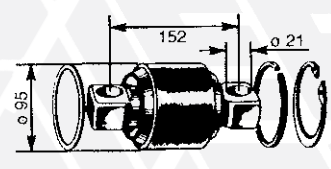
730200
17



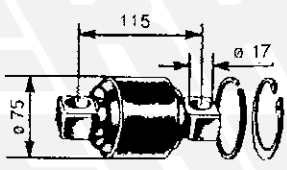
730230
18



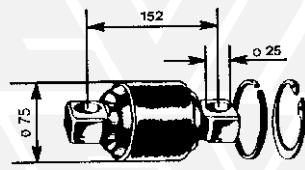
20 - 730490



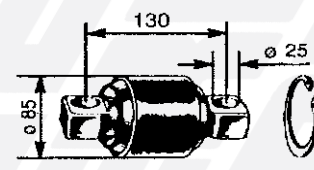
25 - 730202



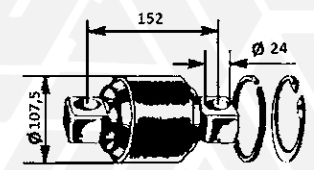
22 - 730916



23 - 730488

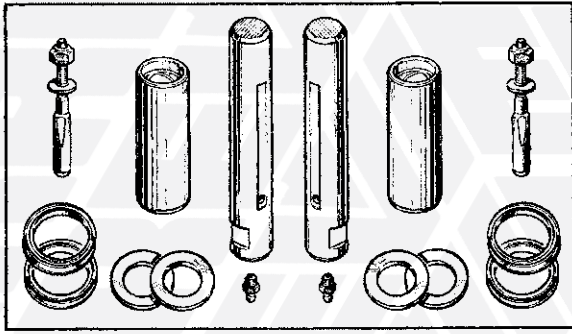


24 - 730472

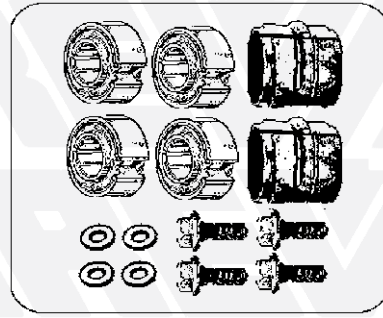


26 - 730984

FIG. ITEM	RIF. ERREVI ERREVI REF.	DESCRIZIONE PARTICOLARI DESCRIPTION	TIPO VEHICLE MODEL	RIF. ORIG. ORIG. REF.
MERCEDES				
SOSPENSIONI / SUSPENSIONS				
1	712980	Barra di reazione angolare <i>Angle torque arm</i>	ATEGO - AXOR - ACTROS	9443500305 9473500905 9483500405 9483501105 9483503005
2	730474	Kit revisione barra di reazione - PARTE CENTRALE <i>Torque arm repair kit</i>	AXOR - AXOR 2 ACTROS - ACTROS MP2	0003504905
3	730236	Kit revisione barra angolare - PARTE LATERALE <i>Angle torque arm repair kit</i>	ATEGO - AXOR - ACTROS	0003502505 0003502205 0003504105
4	712857	Barra di reazione angolare <i>Angle torque arm</i>	AXOR - AXOR 2 - ACTROS ACTROS MP2 - ACTROS MP4	9423500505 9423500805 9423501205
5	730235	Kit revisione barra angolare - PARTE CENTRALE <i>Angle torque arm repair kit</i>		0003502305 0003504405
6	730985	Kit revisione barra di reazione <i>Torque arm repair kit</i>	AXOR - AXOR 2 - ACTROS ACTROS MP2 - ACTROS MP4	0003503305 0003504805
7	712860	Barra di reazione angolare <i>Angle torque arm</i>	ACTROS - ACTROS MP2 ACTROS MP4 - AXOR ATEGO - ATEGO 2	9423501005 9423501505 9443500005 9473501005
8	730235	Kit revisione barra angolare - PARTE CENTRALE <i>Angle torque arm repair kit</i>		0003502305 0003504405
9	730236	Kit revisione barra angolare - PARTE LATERALE <i>Angle torque arm repair kit</i>		0003502505 0003502205 0003504105
10	712981	Barra di reazione angolare <i>Angle torque arm</i>	ACTROS	9483501705 9483502205
11	712982	Barra di reazione angolare <i>Angle torque arm</i>	ACTROS	9483500905 9483502305
12	712876	Barra di reazione angolare / <i>Angle torque arm</i>	ACTROS MP2 - ACTROS MP3 AXOR 2	9483502905
13	730474	Kit revisione barra di reazione - PARTE CENTRALE <i>Torque arm repair kit</i>	AXOR - AXOR 2 ACTROS - ACTROS MP2	0003504905
14	730236	Kit revisione barra angolare - PARTE LATERALE <i>Angle torque arm repair kit</i>	ACTROS MP2 - ACTROS MP3 AXOR 2	0003502505 0003502205 0003504105
15	712992	Barra di reazione / <i>Torque arm</i>	ACTROS	9483501305 9483500605 9483501205 9483500006
16	730201	Kit revisione barra angolare - PARTE LATERALE <i>Angle torque arm repair kit</i>	ACTROS - ACTROS MP2 AXOR 2	0003502705
17	730200	Kit riparazione barra CON PERNO ø 80 <i>Torque arm repair kit C/W PIN</i> ø 80	Serie NG-MK-SK NG-MK-SK Series	0005861433 0003500213
18	730230	Kit riparazione barra con PERNO / <i>Torque arm repair kit C/W PIN</i>		3435860032
19	730881	Perno gommato balestra / <i>Spring pin</i>	ACTROS - ACTROS MP2 AXOR - AXOR 2	A0003330217
20	730490	Kit revisione barra di reazione <i>Torque arm repair kit</i>	AXOR ACTROS - ACTROS MP2	0003301411
21	730245	Kit revisione barra angolare - PARTE LATERALE <i>Angle torque arm repair kit</i>	ATEGO - AXOR - ACTROS	0003504705
22	730916	Kit revisione barra di reazione <i>Torque arm repair kit</i>	O 405 (BUS)	0003300707
23	730488	Kit revisione barra di reazione <i>Torque arm repair kit</i>	ATEGO - ATEGO2 - AXOR 2 ACTROS - ACTROS MP2	0003502105 0003504605
24	730472	Kit revisione barra di reazione <i>Torque arm repair kit</i>	ACTROS	0003502805
25	730202	Kit riparazione barra (perno gommato ø 95) <i>Torque arm repair kit</i>	Serie NG-SK NG-SK Series	0003500413 0005861235
26	730984	Kit revisione barra di reazione <i>Torque arm repair kit</i>	Serie SK - NG Series	0003500113

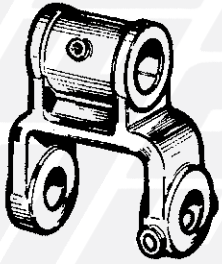


1 - 711323
 2 - 711322
 3 - 711324



711877
 4

NEW



724654
 5



725554
 6



725556
 7



725553
 8



725555
 9



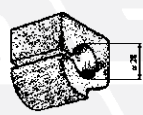
730932
 10



730931
 11



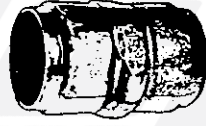
730953
 12



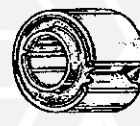
730954
 13



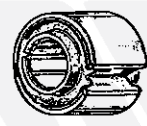
730487
 14



730375
 15



730374
 16



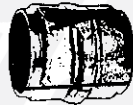
730373
 17



730483
 18



730919
 19



730484
 20



730486
 21



730485
 22



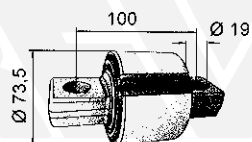
730326
 23



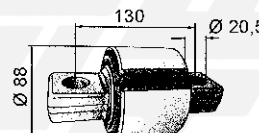
730285
 24



740061
 25



730476
 26



730475
 27

FIG. ITEM	RIF. ERREVI ERREVI REF.	DESCRIZIONE PARTICOLARI DESCRIPTION	TIPO VEHICLE MODEL	RIF. ORIG. ORIG. REF.
SOSPENSIONI / SUSPENSIONS				
1	711323	Complessivo revisione balestre posteriori <i>Rear spring repair kit</i>	1013 - 1213 - 1414 - 1614 - 2222	3853200065 3855860232
2	711322	Complessivo revisione balestre anteriori <i>Front spring repair kit</i>	1626 - 1919 - 2026 - 2636 - 3535	3953200165 3955860332
3	711324	Complessivo revisione balestre posteriori <i>Rear spring repair kit</i>	1626 - 1919 - 1926 - 2226 - 2236	3893200065 3895860132
4	711877	Kit revisione barra stabilizzatrice / <i>Stabilizer bar repair kit</i> composto da / <i>complete with:</i>	ACTROS	000323818551
	730373	(4) Boccola elastica / <i>Stabilizer bar bush</i>		0003238185
	730486	(2) Boccola elastica / <i>Stabilizer bar bush</i>		0003264481
		(4) Bulloni / <i>Bolt</i>		-
		(4) Rondelle / <i>Washers</i>		-
5	724654	Biscottino per balestra posteriore / <i>Rear spring shackle</i>	1626 - 1719 - 1922 - 1932 - 2026	3463205063
6	725554	Boccola per balestra e biscottino anteriore <i>Front spring eye and shackle bush</i>	∅ 25x30x67 709 - 814 - 1424 - 1824 - 2626 ATEGO - ACTROS	3523220050
7	725556	Boccola per balestra e biscottino posteriore <i>Rear spring eye and shackle bush</i>	∅ 30x35x77 1013 - 1413 - 1617 - 2224 - 2538	3963250050 3523250150
8	725553	Boccola per balestra e biscottino anteriore <i>Front spring eye and shackle bush</i>	∅ 25x30x81 1626 - 1922 - 2026 - 2626 - 3336	3043210150 6203210050
9	725555	Boccola per balestra posteriore / <i>Rear spring bush</i>	∅ 30x36x90 814 - 1424 - 2422 - 2626 ATEGO - ACTROS	3353240350
10	730932	Boccola elastica balestra / <i>Rubber bush</i>	∅ 18x66x96 ATEGO - ATEGO 2	3753200644 6753250485 9703200344
11	730931	Boccola elastica balestra / <i>Rubber bush</i>	∅ 22x74,5x96 ATEGO - ATEGO 2	9743200044
12	730953	Boccola elastica barra stabilizzatrice / <i>Rubber bush</i>	∅ 17x40x34 ATEGO	3183200073
13	730954	Boccola elastica barra stabilizzatrice ant. / <i>Rubber bush</i>	∅ int./I.D. 28 811 - 814 - 817	6733230385
14	730487	Boccola elastica fissaggio barra stabilizzatrice anteriore <i>Stabilizer bar bush, front</i>	∅ int. 28 L= 55 ACTROS	0003236285 0003237185
15	730375	Boccola elastica barra stabilizzatrice <i>Stabilizer bar bush</i>	∅ 40x50x55 ATEGO ACTROS	0003262481 0003262981 0003235985
16	730374	Boccola elastica barra stabilizzatrice <i>Stabilizer bar bush</i>	∅ 40x70x36/46 ACTROS	0003237985
17	730373	Boccola elastica barra stabilizzatrice <i>Stabilizer bar bush</i>	∅ 40x80x46 ATEGO ACTROS	0003238185
18	730483	Boccola elastica barra stabilizzatrice posteriore <i>Stabilizer bar bush, rear</i>	∅ int. 47 L= 56 AXOR - AXOR 2 ACTROS - ACTROS MP2	0003265081
19	730919	Boccola elastica barra stabilizzatrice <i>Stabilizer bar, bush</i>	∅ int. / inn. 48 L=57 ATEGO - ATEGO 2 - AXOR AXOR 2 - ACTROS	0003263281 0003263081 0003262681
20	730484	Boccola elastica barra stabilizzatrice posteriore <i>Stabilizer bar bush, rear</i>	∅ int. 52,5 L= 56 AXOR - AXOR 2 ACTROS - ACTROS MP2	0003265181
21	730486	Boccola elastica barra stabilizzatrice posteriore <i>Stabilizer bar bush, rear</i>	∅ int. 57,5 L= 56 ACTROS	0003264481 0003264781
22	730485	Boccola balestra posteriore <i>Silentblock, rear</i>	∅ int. 107 L= 170 ATEGO - AXOR - AXOR 2 ACTROS - ACTROS MP2	0003250485
23	730326	Boccola elastica occhio balestra posteriore <i>Silentblock</i>	∅ 24x62x96 ATEGO - ACTROS	0003221285 0003222285 0003223285
24	730285	Boccola elastica occhio balestra posteriore / <i>Silentblock</i>	∅ 24x62x106 ACTROS	0003250285
25	740061	Chiavetta fissaggio perno / <i>Cotter pin</i>	809 - 1413 - 1919 - 2232 - 3336	3529900337
26	730476	Perno gommato fissaggio barra stabilizzatrice anteriore <i>Stabilizer bar pin, front</i>	AXOR ACTROS - ACTROS MP2	9413230050
27	730475	Perno gommato fissaggio barra stabilizzatrice posteriore <i>Stabilizer bar pin, rear</i>	ATEGO - ATEGO 2 - AXOR - AXOR 2 ACTROS - ACTROS MP2	9423260050

1 MERCEDES



1 - 721821 \varnothing 14x180 T./Head h.13



2 - 721800 \varnothing 18x255 T./Head h.15
 3 - 721803 \varnothing 18x310 T./Head h.15
 4 - 721804 \varnothing 18x330 T./Head h.15



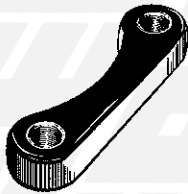
5 - 723961 \varnothing 16x84x180
 6 - 723964 \varnothing 16x84x240



7 - 723932 \varnothing 20x90x275



8 - 723926 \varnothing 24x100x435
 9 - 723927 \varnothing 24x100x460



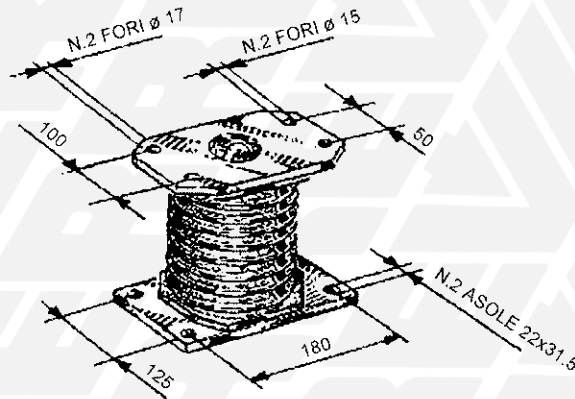
727952
 12



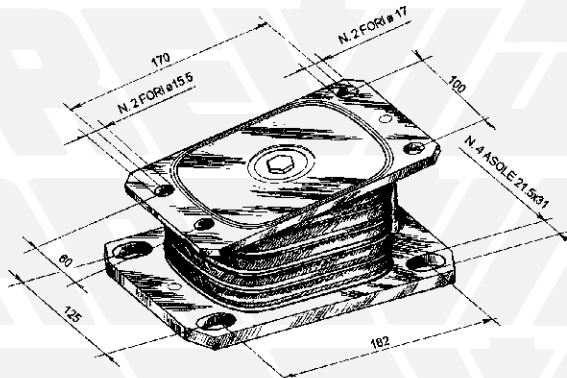
730479
 10



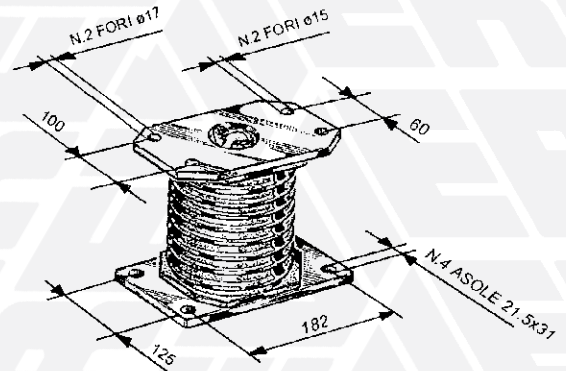
730480
 11



730078
 13



730088
 14



730089
 15

2 NISSAN



16 - 722012 \varnothing 12x65x220
 17 - 722009 \varnothing 12x65x250

FIG. ITEM	RIF. ERREVI ERREVI REF.	DESCRIZIONE PARTICOLARI DESCRIPTION		TIPO VEHICLE MODEL	RIF. ORIG. ORIG. REF.
<div style="display: flex; align-items: center;"> <div style="font-size: 2em; margin-right: 10px;">1</div> <div> <h2 style="margin: 0;">MERCEDES</h2> <h3 style="margin: 0;">SOSPENSIONI / SUSPENSIONS</h3> </div> </div>					
1	721821	Bullone centrale ant. testa fresata / <i>Centre bolt c/w nut</i>	∅ 14x180	ATEGO - ACTROS	-
2	721800	Bullone centrale post. / <i>Centre bolt c/w nut</i>	∅ 18x255	ATEGO - ACTROS	3463245071
3	721803	Bullone centrale post. / <i>Centre bolt c/w nut</i>	∅ 18x310	ATEGO - ACTROS	-
4	721804	Bullone centrale post. / <i>Centre bolt c/w nut</i>	∅ 18x330	ATEGO - ACTROS	-
5	723961	Staffa ant. semitonda c/dadi / <i>U bolt c/w nuts</i>	∅ 16x84x180	709 - 809 - 814 - 914 - ATEGO	3143510625
6	723964	Staffa ant. semitonda c/dadi / <i>U bolt c/w nuts</i>	∅ 16x84x240	709 - 814 - 1114 - 1314 - 1514	3163510025
7	723932	Staffa ant. semitonda piatta c/dadi / <i>U bolt c/w nuts</i>	∅ 20x90x275	1417 - 1926 - 2426 - 2635 - 3025	3043311925
8	723926	Staffa post. tonda piatta c/dadi / <i>U bolt c/w nuts</i>	∅ 24x100x435	2628 - 2636 - 3328 - 3535	-
9	723927	Staffa post. tonda piatta c/dadi / <i>U bolt c/w nuts</i>	∅ 24x100x460	2628 - 2636 - 3328 - 3535	-
10	730479	Tassello distanziale per foglia balestra ant. (LATO POSTERIORE) <i>Front spring buffer (rear side)</i>		ATEGO AXOR - AXOR 2 ACTROS - ACTROS MP2	9433235284 9433235384 9433238384 9433238684
11	730480	Tassello distanziale per foglia balestra ant. (LATO ANTERIORE) <i>Front spring buffer (front side)</i>		ATEGO AXOR - AXOR 2 ACTROS - ACTROS MP2	9433235184 9433236184 9433238484 9433238584
12	727952	Piastra ancoraggio tassello elastico <i>Spring core plate</i>		AXOR ACTROS	9473250226 9473250426
13	730078	Tassello elastico per balestra / <i>Spring core</i>		ACTROS	0003250596
14	730088	Tassello elastico per balestra / <i>Spring core</i>		ACTROS	0003250496
15	730089	Tassello elastico per balestra / <i>Spring core</i>		ATEGO - ACTROS	0003250896
<div style="display: flex; align-items: center;"> <div style="font-size: 2em; margin-right: 10px;">2</div> <div> <h2 style="margin: 0;">NISSAN</h2> <h3 style="margin: 0;">SOSPENSIONI / SUSPENSIONS</h3> </div> </div>					
16	722012	Staffa SEMITONDA c/dadi / <i>U bolt c/w nuts</i>	∅ 12x65x220		-
17	722009	Staffa SEMITONDA c/dadi / <i>U bolt c/w nuts</i>	∅ 12x65x250		-

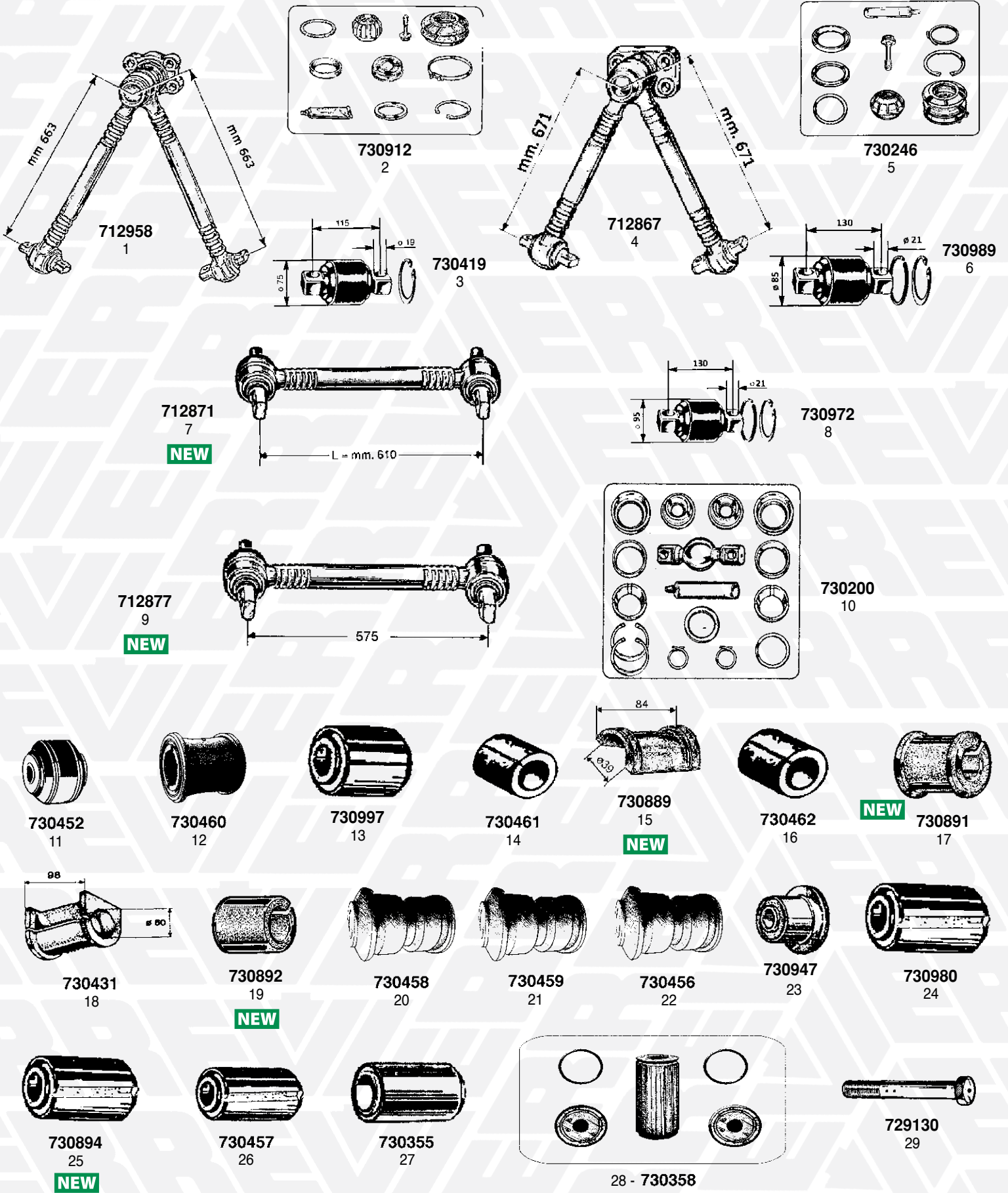
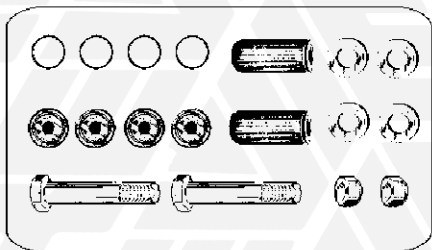
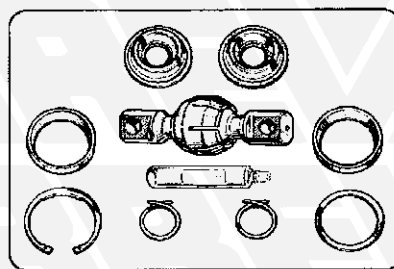


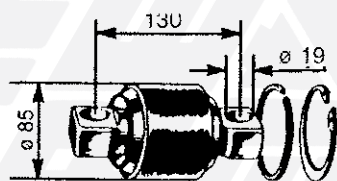
FIG. ITEM	RIF. ERREVI ERREVI REF.	DESCRIZIONE PARTICOLARI DESCRIPTION		TIPO VEHICLE MODEL	RIF. ORIG. ORIG. REF.
RENAULT					
SOSPENSIONI / SUSPENSIONS					
1	712958	Barra di reazione angolare / <i>Angle torque arm</i>		PREMIUM 2 - KERAX	7420741703
2	730912	Kit revisione barra di reazione angolare (PARTE CENTRALE) <i>Angle bar repair kit</i>		PREMIUM 2 - KERAX	7420741710
3	730419	Kit revisione barra di reazione / <i>Angle bar repair kit</i>		KERAX - PREMIUM - PREMIUM 2	7420547286
4	712867	Barra di reazione angolare / <i>Angle torque arm</i>		KERAX	7420829503 7421295227
5	730246	Kit revisione barra angolare - PARTE CENTRALE - <i>Angle torque arm repair kit</i>		KERAX	-
6	730989	Kit revisione barra di reazione / <i>Torque arm repair kit</i>		KERAX	7420840815
7	712871	Barra di reazione / <i>Torque arm</i>	L= 510 mm	KERAX Serie K Series	7421051052 7420522934
8	730972	Kit revisione barra di reazione / <i>Torque arm repair kit</i>		KERAX Serie K Series	7420702095
9	712877	Barra di reazione / <i>Torque arm</i>	L= 575	Serie C - G - R Series MAGNUM AE - MAGNUM E.TECH KERAX	5001850530 5000783574 5010064641 5010094838 5010094941 5010530366
10	730200	Kit riparazione barra con PERNO ø 80 <i>Torque arm repair kit c/w PIN ø 80</i>		Serie C - G - R Series MAGNUM AE - MAGNUM E.TECH KERAX	5001014345 5000819413
11	730452	Boccola elastica fissaggio barra stabilizzatrice ant. <i>Stabilizer bar bush, front</i>	ø 21 x 51 x 41	MIDLUM - PREMIUM - PREMIUM 2 MAGNUM - MAGNUM E.TECH	5010383545
12	730460	Boccola elastica fissaggio barra stabilizzatrice ant. <i>Stabilizer bar bush, front</i>	ø int. 25 L=49	MAGNUM KERAX	0000714088
13	730997	Boccola elastica barra stabilizzatrice / <i>Stabilizer bar rubber bush</i>	ø 28x57,5x64		7401134955
14	730461	Boccola elastica fissaggio barra stabilizzatrice ant. <i>Stabilizer bar bush, front</i>	ø int. 40 L=60	MIDLUM - PREMIUM - PREMIUM 2 MAGNUM - MAGNUM E.TECH	5010130022
15	730889	Semiboccola barra stabilizzatrice post. <i>Stabilizer bar half-bushing, rear</i>	ø int. 39 L=84	MAGNUM AE - MANAGER PREMIUM - PREMIUM 2	5010066936
16	730462	Boccola elastica fissaggio barra stabilizzatrice post. <i>Stabilizer bar bush, rear</i>	ø int. 52 L=74	PREMIUM - PREMIUM 2 MAGNUM - KERAX	5010060356
17	730891	Boccola barra stabilizzatrice post. / <i>Stabilizer bar bushing, rear</i>	ø 53x80x75	MAGNUM AE - MAGNUM Dxi MAGNUM E.TECH - PREMIUM	5010066937
18	730431	Boccola elastica fissaggio barra stabilizzatrice post. <i>Stabilizer bar bush, rear</i>	ø int. 60 L=98	PREMIUM - PREMIUM 2 KERAX	7401629169
19	730892	Boccola barra stabilizzatrice ant. <i>Stabilizer bar bushing, front</i>	ø 43x68x60	KERAX - MAGNUM AE MAGNUM Dxi - MAGNUM E.TECH PREMIUM - PREMIUM 2	5010560483 7482074380
20	730458	Boccola elastica supporto balestra ant. / <i>Rubber bush, front</i>	ø16x43x81	MIDLUM	5010294961
21	730459	Boccola elastica supporto balestra ant. / <i>Rubber bush, front</i>	ø16x43x95	MIDLINER - MIDLUM	5000448404
22	730456	Boccola elastica balestra post. / <i>Rubber bush, rear</i>	ø20x54x95	MIDLINER - MIDLUM	5000448405
23	730947	Boccola elastica balestra / <i>Rubber bush</i>	ø 24x60x63	MAGNUM - PREMIUM	7482139627 5001867795
24	730980	Boccola elastica balestra post. / <i>Silentblock, rear suspension</i>	ø 24x62x87	KERAX	7420839455 7422187008
25	730894	Boccola elastica per balestra / <i>Silentblock</i>	ø 24,5x61x96	Serie C-K Series	7422221048
26	730457	Boccola elastica sospensione pneumatica post. <i>Silentblock, rear</i>	ø24x61,5x96,5	PREMIUM - PREMIUM 2 MAGNUM - KERAX	5001859721
27	730355	Boccola elastica per sospensione pneumatica / <i>Silentblock</i>	ø30x70x104	MIDLUM - PREMIUM - MAGNUM	5001852218
28	730358	Boccola elastica occhio balestra completa / <i>Silentblock</i>	ø 20x44,7x104	MAGNUM - PREMIUM	5010060127
29	729130	Bullone fissaggio boccola barra stabilizzatrice ant. <i>Spring bolt</i>	M20x1,5 L=160	MIDLUM - PREMIUM - PREMIUM 2 MAGNUM - MAGNUM E.TECH	5010130738



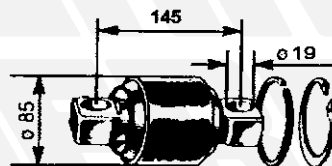
1 - 711056



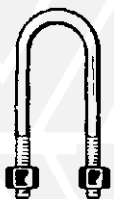
2 - 730465



730186
3



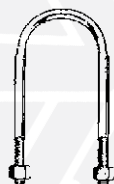
730463
4



5 - 722090 \varnothing 20x92x170
6 - 722091 \varnothing 20x92x215
7 - 722092 \varnothing 20x92x260



8 - 722096 \varnothing 24x91x420



9 - 722094 \varnothing 24x151x370



10 - 722093 \varnothing 24x101x420



11 - 724530

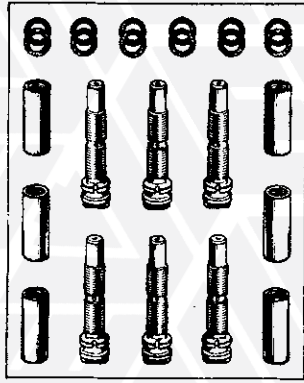
FIG. ITEM	RIF. ERREVI ERREVI REF.	DESCRIZIONE PARTICOLARI DESCRIPTION		TIPO VEHICLE MODEL	RIF. ORIG. ORIG. REF.
SOSPENSIONI / SUSPENSIONS					
1	711056	Complessivo revisione balestra anteriore <i>Spring repair kit, front</i>		KERAX - MAGNUM - MANAGER MAXTER - PREMIUM - PREMIUM 2	50100601275
2	730465	Kit revisione barra angolare (PARTE CENTRALE) / <i>Angle bar repair kit</i>		KERAX	5001823280
3	730186	Kit revisione barra / <i>Torque arm repair kit</i>			5001842823
4	730463	Kit revisione barra di reazione <i>Torque arm repair kit</i>		KERAX MAGNUM E.TECH	5000802123 5001831526
5	722090	Staffa balestra TONDA c/dadi / <i>U-bolt c/w nuts</i>	ø 20x92x170	PREMIUM	5010630363 5010600420
6	722091	Staffa balestra TONDA c/dadi / <i>U-bolt c/w nuts</i>	ø 20x92x215	MAGNUM - MAGNUM AE PREMIUM - PREMIUM 2	5010066498
7	722092	Staffa balestra TONDA c/dadi / <i>U-bolt c/w nuts</i>	ø 20x92x260	MAGNUM - MAGNUM AE MAGNUM E.TECH - PREMIUM PREMIUM 2 - KERAX	5010600294
8	722096	Staffa balestra SEMITONDA c/dadi / <i>U-bolt c/w nuts</i>	ø 24x91x420	KERAX	7420442795
9	722094	Staffa balestra TONDA PIATTA c/dadi / <i>U-bolt c/w nuts</i>	ø 24x151x370	PREMIUM - PREMIUM 2 MIDLUM - MAGNUM AE	5010488949
10	722093	Staffa balestra TONDA PIATTA c/dadi / <i>U-bolt c/w nuts</i>	ø 27x101x420	MAXTER - KERAX	5010383945 5010064803
11	724530	Supporto centrale bilanciante / <i>Trunnion</i>		PREMIUM - KERAX	7420429274



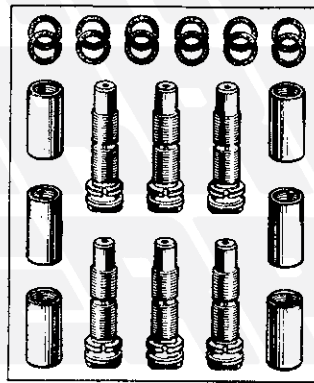
740028
3



740029
4



711329
1



711327
2



730377
9



730952
8



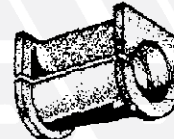
5 - 726087 \varnothing 36,1x90
6 - 726088 \varnothing 46,1x90
7 - 726089 \varnothing 46,1x100



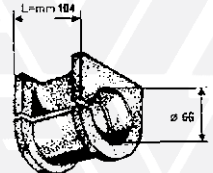
730379
12



730380
11



730979
10



730909
14



15 - 720178 \varnothing 28x166



730993
13



16 - 720179 \varnothing 36x168,5
17 - 720185 \varnothing 36x180



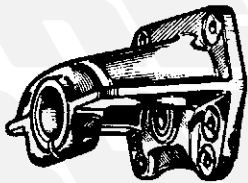
19 - 722128 \varnothing 20x93x225



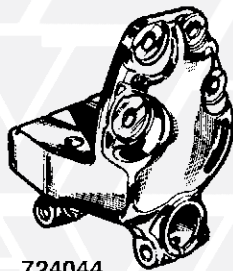
20 - 723797 \varnothing 22x90x220
21 - 723798 \varnothing 22x90x240



18 - 720182 \varnothing 36x130



724045
28



724044
27



22 - 722129 \varnothing 22x93x197
23 - 722130 \varnothing 22x93x240



730204
30

NEW



730376
29



NEW 31 - 730322

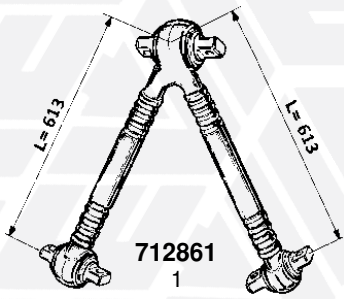


24 - 722131 \varnothing 24x103x280
25 - 722132 \varnothing 24x105x310



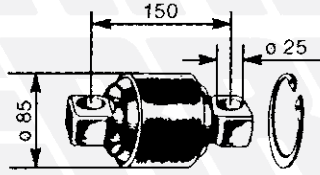
26 - 722133 \varnothing 30x95x400

FIG. ITEM	RIF. ERREVI ERREVI REF.	DESCRIZIONE PARTICOLARI DESCRIPTION		TIPO VEHICLE MODEL	RIF. ORIG. ORIG. REF.
SCANIA					
SOSPENSIONI / SUSPENSIONS					
1	711329	Complessivo revisione balestre ant. / Front spring repair kit		Tutti i tipi / All models	-
2	711327	Complessivo revisione balestre post. (boccole da mm. 90) Rear spring repair kit (bushes 90 mm.)		110 - 111 - 140 - 141 - 142	-
3	740028	Anello paragrasso perno balestra ant. / Front spring sealing ring		110 - 111 - 140 - 141 - 142	182929
4	740029	Anello paragrasso perno balestra post. / Rear spring sealing ring		110 - 111 - 140 - 141 - 142	182931
5	726087	Boccola in acciaio perno balestra ant. / Front spring steel bush	ø 36,1x90	Tutti i tipi / All models	128680
6	726088	Boccola in acciaio perno balestra post. Rear spring steel bush	ø 46,1x90	110 - 111 - 140 - 141 - 142	135036
7	726089	Boccola in acciaio perno balestra post. Rear spring steel bush	ø 46,1x100	94 - 114 - 124 - 144	135698
8	730952	Boccola elastica barra stabilizzatrice / Rubber bush	ø int. / I.D. 16 L= 24	Serie P - G - R - T Series	1516496
9	730377	Boccola elastica fissaggio barra stabilizzatrice ant. Stabilizer bar bush, front	ø 20 x 57 x 30	113 - 143 94 - 114 - 124 - 144	1429110 310808
10	730979	Boccola elastica barra stabilizzatrice ant. Front rubber bush, stabilizer bar	ø int. 60 L=105	Autobus Serie F-K-N F-K-N Bus series	1798776
11	730380	Boccola elastica fissaggio barra stabilizzatrice Rubber buffer	ø int. 40 L= 120	Serie 3 - 4 3 - 4 Series	213604
12	730379	Boccola elastica fissaggio barra stabilizzatrice ant. Rubber buffer, front	ø int. 50 L= 100	Serie 3 - 4 3 - 4 Series	228483
13	730993	Semiboccola barra stabilizzatrice / Stabilizer bar half-bushing	ø int. 84 L= 90	Serie P - G - R - T Series	1772693 1725213
14	730909	Boccola elastica barra stabilizzatrice / Stabilizer rubber bush	ø 65x104	94 - 114 - 124 - 144	1344190 1535026
15	720178	Perno ant. / Front spring pin	ø 28x166	94 - 114 - 124 - 144	128681 355145
16	720179	Perno post. da 90 mm. / Rear spring pin (leaf 90 mm.)	ø 36x168,5	94 - 114 - 124 - 144	135035 355147
17	720185	Perno post. da 100 mm. / Rear spring pin (leaf 100 mm.)	ø 36x180	114 - 124 - 144	202333 355148
18	720182	Perno supporto balestra post. - TESTA QUADRA - Rear spring pin (SQUARE HEAD)		R93 - G93 - P93 R112 - G112 - P112 R113 - P113 R142 - R143	355146 355149 246065
19	722128	Staffa balestra ant. SEMITONDA c/dadi / U-bolt c/w nuts	ø 20x93x225	Serie 3 Series	279065
20	723797	Staffa ant. semitonda c/dadi / U bolt c/w nuts, front	ø 22x90x220	141 - 142	-
21	723798	Staffa ant. semitonda c/dadi / U bolt c/w nuts, front	ø 22x90x240	141 - 142	-
22	722129	Staffa balestra ant. SEMITONDA c/dadi / U-bolt c/w nuts, front	ø 22x93x187	Serie 4 Series	1324367 1726129 2096130
23	722130	Staffa balestra ant. SEMITONDA c/dadi / U-bolt c/w nuts, front	ø 22x93x240	Serie 3 Series Serie 4 Series	1384444 1726133
24	722131	Staffa balestra post. SEMITONDA c/dadi / U-bolt c/w nuts, rear	ø 24x103x280	93 - 113 - 143 94 - 114 - 124 - 144 - 164	0363990 1859927
25	722132	Staffa balestra post. SEMITONDA c/dadi / U-bolt c/w nuts, rear	ø 24x105x310	Serie P - G - R - T Series Serie 4 Series	1739282 1397705 2030493
26	722133	Staffa balestra post. SEMITONDA PIATTA c/dadi U-bolt c/w nuts, rear	ø 30x95x400	Serie P - G - R - T Series Serie 4 Series	1384850 1858617
27	724044	Supporto ant. e post. balestra ant. / Front spring bracket		142 - 143	275460
28	724045	Supporto ant. e post. balestra post. / Rear spring bracket		142 - 143	283642
29	730376	Silentblock ammortizzatore / Shockabsorber rubber bush	ø 19,5 x 60 x 22,5	Serie 4 Series	307113
30	730204	Silentblock ammortizzatore Rubber buffer, rear		93 - 113 - 143 94 - 114 - 124 - 144 - 164 Serie P - G - R - T Series	1370142 1361156 1377692
31	730322	Tampone paracolpo balestra Rubber buffer		93 - 113 - 143 94 - 114 - 124 - 144 - 164 Serie P - G - R - T Series	222095



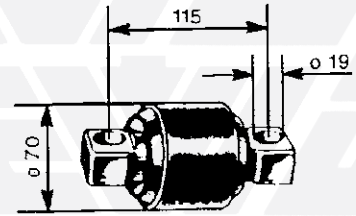
712861

1



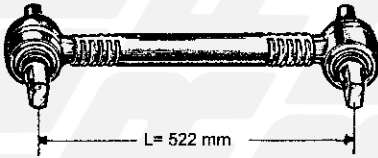
730235

2

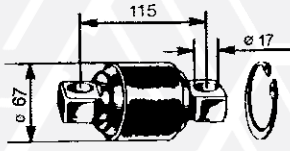


730956

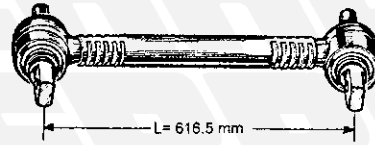
3



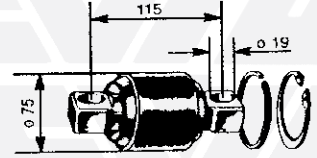
4 - 712993



5 - 730420



6 - 712994

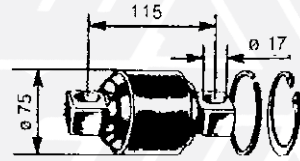


7 - 730419

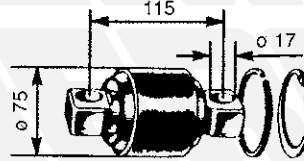


8 - 712875

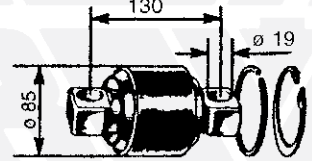
NEW



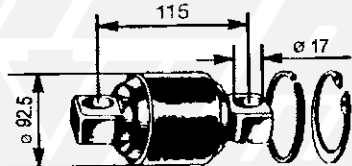
9 - 730916



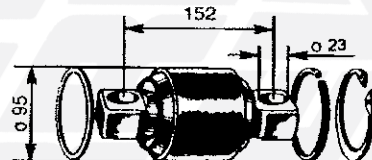
10 - 730242



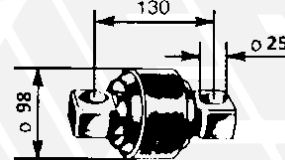
11 - 730186



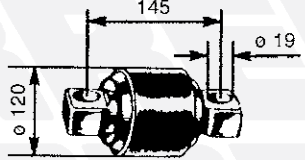
12 - 730418



13 - 730443



14 - 730992



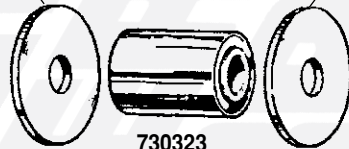
15 - 730243

726913

18

726913

18



730323

19



726924

20



729658

17



729416

16



730258

21



726638

22



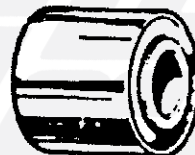
730323

24



726639

23



730327

25



729658

27



729436

26



28 - 723980 \varnothing 24x100x280

29 - 723981 \varnothing 24x100x300



729308

30



NEW

32 - 712301



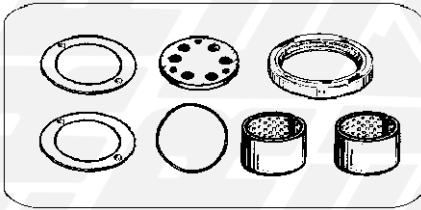
NEW

31 - 712300

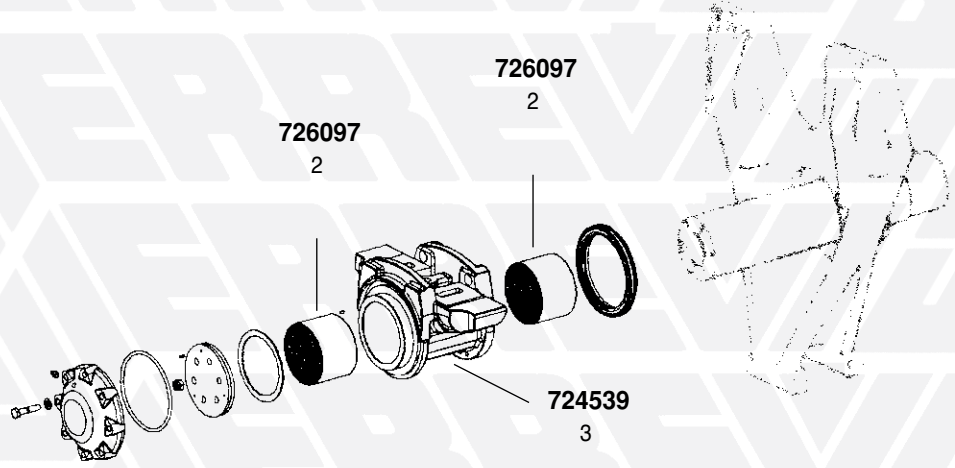
FIG. ITEM	RIF. ERREVI ERREVI REF.	DESCRIZIONE PARTICOLARI DESCRIPTION		TIPO VEHICLE MODEL	RIF. ORIG. ORIG. REF.
SOSPENSIONE POSTERIORE PNEUMATICA AIR SUSPENSION, REAR					
1	712861	Barra di reazione angolare posteriore / <i>Angle torque arm, rear</i>		Serie P - G - R - T Series	1722582 1440028
2	730235	Kit revisione barra angolare - PARTE CENTRALE <i>Angle torque arm repair kit</i>			1761964 1722584
3	730956	Kit revisione barra di reazione / <i>Angle torque arm repair kit</i>			1444472
4	712993	Barra di reazione / <i>Torque arm</i>	L= 522	93 - 113 - 143 94 - 114 - 124 - 144	1428349 1326775
5	730420	Kit revisione barra di reazione / <i>Torque arm repair kit</i>		94 - 114 - 124 - 144 - 164	550800
6	712994	Barra di reazione / <i>Torque arm</i>	L= 616,5	94 - 114 - 124	1485760 1499478 1722750
7	730419	Kit revisione barra di reazione / <i>Torque arm repair kit</i>		94 - 114 - 124 - 144 - 164	1515981 1722753
8	712875	Barra di reazione / <i>Torque arm</i>	L= 568 mm	94 - 114 - 124 - 144 - 164 Serie P - G - R - T Series	1428347
9	730916	Kit revisione barra di reazione / <i>Torque arm repair kit</i>		114 - 124 - 144 - 164 - 94	1104334 550806 639370
10	730242	Kit revisione barra / <i>Torque arm repair kit</i>		94 - 114 - 124 - 144	550799 1517403
11	730186	Kit revisione barra angolare / <i>Angle torque arm repair kit</i>		82 - 92 - 112 - 93 - 113 - 143 94 - 114 - 124 - 144 - 164	638862 639287
12	730418	Kit revisione barra di reazione / <i>Torque arm repair kit</i>		Serie 4 4 Series	1386753
13	730443	Kit revisione barra di reazione / <i>Torque arm repair kit</i>			1104336
14	730992	Kit revisione barra stabilizzatrice / <i>Stabilizer bar repair kit</i>		Serie P - G - R - T Series	1732460 1404313
15	730243	Perno gommato / <i>Torque arm repair kit</i>		93 - 113 - 143 124 - 144 - 164	248953 349254 1368682
16	729416	Perno tirante lato ant. / <i>Pin, front end</i>	ø 30x225	142 - 143	255315
17	729658	Dado per perno / <i>Nut</i>	M30x3,5	142 - 143	811911
18	726313	Rondella di spallamento / <i>Thrust washer</i>		142 - 143	272449
19	730323	Silentblock per occhio anteriore / <i>Spring eye rubber bush</i>	ø 30x65x106/122	G93 - P93 - R93 - P113 - R113 142-143	1362710
20	726924	Rondella distanziale per occhio balestra / <i>Spring eye washer</i>	ø 105x30,5x26		367494
21	730258	Silentblock per occhio balestra / <i>Spring eye rubber bush</i>	ø 30x65x102		362385
22	726638	Rondella di spallamento per silentblock / <i>Thrust washer</i>	ø 30,5x75,5 x107x16	G93 - P93 - R93 - P113 - R113	1117830
23	726639	Rondella di spallamento per silentblock / <i>Thrust washer</i>	ø 30,5x40,8 x75,5 x107x16	G93 - P93 - R93 - P113 - R113	1367370
24	730323	Silentblock per occhio anteriore / <i>Spring eye rubber bush</i>	ø 30x65x106/122	G93 - P93 - R93 - P113 - R113 142-143	1362710
25	730327	Silentblock supporto barra di reazione / <i>Silentblock</i>	ø 43/49x120,5x77		1368681
26	729436	Perno tirante / <i>Pin</i>	ø 30x250	G93 - P93 - R93 - P113 - R113	1338491
27	729658	Dado per perno / <i>Nut</i>	M30x3,5	G93 - P93 - R93 - P113 - R113 142-143	811911
28	723980	Staffa Semitonda c/dadi / <i>U bolt c/w nuts</i>	ø 24x100x280	143	1377799 1344870
29	723981	Staffa Semitonda c/dadi / <i>U bolt c/w nuts</i>	ø 24x100x300	143	-
30	729308	Dado speciale staffa balestra / <i>U bolt nut</i>	M24x3	143	1369806
31	712300	Tirante con testine per sospensione pneumatica / <i>Link rod</i>		94 - 114 - 124 - 144 - 164	1360884
32	712301	Tirante con testine per sospensione pneumatica / <i>Link rod</i>		94 - 114 - 124 - 144 - 164	1372151

BILANCIERE / EQUALIZER ASSY

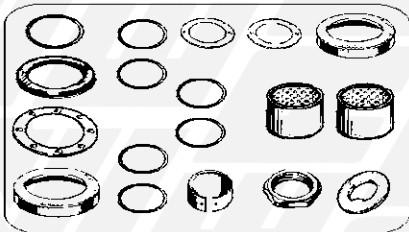
1



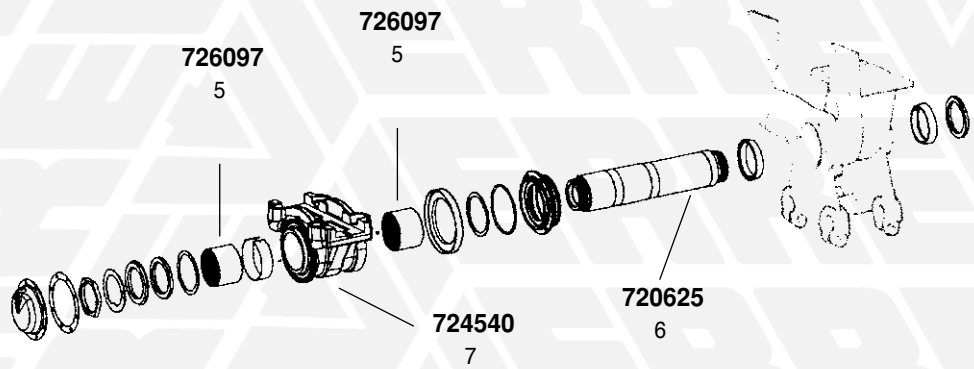
711208
1



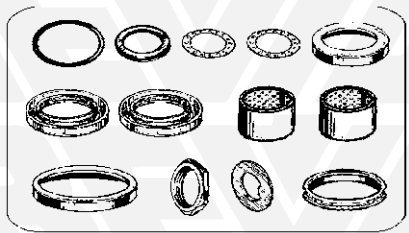
2



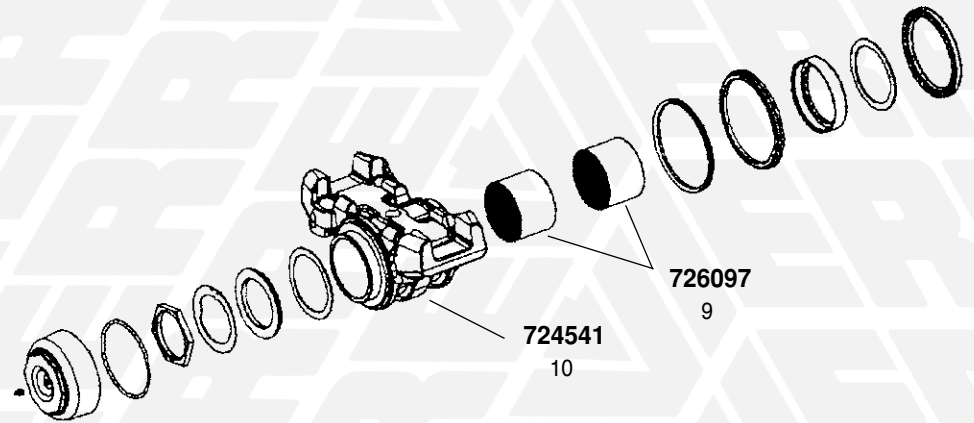
711209
4



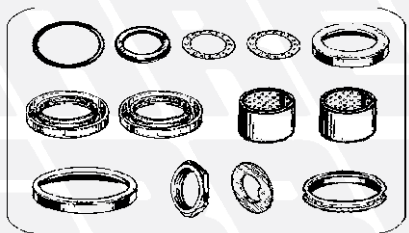
3



711207
8



4



711207
11

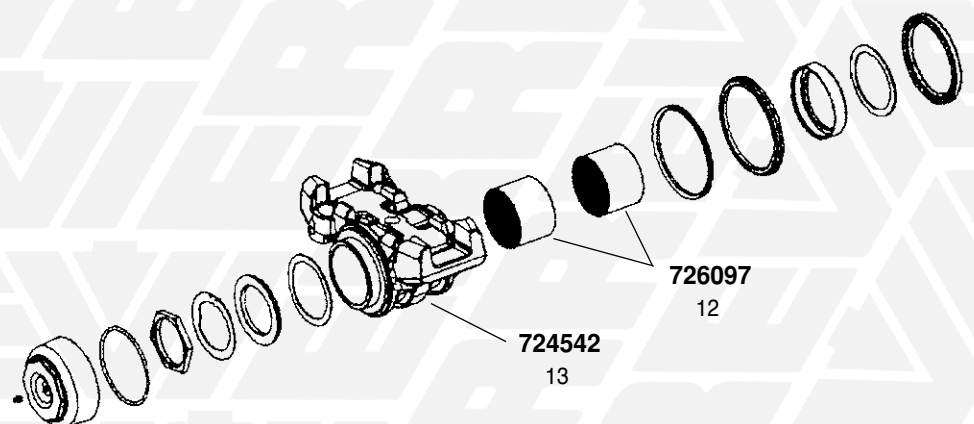
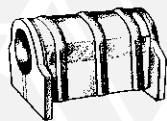


FIG. ITEM	RIF. ERREVI ERREVI REF.	DESCRIZIONE PARTICOLARI DESCRIPTION	TIPO VEHICLE MODEL	RIF. ORIG. ORIG. REF.
BILANCIERE / EQUALIZER ASSY				
①				
1	711208	Serie completa revisione bilanciere (1 sola PARTE) <i>Equalizer repair kit (SINGLE)</i>	93 - 113 - 143 94 - 114 - 124 - 144 - 164	13887835
2	726097	Boccola supporto bilanciere / <i>Trunnion bush</i>	ø 110x115,5x80 93 - 113 - 143 94 - 114 - 124 - 144 - 164	1754546 378277 204733
3	724539	Supporto centrale bilanciere / <i>Trunnion</i>	93 - 113 - 143 94 - 114 - 124 - 144 - 164	1382236 1388783
②				
4	711209	Serie completa revisione bilanciere (1 sola PARTE) <i>Equalizer repair kit (SINGLE)</i>	93 - 113 - 143 94 - 114 - 124 - 144 - 164	13799645
5	726097	Boccola supporto bilanciere / <i>Trunnion bush</i>	ø 110x115,5x80 93 - 113 - 143 94 - 114 - 124 - 144 - 164	1754546 378277 204733
6	720625	Perno centrale bilanciere / <i>Rocker beam pin</i>	ø 110x520 93 - 113 - 143 94 - 114 - 124 - 144 - 164	252497
7	724540	Supporto centrale bilanciere / <i>Trunnion</i>	93 - 113 - 143 94 - 114 - 124 - 144 - 164	1358274 1379964 204732
③				
8	711207	Serie completa revisione bilanciere (1 sola PARTE) <i>Equalizer repair kit (SINGLE)</i>	94 - 114 - 124 - 144 - 164 Serie P - G - R - T Series	17545465
9	726097	Boccola supporto bilanciere / <i>Trunnion bush</i>	ø 110x115,5x80 94 - 114 - 124 - 144 - 164 Serie P - G - R - T Series	1754546 378277 204733
10	724541	Supporto centrale bilanciere / <i>Trunnion</i>	94 - 114 - 124 - 144 - 164 Serie P - G - R - T Series	1404352 1399489
④				
11	711207	Serie completa revisione bilanciere (1 sola PARTE) <i>Equalizer repair kit (SINGLE)</i>	94 - 114 - 124 - 144 - 164 Serie P - G - R - T Series	17545465
12	726097	Boccola supporto bilanciere / <i>Trunnion bush</i>	ø 110x115,5x80 94 - 114 - 124 - 144 - 164 Serie P - G - R - T Series	1754546 378277 204733
13	724542	Supporto centrale bilanciere / <i>Trunnion</i>	94 - 114 - 124 - 144 - 164 Serie P - G - R - T Series	1422961

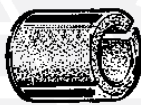
SOSPENSIONE ANTERIORE / FRONT SUSPENSION



730997
1



730439
2

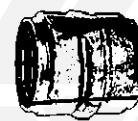


730892
3

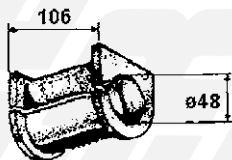
NEW



730438
4

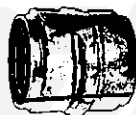


730964
5

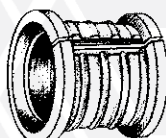


730897
6

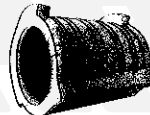
NEW



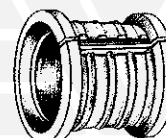
730965
7



730440
8



730434
9



730441
10



730466
11



730352
12



730967
13



730968
14



16 - 725815
17 - 725812



720210
21



720211
22



720233
20



725593
15



720226
18



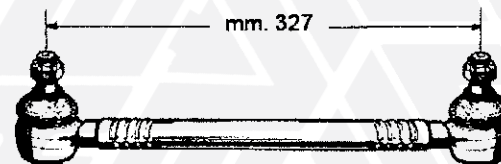
720227
19



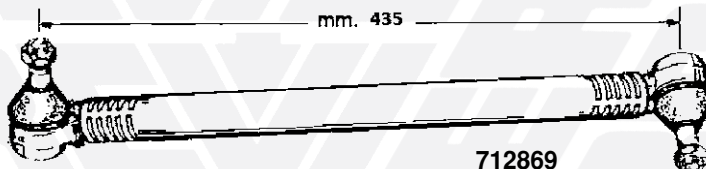
23 - 723971 \varnothing 20x100x210 passo 2,5
24 - 722095 \varnothing 20x100x285 passo 2,5



730429
25



712537
26



712869
27

FIG. ITEM	RIF. ERREVI ERREVI REF.	DESCRIZIONE PARTICOLARI DESCRIPTION		TIPO VEHICLE MODEL	RIF. ORIG. ORIG. REF.
VOLVO					
SOSPENSIONE ANTERIORE / FRONT SUSPENSION					
1	730997	Boccola elastica barra stabilizzatrice <i>Stabilizer bar rubber bush</i>	ø 28x57,5x64	FM10 - FM12 FL - FL7 - FL10 - FL12 FH12 - FH16 - F10 - F12	1190030 1134955
2	730439	Boccola elastica fissaggio barra stabilizzatrice <i>Silentblock stabilizer bar</i>	ø int. 35 L=89	FM10 - FM12 FH12 - FH16	1075179
3	730892	Boccola barra stabilizzatrice ant. / <i>Stabilizer bar bushing, front</i>	ø 43x68x60	FE	20752549 82074380
4	730438	Boccola elastica fissaggio barra stabilizzatrice <i>Silentblock stabilizer bar</i>	ø int. 44 L=87,5	FM10 - FM12 FH12 - FH16	1075180
5	730964	Boccola elastica fissaggio barra stabilizzatrice <i>Silentblock, stabilizer bar</i>	ø int. / inn. 48 L=71	FH12 - FH16 - FL6 - FM9 - FM12	3173991
6	730897	Boccola elastica fissaggio barra stabilizzatrice <i>Stabilizer bar rubber bush</i>		F10 - F12	1573032
7	730965	Boccola elastica fissaggio barra stabilizzatrice <i>Silentblock, stabilizer bar</i>	ø int. / inn. 55 L=70	FH12 - FH16 - FM10 - FM12 - FM7 FM9 - FM	3173993
8	730440	Boccola elastica fissaggio barra stabilizzatrice <i>Silentblock stabilizer bar</i>	ø int. 55 L=94	FM7 - FM9 - FM10 - FM12 FH12 - FH16	9516524 3028449
9	730434	Boccola elastica fissaggio barra stabilizzatrice <i>Silentblock stabilizer bar</i>	ø int. 60 L=74	FM7 - FM9 FH12 - FH16	1075188
10	730441	Boccola elastica fissaggio barra stabilizzatrice <i>Silentblock stabilizer bar</i>	ø int. 60 L=95	FM7 - FM10 FH12 - FH16	9519245
11	730466	Boccola balestra <i>Spring bush</i>	ø 16x50x95	FL6	6879332
12	730352	Boccola balestra <i>Spring bush</i>	ø 20.4x52x110	FM9 - FM12 - FH12 - FH16	20533294
13	730967	Boccola balestra <i>Spring bush</i>	ø 24x50,5x110	F10 - F12 - F16 - FH12 - FH16 FL10 - FL6 - FL7 FM10 - FM12 - FM7 - FM9	20945984
14	730968	Boccola balestra <i>Spring bush</i>	ø 24x51,5x110	F10 - F12 - F16 - FH12 - FH16 FL10 - FL6 - FL7 FM10 - FM12 - FM7 - FM9	20959115
15	725593	Boccola balestra e biscottino <i>Spring and shackle bush</i>	ø est. 45x105 M33x4	FH 12	1075726
16	725815	Boccola balestra / <i>Spring bush</i>	ø est. 45x110 M36x3	F10 - F12	310947
17	725812	Boccola balestra / <i>Spring bush</i>	ø est. 45x105 M36x3	F7 - FL7 - F10 - FL10 - F12 - F16	1504550
18	720226	Perno balestra e biscottino - lato anteriore <i>Spring and schakle pin, front</i>	M33x4 L=170	FH 12	1076334
19	720227	Perno balestra - Lato posteriore / <i>Spring pin, rear</i>	M33x4 L=170	FH 12	1075723
20	720233	Perno balestra anteriore / <i>Spring pin, front end</i>	M34x4 L=201	FM9 - FM12 - FH12 - FH16	20427987
21	720210	Perno balestra - Lato ant. e post. - / <i>Pin, front and rear end</i>	M36x3 L=168	FL7 - FL10 - F12 - F16	1614230
22	720211	Perno balestra - Lato post. - / <i>Pin, rear end</i>	M36x3 L=168	FL7 - FL10 - F12 - F16	1614229
23	723971	Staffa QUADRA c/dadi / <i>U bolt c/w nuts</i>	ø 20x100x210 passo/pitch 2,5	F7 - FL7 - F10 - FL10 - F12 - F16	1590939
24	722095	Staffa balestra QUADRA c/dadi / <i>U-bolt c/w nuts</i>	ø 20x100x285 passo/pitch 2,5	F10 - F12 - F16 - FL7 - FL10 - FL12 FH12 - FH16	20442790 1590942
25	730429	Tassello distanziale per foglia balestra <i>Spring buffer</i>		FM7 - FM9 - FM10 - FM12 FH12 - FH16	1626139
26	712537	Tirante completo barra stabilizzatrice <i>Stabilizer bar rod</i>	L=327 mm	FM7-FM9-FM10-FM12 FH12-FH16	1629668 3986433 21446333
27	712869	Tirante completo barra stabilizzatrice / <i>Stabilizer bar rod</i>	L=435 mm	FH12 - FH16 - FH FM10 - FM12 - FM	21287061 21119064

SOSPENSIONE POSTERIORE / REAR SUSPENSION

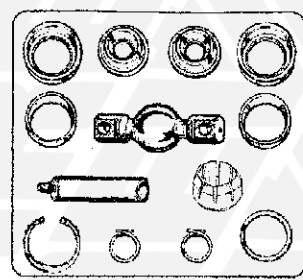
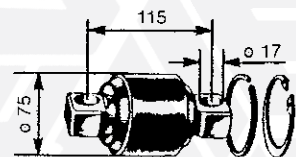
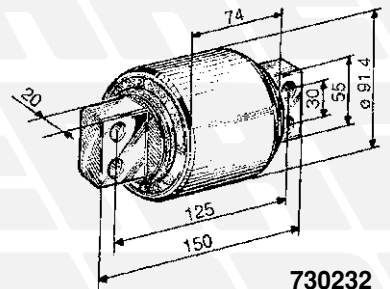
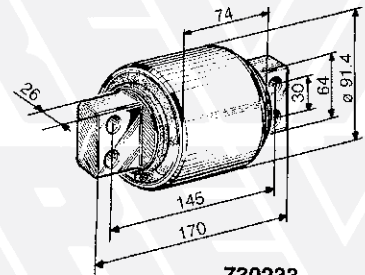
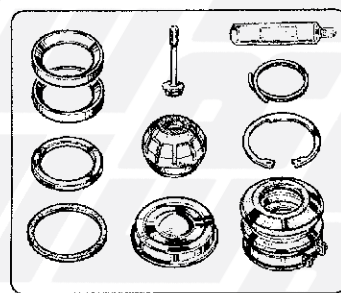
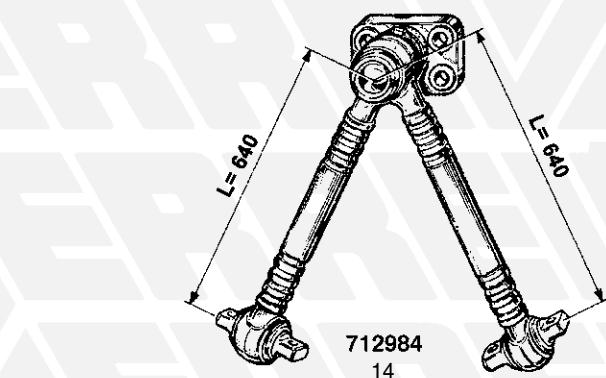
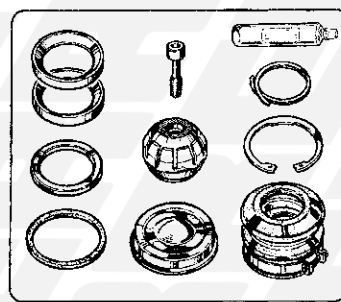
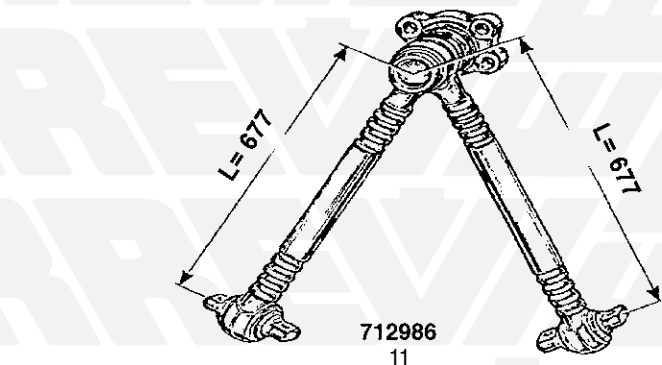
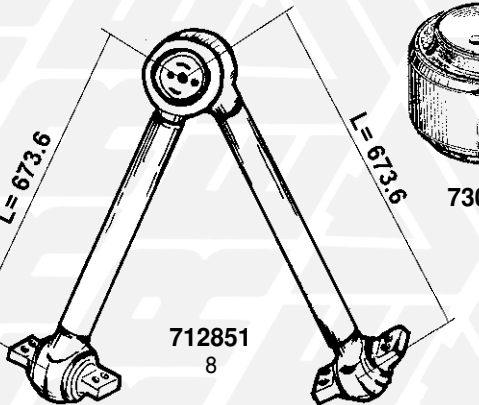
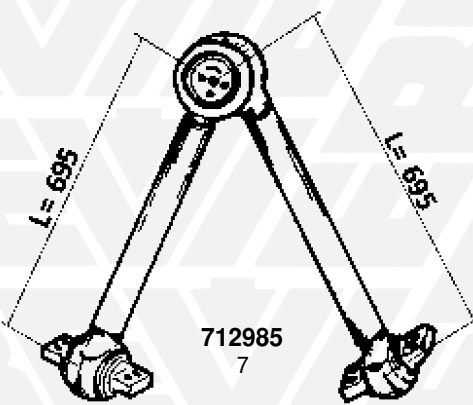
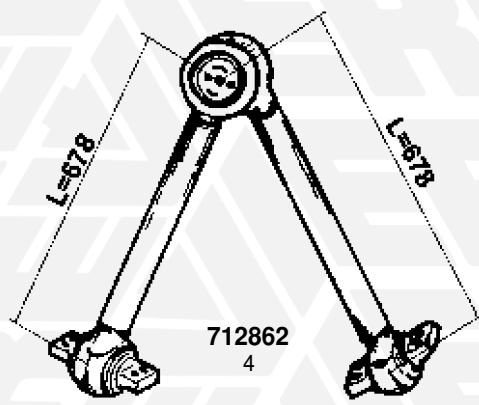
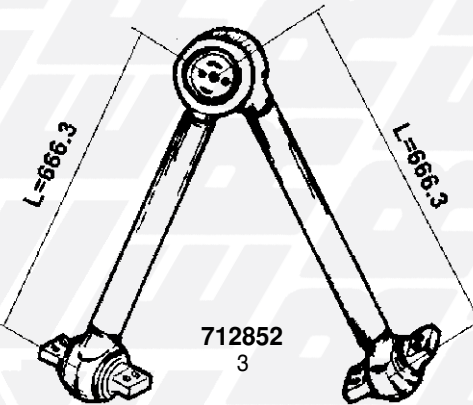
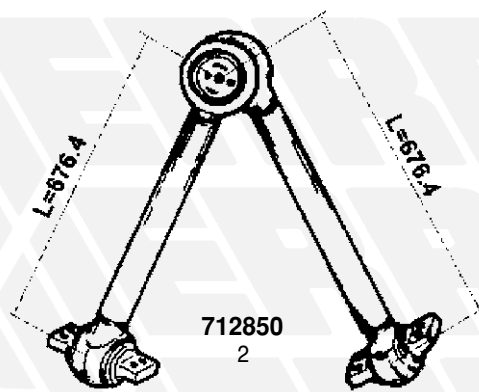
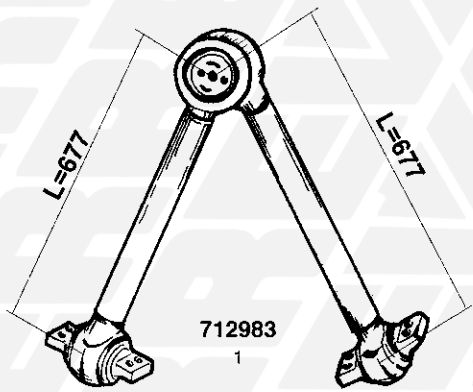
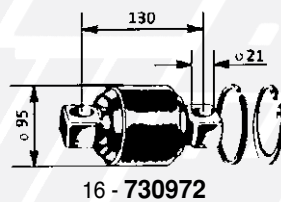
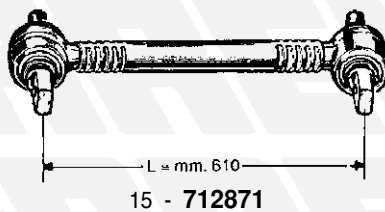
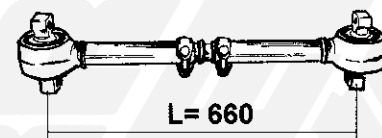
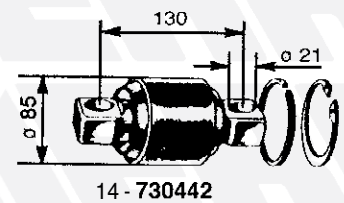
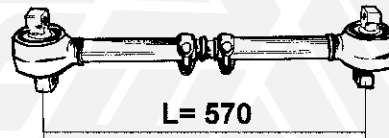
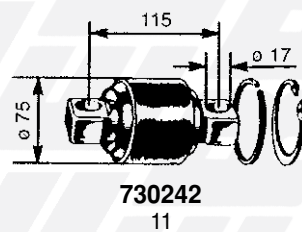
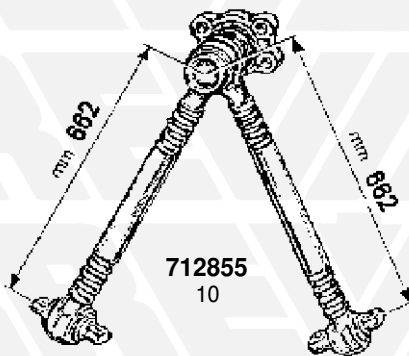
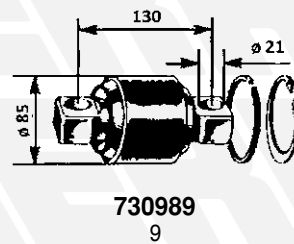
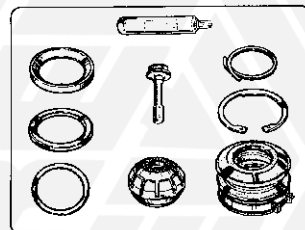
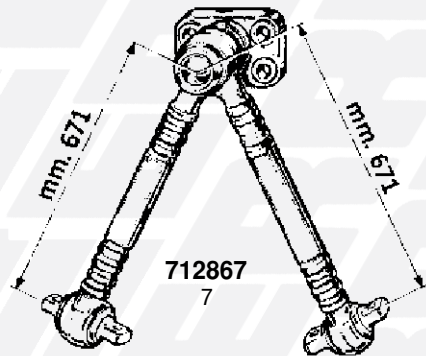
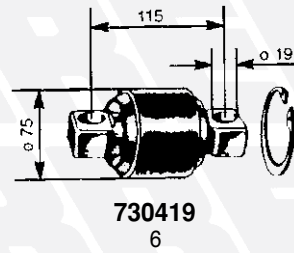
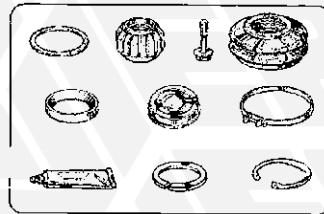
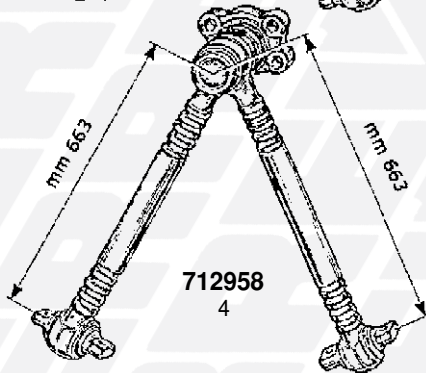
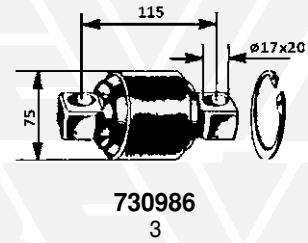
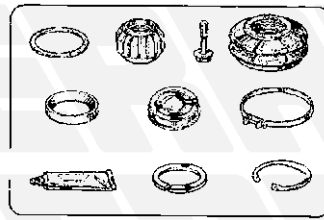
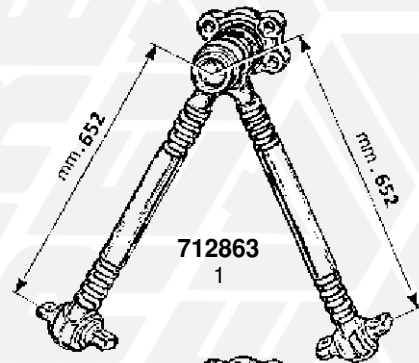


FIG. ITEM	RIF. ERREVI ERREVI REF.	DESCRIZIONE PARTICOLARI DESCRIPTION		TIPO VEHICLE MODEL	RIF. ORIG. ORIG. REF.
SOSPENSIONE POSTERIORE / REAR SUSPENSION					
1	712983	Barra di reazione angolare / <i>Angle torque arm</i>		FM7 - FM10 - FM12 - FH12 - FH16	1628133 3173291 8156991 20556490
2	712850	Barra di reazione angolare / <i>Angle torque arm</i>	L= 676,4	FH12	20556493 3173297
3	712852	Barra di reazione angolare / <i>Angle torque arm</i>	L= 666,3	FM7 - FM12 - FH12	20556488 3173289
4	712862	Barra di reazione angolare posteriore / <i>Angle torque arm, rear</i>		FH12 - FH16 - FM7 - FM10 - FM12	3173292 20556491 8156992
5	730231	Boccola gommata barra angolare - PARTE CENTRALE - <i>Rubber bush</i>		FM7 - FM10 - FM12 - FH12 - FH16	20554908 1075255 1591689
6	730233	Perno gommato barra angolare / <i>Rubber mounting</i>		FM7 - FM10 - FM12 - FH12 - FH16	1628107
7	712985	Barra di reazione angolare / <i>Angle torque arm</i>		F7 - F10 - F12 - F16 - FL7 - FL10 FL12	1605244 3173294 8156994 20556586 1628483
8	712851	Barra di reazione angolare / <i>Angle torque arm</i>	L= 673,6	F10 - F12 - FL10 - FL12	20556588 3173290
9	730231	Boccola gommata barra angolare - PARTE CENTRALE - <i>Rubber bush</i>		F7 - F10 - F12 - F16 - FL7 - FL10 FL12	1075255 1591689 20554908
10	730232	Perno gommato barra angolare - PARTE LATERALE - <i>Rubber mounting</i>		F7 - F10 - F12 - F16 - FL7 - FL10 FL12	1598588
11	712986	Barra di reazione angolare / <i>Angle torque arm</i>		FM7 - FM10 - FM12 - FH12 - FH16	3172829
12	730206	Kit revisione barra angolare - PARTE CENTRALE - <i>Angle bar repair kit</i>		FL7 - FL10 - FL12 - F12 - F16	271188
13	730242	Kit revisione barra / <i>Torque arm repair kit</i>		FM9 - FM12 - FH12 - FH16	3093462 271187
14	712984	Barra di reazione angolare <i>Angle torque arm</i>		FL7 - FL10 - FL12 F10 - F12 - F16 - N10	1080690 1606200
15	730240	Kit revisione barra angolare - PARTE CENTRALE - <i>Angle bar repair kit</i>		F7 - FL7 - F10 - FL10 - N10 - N12	273706
16	730241	Kit revisione barra angolare / <i>Angle bar repair kit</i>		F7 - FL7 - F10 - FL10 - N10 - N12	273375

SOSPENSIONE POSTERIORE / REAR SUSPENSION



NEW

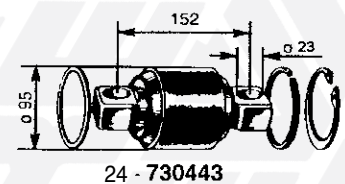
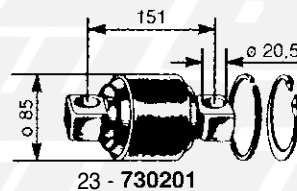
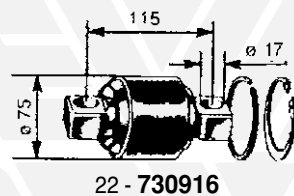
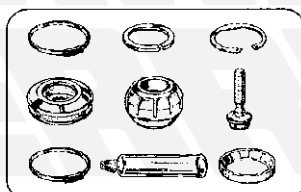
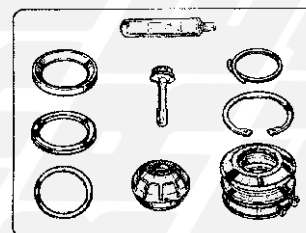
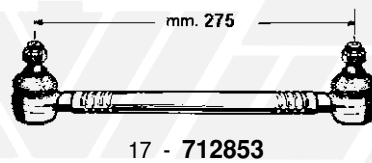
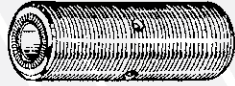


FIG. ITEM	RIF. ERREVI ERREVI REF.	DESCRIZIONE PARTICOLARI DESCRIPTION		TIPO VEHICLE MODEL	RIF. ORIG. ORIG. REF.
segue SOSPENSIONE POSTERIORE / cont'd REAR SUSPENSION					
1	712863	Barra di reazione angolare / <i>Angle torque arm</i>		FL6 - FL12 - FL	20382314 1094466 20502944
2	730912	Kit revisione barra di reazione angolare - PARTE CENTRALE - <i>Angle bar repair kit</i>		FM7 - FM9 - FM12 - FM FL6 - FH12 - FH16	20741710 3093544
3	730986	Kit revisione barra di reazione / <i>Torque arm repair kit</i>		FL6 - FL12 - FL - FH12 - FH16 - FH FM7 - FM9 - FM10 - FM12 - FM	3090452 3092452
4	712958	Barra di reazione angolare / <i>Angle torque arm</i>		FM7 - FM10 - FM12 FH12 - FH16	20367004 20507262 20741695 20741703
5	730912	Kit revisione barra di reazione angolare - PARTE CENTRALE - <i>Angle bar repair kit</i>		FM7 - FM9 - FM12 - FM FL6 - FH12 - FH16	20741710 3093544
6	730419	Kit revisione barra di reazione / <i>Angle bar repair kit</i>		FH12 - FH16 - FM - FM12	20547286
7	712867	Barra di reazione angolare / <i>Angle torque arm</i>		FH12 - FH16 - FH FM9 - FM12 - FM	1076639 1626896 1629734 20392649 20829503 21295227 21513940
8	730246	Kit revisione barra angolare - PARTE CENTRALE - <i>Angle torque arm repair kit</i>		FM7 - FM10 - FM12 FH12 - FH16	3090712
9	730989	Kit revisione barra di reazione / <i>Torque arm repair kit</i>		FH12 - FH16 - FH FM9 - FM12 - FM	20840815 3093630 3093631
10	712855	Barra di reazione angolare / <i>Angle torque arm</i>		FM9 - FM12 - FH12 - FH16 FM - FH	20703338 20556608 20491771 20589061 22238525
11	730242	Kit revisione barra / <i>Torque arm repair kit</i>		FM9 - FM12 - FH12 - FH16	3093462 271187
12	712995	Barra di reazione / <i>Torque arm</i>	L= 660 mm	F10 - F12 - F16 - FL7 - FL10 - FL12 N10 - N12 - NL10 - NL12	1581527 1607079 8154017 8158206 8158207
13	712996	Barra di reazione / <i>Torque arm</i>	L= 570 mm	FM7 - FM9 - FM12 NH12 - FH12 - FH16	1626958
14	730442	Kit revisione barra di reazione <i>Torque arm repair kit</i>		F12 - FL10 - FL12 FH16	273373 274019 4941233
15	712871	Barra di reazione <i>Torque arm</i>	L= 510 mm	FH12 - FH16 - FH FM9 - FM12 - FM - NH12	21051052 20522934
16	730972	Kit revisione barra di reazione / <i>Torque arm repair kit</i>		FH12 - FH16 - FH FM - FM9 - FM12	20702095 273612 4881628
17	712853	Barra di reazione / <i>Torque arm</i>	L= 275	FM - FM9 - FM12 FH12 - FH16 - FH	20477803 3987423
18	730246	Kit revisione barra angolare - PARTE CENTRALE - <i>Angle torque arm repair kit</i>		FM7 - FM10 - FM12 FH12 - FH16	3090712
19	730422	Silentblock per barra di reazione <i>Silentblock</i>	ø 52x92x85	F10 - F12 - F16 FL6 - FL7 - FL10 - FL12 FM7 - FM10 - FM12 FH12 - FH16 - B12	1135080
20	711822	Kit revisione barra di reazione / <i>Torque arm repair kit</i>		FM9 - FM12 - FH12 - FH16	20557378
21	730991	Kit revisione barra di reazione / <i>Torque arm repair kit</i>		FH12 - FH16 - FH FM9 - FM12 - FM	20840820
22	730916	Kit revisione barra di reazione / <i>Torque arm repair kit</i>		F10 - F12 - F16 FL7 - FL10 - FL12 - N10	271187 11043031
23	730201	Kit revisione barra angolare / <i>Angle bar repair kit</i>		FL7 - FL10 - F7 - F10 - F12 N10 - N12	274068
24	730443	Kit revisione barra di reazione <i>Torque arm repair kit</i>		F12 - FL10 - FL12 FH16	274056 276192

**SOSPENSIONE
SUSPENSION**



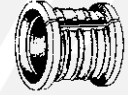
1 - 725811
2 - 725812



7 - 725813



8 - 730997



9 - 730987



3 - 730967
4 - 730968



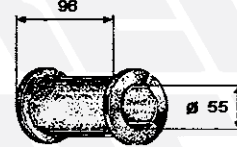
5 - 730980
6 - 730894 **NEW**



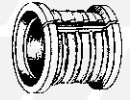
730367
10



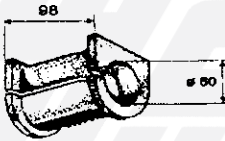
11 - 730964
12 - 730965



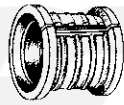
730430
13



14 - 730441
15 - 730433



730431
16



17 - 730437
18 - 730435
19 - 730432



730466
20



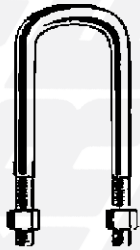
730424
21



720233
22



723955 \varnothing 24x130x290
23



26 - 722097 \varnothing 24x102x410



27 - 722098 \varnothing 24x102x210
28 - 722099 \varnothing 24x102x260



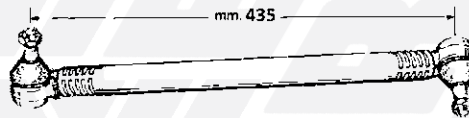
24 - 723975 \varnothing 24x100x350 passo 3
25 - 723977 \varnothing 24x100x390 passo 3



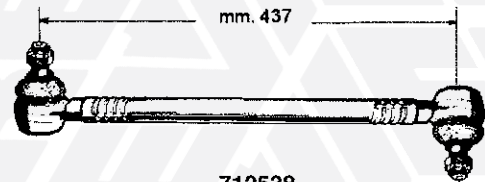
29 - 722096 \varnothing 24x91x420



730429
30



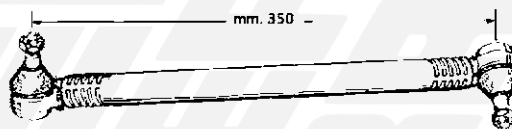
712856
32



712538
33

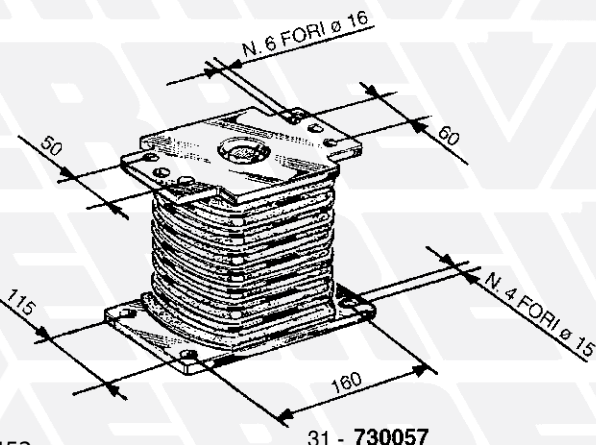


712539
34



712854
35

NEW



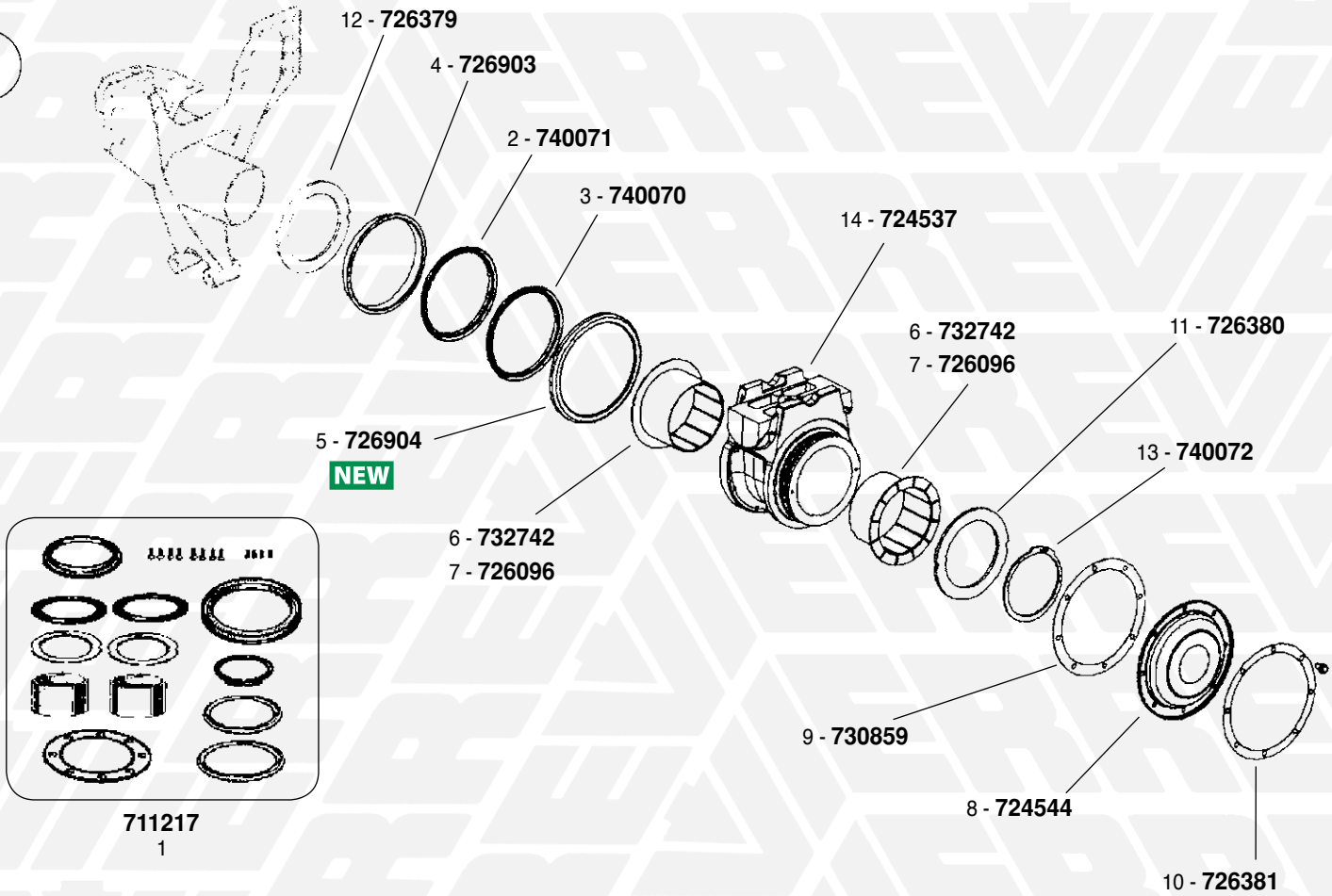
31 - 730057

FIG. ITEM	RIF. ERREVI ERREVI REF.	DESCRIZIONE PARTICOLARI DESCRIPTION		TIPO VEHICLE MODEL	RIF. ORIG. ORIG. REF.
segue SOSPENSIONE POSTERIORE / cont'd REAR SUSPENSION					
1	725811	Boccola balestra e biscottino U.T. <i>Spring and shackle bush</i>	∅ est. 55x105 M45x3	FL7 - F10 - FL10 - F12 - F16	1598721
2	725812	Boccola balestra / <i>Spring bush</i>	∅ est. 45x105 M36x3	F7 - F12 - N10 - N12	1504550
3	730967	Boccola balestra / <i>Spring bush</i>	∅ 24x50,5x110	F10 - F12 - F16 - FH12 - FH16 - FL10 FL6 - FL7 - FM10 - FM12 - FM7 - FM9	20945984
4	730968	Boccola balestra / <i>Spring bush</i>	∅ 24x51,5x110	F10 - F12 - F16 - FH12 - FH16 - FL10 FL6 - FL7 - FM10 - FM12 - FM7 - FM9	20959115
5	730980	Boccola elastica balestra post. / <i>Silentblock, rear suspension</i>	∅ 24x62x87	FE	20839455
6	730894	Boccola elastica per balestra / <i>Silentblock</i>	∅ 24,5x61x96	FH - FM - NH	22221048
7	725813	Boccola balestra U.T. / <i>Spring bush</i>	∅ 25x112 M45x3	FL7 - FL10 - F16	1608019
8	730997	Boccola elastica barra stabilizzatrice / <i>Stabilizer bar rubber bush</i>	∅ 28x57,5x64	FM10 - FM12 - FL - FL7 - FL10 FL12 - FH12 - FH16 - F10 - F12	1190030 1134955
9	730987	Boccola elastica barra stabilizzatrice ant./post. <i>Stabilizer bar rubber bush, front and rear</i>	∅ 49,5 L=95	B12 FL6	9959304 9516523 3028448 1137960
10	730367	Boccola elastica barra stabilizzatrice / <i>Silentblock stabilizer bar</i>	∅ 34x64,5x64	FM7 - FM9 - FM10 - FH12 - FH16	1620750
11	730964	Boccola elastica barra stabilizzatrice / <i>Silentblock, stabilizer bar</i>	∅ int. / inn. 48 L=71	FH12 - FH16 - FL6 - FM9 - FM12	3173991
12	730965	Boccola elastica barra stabilizzatrice / <i>Silentblock, stabilizer bar</i>	∅ int. / inn. 55 L=70	FH12 - FH16 - FM10 - FM12 - FM7 FM9 - FM	3173993
13	730430	Boccola elastica barra stabilizzatrice / <i>Silentblock stabilizer bar</i>	∅ int. 55 L=96	F10-F12-F16-FL7-FL10-FL12-FH12-FH16	1605182
14	730441	Boccola elastica barra stabilizzatrice / <i>Silentblock stabilizer bar</i>	∅ int. 60 L=95	FM7 - FM10 - FH12 - FH16	9519245
15	730433	Boccola elastica barra stabilizzatrice / <i>Silentblock stabilizer bar</i>	∅ int. 60 L=96	F10-F12-F16-FL7-FL10-FL12-FH12-FH16	1605047
16	730431	Boccola elastica barra stabilizzatrice / <i>Silentblock stabilizer bar</i>	∅ int. 60 L=98	FM7 - FH12 - FH16	1629169
17	730437	Boccola elastica barra stabilizzatrice / <i>Silentblock stabilizer bar</i>	∅ int. 65 L=95	FM7 - FM9 - FM10 - FM12 - FH12 - FH16	1079256
18	730435	Boccola elastica barra stabilizzatrice / <i>Silentblock stabilizer bar</i>	∅ int. 62 L=96	F10 - F12 - F16 - FL6 - FL7 - FL10 FL12 - FH12 - FH16	1607561
19	730432	Boccola elastica barra stabilizzatrice / <i>Silentblock stabilizer bar</i>	∅ int. 75 L=95	FL7 - FL10 - FL12 - FH12 - FH16	1622838
20	730466	Boccola balestra / <i>Spring bush</i>	∅ 16x50x95	FL6	6879332
21	730424	Boccola balestra / <i>Spring bush</i>	∅ 26x56x112	FL6 - FM7 - FH12 - FH16	1624486
22	720233	Perno balestra anteriore / <i>Spring pin, front end</i>	M34x4 L= 201	FM9 - FM12 - FH12 - FH16	20427987
23	723955	Staffa tonda c/dadi - sospensione Pneumatica - <i>U bolt c/w nuts - Air Suspension -</i>	∅ 24x130x290	3° asse	-
24	723975	Staffa quadra piatta c/dadi / <i>U bolt c/w nuts</i>	∅ 24x100x350 passo 3	F7 - FL7 - F10 - FL10 - F12	1590925
25	723977	Staffa quadra piatta c/dadi / <i>U bolt c/w nuts</i>	∅ 24x100x390 passo 3	F7 - FL7 - F10 - FL10 - F12	1590927
26	722097	Staffa balestra SEMITONDA c/dadi / <i>U-bolt c/w nuts</i>	∅ 24x102x410	F10 - F12 - F16 FL6 - FL7 - FL10 - FL12 FM7 - FM10 - FM12 - FH12 - FH16	20442796 1590946 947835
27	722098	Staffa balestra QUADRA c/dadi / <i>U-bolt c/w nuts</i>	∅ 24x102x210	FM9-FM10-FM12-FL6-FH12-FH16	3987325
28	722099	Staffa balestra QUADRA c/dadi / <i>U-bolt c/w nuts</i>	∅ 24x102x260	FM7 - FM9 - FM10 - FM12 - FH12 - FH16	20375242
29	722096	Staffa balestra SEMITONDA c/dadi / <i>U-bolt c/w nuts</i>	∅ 24x91x420	F10 - F12 - F16 - FL7 - FL10 - FL12 - FM7 FM9 - FM10 - FM12 - FH12 - FH16	20442795 1628108
30	730429	Tassello distanziale per foglia balestra / <i>Spring buffer</i>		FM7 - FM9 - FM10 - FM12 - FH12 - FH16	1626139
31	730057	Tassello elastico per balestra / <i>Spring core</i>		F7 - FL7 - F10 - FL10 FH12 - F16 - FH16 N10 - NL10	1629553 1609657 20390836
32	712856	Tirante completo barra stabilizzatrice posteriore <i>Stabilizer bar rod, rear</i>	L= 435 mm	FM7 - FM9 - FM12 - FH12 - FH16 FH - FM	20443061 20443065 20994418
33	712538	Tirante completo barra stabilizzatrice <i>Stabilizer bar rod</i>	L= 437 mm	FM7 - FM12 - FH12	3173613 3987354
34	712539	Tirante completo barra stabilizzatrice, post. <i>Stabilizer bar rod, rear</i>	L= 380 mm	FH - FH12 - FH16 FM - FM9 - FM12	20443062 20443066 20994419 21248088
35	712854	Tirante completo barra stabilizzatrice posteriore <i>Stabilizer bar rod, rear</i>	L=350 mm	FH12 - FH16 - FM - FH	20443063 20443067 20539988 20994420

**SOSPENSIONE
SUSPENSION**

BILANCIERE / EQUALIZER ASSY

1



2

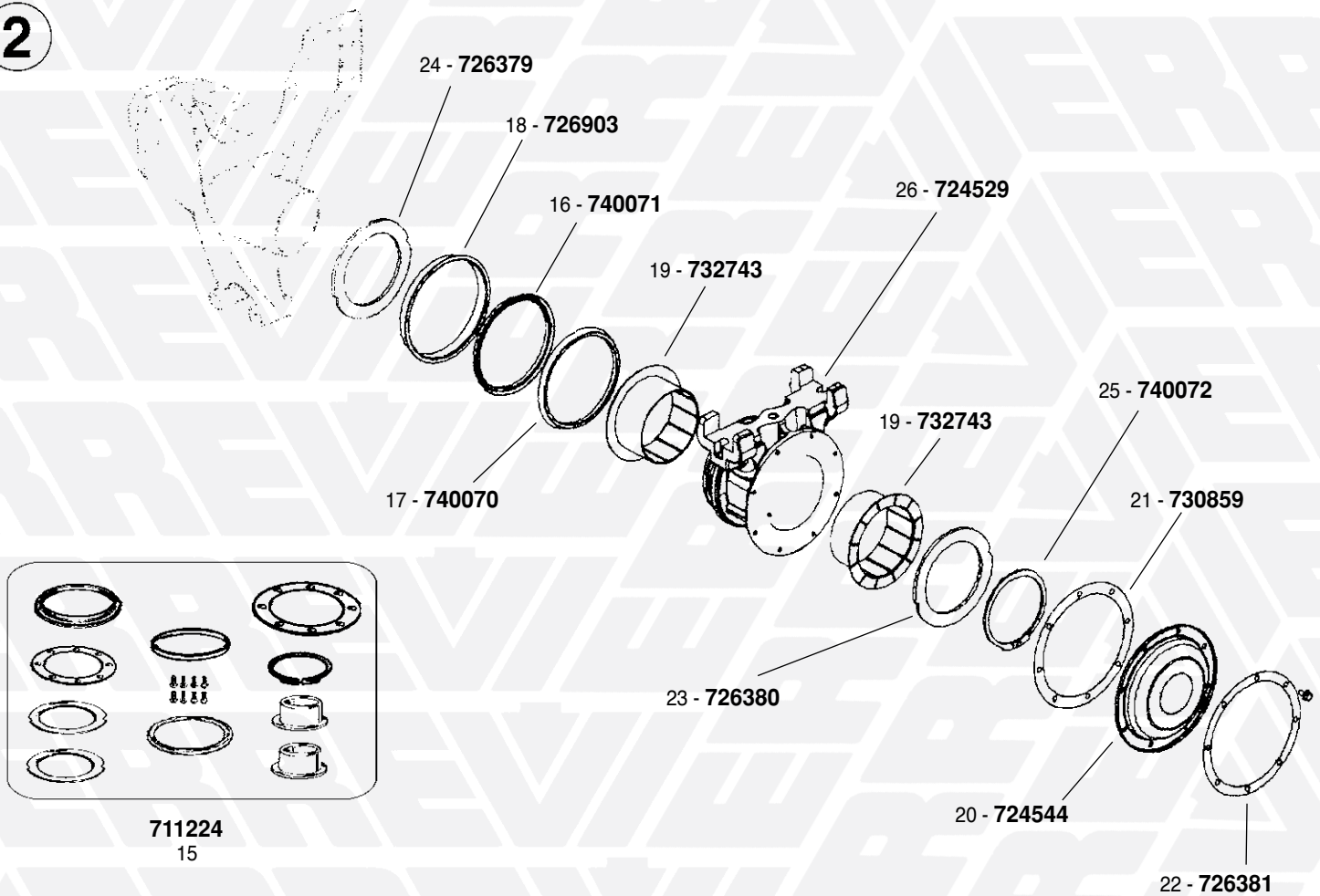
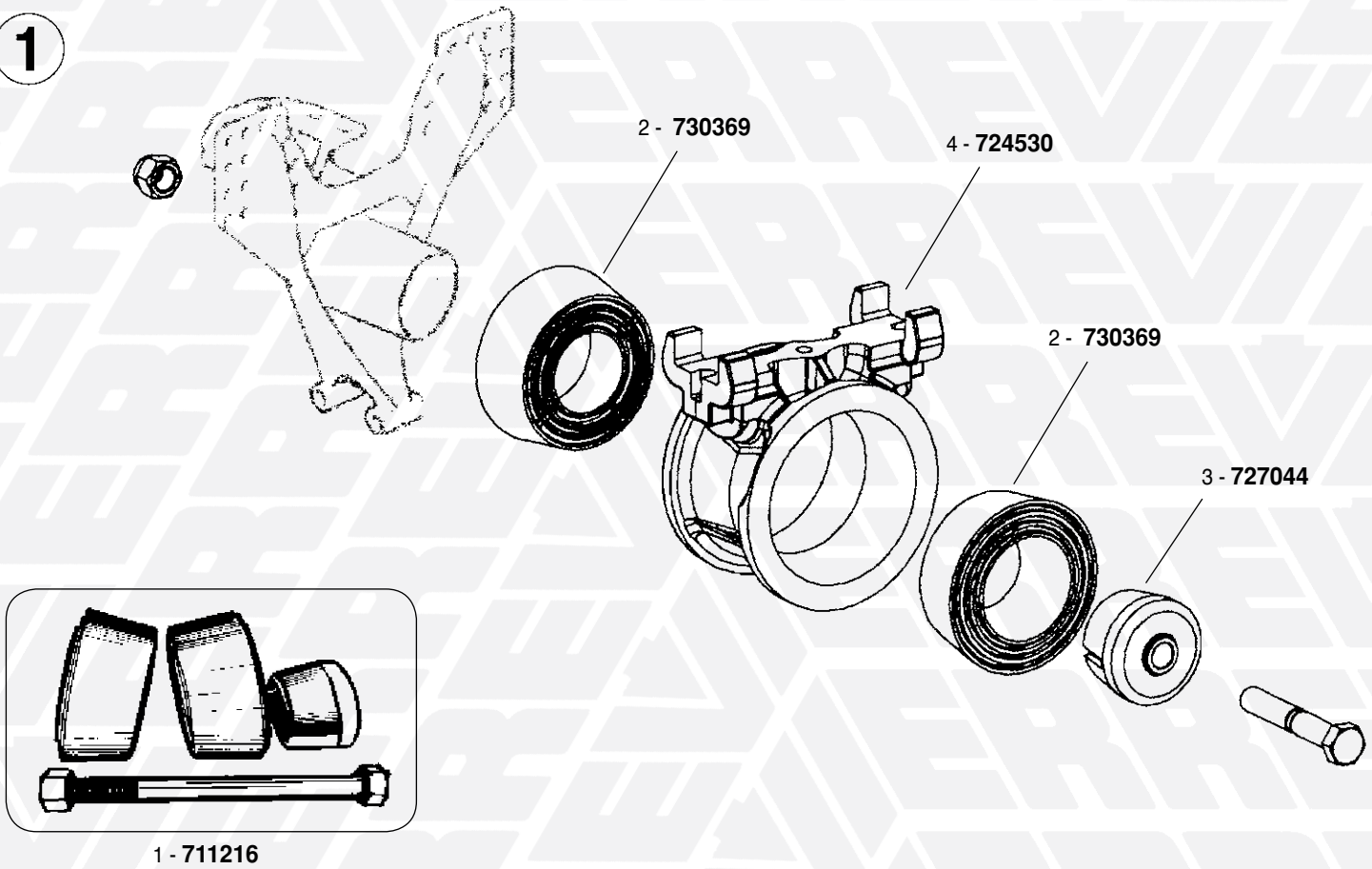


FIG. ITEM	RIF. ERREVI ERREVI REF.	DESCRIZIONE PARTICOLARI DESCRIPTION	TIPO VEHICLE MODEL	RIF. ORIG. ORIG. REF.
BILANCIERE / EQUALIZER ASSY				
①				
1	711217	Serie completa revisione bilanciante (1 sola PARTE) <i>Equalizer repair kit (SINGLE)</i>	F10 - F12 - F16 - N10 - N12 - NL10 NL12 - FM9 - FM12 - FH12 - FH16 - FL7	1590885S
2	740071	Anello di tenuta interno / <i>Seal ring</i>	∅ 163x177x11 F10 - F12 - F16 - N10 - N12 - NL10 NL12 - FM9 - FM12 - FH12 - FH16 - FL7	1593522
3	740070	Anello di tenuta interno / <i>Seal ring</i>	∅ 160x183x11 F10 - F12 - F16 - N10 - N12 - NL10 NL12 - FM9 - FM12 - FH12 - FH16 - FL7	1586520
4	726903	Anello di tenuta interno / <i>Wear ring</i>	∅ 177x180x20 F10 - F12 - F16 - N10 - N12 - NL10 NL12 - FM9 - FM12 - FH12 - FH16 - FL7	1586518
5	726904	Anello di protezione / <i>Seal ring</i>	∅ 181,5x212x12 F10 - F12 - F16 N10 - N12 - NL10 - NL12 FM9 - FM12 - FH12 - FH16 - FL7	1586521
6	732742	Boccola supporto bilanciante / <i>Bush</i>	∅ 129x134x81,5 F10 - F12 - F16 - N10 - N12 - NL10 NL12 - FM9 - FM12 - FH12 - FH16 - FL7	1581543
7	726096	Boccola supporto bilanciante / <i>Bush</i>	∅ 130x135x80 F10 - F12 - F16 - N10 - N12 - NL10 NL12 - FM9 - FM12 - FH12 - FH16 - FL7	1590885
8	724544	Coperchio per supporto centrale bilanciante / <i>Trunnion cover</i>	F10 - F12 - F16 - N10 - N12 - NL10 NL12 - FM9 - FM12 - FH12 - FH16 - FL7	1502292
9	730859	Guarnizione per coperchio / <i>Gasket</i>	F10 - F12 - F16 - N10 - N12 - NL10 NL12 - FM9 - FM12 - FH12 - FH16 - FL7	1620742
10	726381	Rondella esterna supporto centrale bilanciante / <i>Thrust washer</i>	F10 - F12 - F16 - N10 - N12 - NL10 NL12 - FM9 - FM12 - FH12 - FH16 - FL7	1590508
11	726380	Rondella esterna supporto centrale bilanciante / <i>Thrust washer</i>	F10 - F12 - F16 - N10 - N12 - NL10 NL12 - FM9 - FM12 - FH12 - FH16 - FL7	1590064
12	726379	Rondella interna supporto centrale bilanciante / <i>Thrust washer</i>	F10 - F12 - F16 - N10 - N12 - NL10 NL12 - FM9 - FM12 - FH12 - FH16 - FL7	1509219
13	740072	Seeger / <i>Ciclip</i>	F10 - F12 - F16 - N10 - N12 - NL10 NL12 - FM9 - FM12 - FH12 - FH16 - FL7	951082
14	724537	Supporto centrale bilanciante / <i>Trunnion</i>	F10 - F12 - F16 - N10 - N12 - NL10 NL12 - FM9 - FM12 - FH12 - FH16 - FL7	1593470 3197937 3197938 8156726 8157796
②				
15	711224	Serie completa revisione bilanciante (1 sola PARTE) <i>Equalizer repair kit (SINGLE)</i>	FM12 - FH16	3198095S
16	740071	Anello di tenuta interno / <i>Seal ring</i>	∅ 163x177x11 F10 - F12 - F16 - N10 - N12 - NL10 NL12 - FM9 - FM12 - FH12 - FH16 - FL7	1593522
17	740070	Anello di tenuta interno / <i>Seal ring</i>	∅ 160x183x11 F10 - F12 - F16 - N10 - N12 - NL10 NL12 - FM9 - FM12 - FH12 - FH16 - FL7	1586520
18	726903	Anello di tenuta interno / <i>Wear ring</i>	∅ 177x180x20 F10 - F12 - F16 - N10 - N12 - NL10 NL12 - FM9 - FM12 - FH12 - FH16 - FL7	1586518
19	732743	Boccola supporto bilanciante / <i>Bush</i>	∅ 129x134x67 FM12 - FH16	1620443
20	724544	Coperchio per supporto centrale bilanciante / <i>Trunnion cover</i>	F10 - F12 - F16 - N10 - N12 - NL10 NL12 - FM9 - FM12 - FH12 - FH16 - FL7	1502292
21	730859	Guarnizione per coperchio / <i>Gasket</i>	F10 - F12 - F16 - N10 - N12 - NL10 NL12 - FM9 - FM12 - FH12 - FH16 - FL7	1620742
22	726381	Rondella esterna supporto centrale bilanciante / <i>Thrust washer</i>	F10 - F12 - F16 - N10 - N12 - NL10 NL12 - FM9 - FM12 - FH12 - FH16 - FL7	1590508
23	726380	Rondella esterna supporto centrale bilanciante / <i>Thrust washer</i>	F10 - F12 - F16 - N10 - N12 - NL10 NL12 - FM9 - FM12 - FH12 - FH16 - FL7	1590064
24	726379	Rondella interna supporto centrale bilanciante / <i>Thrust washer</i>	F10 - F12 - F16 - N10 - N12 - NL10 NL12 - FM9 - FM12 - FH12 - FH16 - FL7	1509219
25	740072	Seeger / <i>Ciclip</i>	F10 - F12 - F16 - N10 - N12 - NL10 NL12 - FM9 - FM12 - FH12 - FH16 - FL7	951082
26	724529	Supporto centrale bilanciante / <i>Trunnion</i>	FM12 - FH16	3198095 8060233

BILANCIERE / EQUALIZER ASSY

1



2

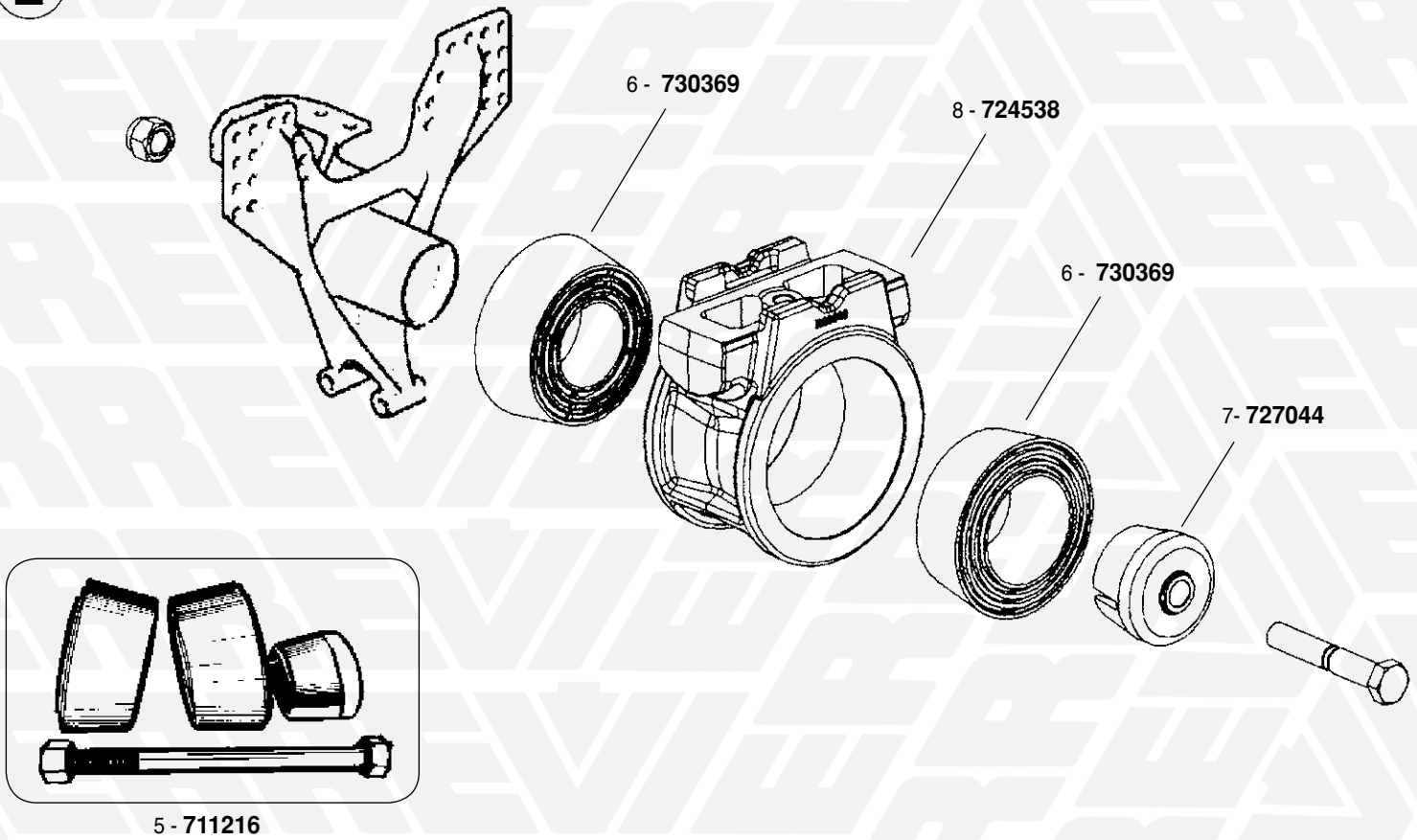


FIG. ITEM	RIF. ERREVI ERREVI REF.	DESCRIZIONE PARTICOLARI DESCRIPTION	TIPO VEHICLE MODEL	RIF. ORIG. ORIG. REF.
BILANCIERE / EQUALIZER ASSY				
①				
1	711216	Serie completa revisione bilanciante (1 sola PARTE) Equalizer repair kit (SINGLE)	FM9 - FM12 - FH12 - FH16 FH - FM	21363702S 21178062S
2	730369	Boccola elastica per supporto bilanciante / <i>Stabilizer bush</i>		20442252
3	727044	Boccola conica / <i>Conical bush</i>	ø 25x105x67 FM9 - FM12 - FH12 - FH16 FH - FM	21363702 21178062 20466804
4	724530	Supporto centrale bilanciante / <i>Trunnion</i>	FM9 - FM12	20429274
②				
5	711216	Serie completa revisione bilanciante (1 sola PARTE) Equalizer repair kit (SINGLE)	FM9 - FM12 - FH12 - FH16 FH - FM	21363702S 21178062S
6	730369	Boccola elastica per supporto bilanciante / <i>Stabilizer bush</i>		20442252
7	727044	Boccola conica / <i>Conical bush</i>	ø 25x105x67 FM9 - FM12 - FH12 - FH16 FH - FM	21363702 21178062
8	724538	Supporto centrale bilanciante / <i>Trunnion</i>		20522482 21087257