

# STERZO / STEERING GEAR

## RICAMBI PER / SPARE PARTS FOR

### Barre accoppiamento/ *Track rods*

|         |      |           |
|---------|------|-----------|
| ASTRA   | pag. | 192       |
| DAF     | pag. | 192       |
| IVECO   | pag. | 192 - 193 |
| MAN     | pag. | 193       |
| RENAULT | pag. | 193       |
| SCANIA  | pag. | 193       |
| VOLVO   | pag. | 193       |

### Tiranti longitudinali / *Drag links*

|          |      |           |
|----------|------|-----------|
| ASTRA    | pag. | 194 - 195 |
| DAF      | pag. | 194 - 195 |
| FIAT     | pag. | 194 - 195 |
| IVECO    | pag. | 196 - 199 |
| MAN      | pag. | 200 - 201 |
| MERCEDES | pag. | 200 - 203 |
| NISSAN   | pag. | 202 - 203 |
| RENAULT  | pag. | 202 - 203 |
| SCANIA   | pag. | 204 - 205 |
| VOLVO    | pag. | 204 - 205 |

### Teste per tiranti sterzo e barre accoppiamento/ *Tie-rod ends*

|            |      |           |
|------------|------|-----------|
| ASTRA      | pag. | 206       |
| DAF        | pag. | 206       |
| FIAT-IVECO | pag. | 207       |
| IVECO      | pag. | 208       |
| MAN        | pag. | 208 - 209 |
| MERCEDES   | pag. | 209       |
| NISSAN     | pag. | 210       |
| RENAULT    | pag. | 210       |
| SCANIA     | pag. | 210       |
| VOLVO      | pag. | 211       |

### Teste per servosterzo/ *Power-steering ball-joints*

|          |      |           |
|----------|------|-----------|
| DAF      | pag. | 212 - 213 |
| IVECO    | pag. | 212 - 213 |
| MAN      | pag. | 212 - 213 |
| MERCEDES | pag. | 212 - 213 |
| RENAULT  | pag. | 212 - 213 |
| SCANIA   | pag. | 212 - 213 |
| VOLVO    | pag. | 212 - 213 |

### Rinvio sterzo/ *Steering pin and kit*

|        |      |           |
|--------|------|-----------|
| SCANIA | pag. | 212 - 213 |
|--------|------|-----------|

### Servosterzo / *Power-steering*

#### Pompa di comando / *Pump 4522089*

|            |      |           |
|------------|------|-----------|
| FIAT-IVECO | pag. | 212 - 213 |
|------------|------|-----------|

### Alberi piantone sterzo / *Steering shaft assemblies*

#### Giuntini piantone sterzo / *Steering journals*

#### Boccole rinvio sterzo / *Steering bushes*

#### Cuffie per sterzo / *Steering boots*

|            |      |           |
|------------|------|-----------|
| FIAT-IVECO | pag. | 214 - 215 |
|------------|------|-----------|

| FIG. ITEM   | RIF. ERREVI ERREVI REF. | DESCRIZIONE PARTICOLARI DESCRIPTION                                       | TIPO VEHICLE MODEL | RIF. ORIG. ORIG. REF.   |
|---|-------------------------|---|--------------------|---|
| <b>BARRE ACCOPPIAMENTO / TRACK RODS</b>   |                         |   |                    |   |
| <span style="margin-left: 150px;">A</span> <span style="margin-left: 150px;">B</span> |                         |   |                    |   |
| <b>1 ASTRA</b>  |                         |   |                    |   |
| A   | <b>712120</b>           | Barra accoppiamento completa di teste / <i>Track rod, complete</i>        | tubo/tube mm. 1480 | HD7 - HD8 (4x2 - 6x4 - 8x4)<br>165171   |
| <b>2 DAF</b>  |                         |   |                    |   |
| B   | <b>712123</b>           | Barra accoppiamento completa di teste / <i>Track rod, complete</i>        | L=1600 mm          | CF75 - CF85 - XF95 - XF105<br>75CF - 85CF - 95XF<br>1286343<br>1353396  |
| A   | <b>712124</b>           | Barra accoppiamento completa di teste / <i>Track rod, complete</i>        | tubo/tube mm. 1590 | CF65 - CF75 - CF85 - XF95 - XF105<br>65CF - 75CF - 85CF - 95XF<br>1270853<br>1353391  |
| <b>3 IVECO</b>  |                         |   |                    |   |
| A   | <b>712098</b>           | Barra accoppiamento ruote NUDA<br><i>Track rod, bare</i>                  | tubo/tube mm. 1565 | 160.26 - 170NC35<br>170/190F26/ F35/ F35 HIDRO<br>180.24/ .26 - 190i26/ i35 - 190.30/ .38<br>190.33/ .36/ .42/ .48 - 220.36PT/ .38PT<br>240.26/ .30P/ .36/ .38P/ .48<br>260.36/ .38/ .48<br>4714576 |
| A   | <b>712099</b>           | Barra accoppiamento ruote completa di teste<br><i>Track rod, complete</i> | tubo/tube mm. 1565 | 160.26 - 170NC35<br>170/190F26/ F35/ F35 HIDRO<br>180.24/ .26 - 190i26/ i35<br>190.30/ .38 - 190.33/ .36/ .42/ .48<br>220.36PT/ .38PT<br>240.26/ .30P/ .36/ .38P/ .48<br>260.36/ .38/ .48<br>-      |
| A   | <b>712107</b>           | Barra accoppiamento ruote NUDA<br><i>Track rod, bare</i>                  | tubo/tube mm. 1565 | 160.26 - 170NC35<br>170/190F26/ F35/ F35 HIDRO<br>180.24/ .26 - 190i26/ i35 - 190.30/ .38<br>190.33/ .36/ .42/ .48 - 220.36PT/ .38PT<br>240.26/ .30P/ .36/ .38P/ .48<br>260.36/ .38/ .48<br>4835068 |
| A   | <b>712108</b>           | Barra accoppiamento ruote completa di teste<br><i>Track rod, complete</i> | tubo/tube mm. 1565 | 160.26 - 170NC35<br>170/190F26/ F35/ F35 HIDRO<br>180.24/ .26 - 190i26/ i35<br>190.30/ .38 - 190.33/ .36/ .42/ .48<br>220.36PT/ .38PT<br>240.26/ .30P/ .36/ .38P/ .48<br>260.36/ .38/ .48<br>-      |
| A   | <b>712121</b>           | Barra accoppiamento completa di teste / <i>Track rod, complete</i>        | tubo/tube mm. 1475 | <b>EUROCARGO</b> 170E15/E18/E23/<br>E27 - 260E23KE/E27KE<br><b>EUROCARGO "TECTOR"</b><br>180E21/E24/E28 - 260E28KE<br>98470968<br>4844041   |
| A   | <b>712111</b>           | Barra accoppiamento ruote NUDA<br><i>Track rod, bare</i>                  | tubo/tube mm. 1495 | <b>EUROCARGO</b> 120E15/E18/E23<br>130E15/E18/E23 - 150E15/E18/E23/<br>E27 - 260E23 280E23 - 320E27<br><b>EUROCARGO "TECTOR"</b> 130E18/<br>E24/E28 - 150E18/E24/E28 - 320E28T<br>-                 |
| A   | <b>712112</b>           | Barra accoppiamento ruote completa di teste<br><i>Track rod, complete</i> | tubo/tube mm. 1495 | <b>EUROCARGO</b> 120E15/E18/E23<br>130E15/E18/E23 - 150E15/E18/E23/<br>E27 - 260E23 - 280E23 - 320E27<br><b>EUROCARGO "TECTOR"</b> 130E18/<br>E24/E28 - 150E18/E24/E28 - 320E28T<br>4854871         |
| A   | <b>712116</b>           | Barra accoppiamento ruote completa di teste<br><i>Track rod, complete</i> | tubo/tube mm. 1400 | <b>EUROCARGO</b><br><b>EUROCARGO "TECTOR"</b> 75E13/<br>E15/E17/E18 - 100E17/E18/E21<br>98402553<br>500307556   |
| A   | <b>712126</b>           | Barra di accoppiamento completa di teste<br><i>Track rod, complete</i>    | L=1480 mm          | <b>EUROCARGO</b><br>41005309<br>41005460<br>8165309   |

| FIG. ITEM | RIF. ERREVI ERREVI REF. | DESCRIZIONE PARTICOLARI DESCRIPTION | TIPO VEHICLE MODEL | RIF. ORIG. ORIG. REF. |
|-----------|-------------------------|-------------------------------------|--------------------|-----------------------|
|-----------|-------------------------|-------------------------------------|--------------------|-----------------------|

**A**

**B**

## 1 IVECO

|   |               |  |                    |   |   |
|---|---------------|--|--------------------|---|---|
| A | <b>712122</b> | Barra accoppiamento completa di teste / <i>Track rod, complete</i>       | tubo/tube mm. 1355 | <b>EUROTECH - EUROSTAR E.TECH "CURSOR" - E.STAR "CURSOR"</b>                                      | 41033237<br>41032608                                  |
| A | <b>712109</b> | Barra accoppiamento ruote NUDA / <i>Track rod, bare</i>                  | tubo/tube mm. 1520 | <b>EUROTECH - EUROTECH "CURSOR" EUROSTAR - EUROSTAR "CURSOR" EUROTRAKKER EUROTRAKKER "CURSOR"</b> | -   |
| A | <b>712110</b> | Barra accoppiamento ruote completa di teste / <i>Track rod, complete</i> | tubo/tube mm. 1520 | <b>EUROTECH - EUROTECH "CURSOR" EUROSTAR - EUROSTAR "CURSOR" EUROTRAKKER EUROTRAKKER "CURSOR"</b> | 8137594<br>8138182<br>8163773<br>41036943<br>42003432 |
| B | <b>712762</b> | Barra accoppiamento completa di teste / <i>Track rod</i>                 | L = 1430 mm        | <b>EUROTRAKKER 190E31/E37 - 380E42 EUROTRAKKER CURSOR 190E35/E38-260E44-340E48 380E38/E44</b>     | 42118694<br>42115532<br>42118782                      |
| A | <b>712126</b> | Barra di accoppiamento completa di teste / <i>Track rod, complete</i>    | L=1480 mm          | <b>EUROTRAKKER TRAKKER</b>  | 41005309<br>41005460<br>8165309                       |
| A | <b>712122</b> | Barra accoppiamento completa di teste / <i>Track rod, complete</i>       | tubo/tube mm. 1355 | <b>STRALIS</b>  | 41033237<br>41032608                                  |
| A | <b>712109</b> | Barra accoppiamento ruote NUDA / <i>Track rod, bare</i>                  | tubo/tube mm. 1520 | <b>STRALIS 260S40/S43/S44/S48/S54 440S40/S43/S44/S48/S54</b>                                      | -   |
| A | <b>712110</b> | Barra accoppiamento ruote completa di teste / <i>Track rod, complete</i> | tubo/tube mm. 1520 | <b>STRALIS 260S40/S43/S44/S48/S54 440S40/S43/S44/S48/S54</b>                                      | 8137594<br>8138182<br>8163773<br>41036943<br>42003432 |

## 2 MAN

|   |               |  |             |                                |   |
|---|---------------|--|-------------|--------------------------------|---|
| B | <b>712125</b> | Barra accoppiamento / <i>Track rod</i> | L = 1610 mm | M2000<br>TGA - TGM - TGS - TGX | 81467116859<br>81467116921<br>81467116861<br>81467116860<br>81467116883 |
|---|---------------|--|-------------|--------------------------------|---|

## 3 RENAULT

|   |               |  |             |  |  |
|---|---------------|--|-------------|--|--|
| B | <b>712765</b> | Barra accoppiamento completa di teste / <i>Track rod</i> | L = 1655 mm | MAGNUM DXI<br>PREMIUM<br>MIDLUM<br>KERAX | 5001868363<br>5001868363<br>5010600822<br>7421560957 |
|---|---------------|--|-------------|--|--|

## 4 SCANIA

|   |               |  |                    |                            |   |
|---|---------------|--|--------------------|----------------------------|---|
| A | <b>712113</b> | Barra accoppiamento ruote NUDA / <i>Track rod, bare</i>                  | tubo/tube mm. 1630 | R142 - R143                | 395432-8  |
| A | <b>712114</b> | Barra accoppiamento ruote completa di teste / <i>Track rod, complete</i> | tubo/tube mm. 1630 | R142 - R143                | 395350-2  |
| B | <b>712761</b> | Barra accoppiamento completa di teste / <i>Track rod</i>                 | L = 1685 mm        | Serie P - G - R - T Series | 1897336<br>1723896<br>1737684<br>1527989<br>1527978 |

## 5 VOLVO

|   |               |  |             |    |          |
|---|---------------|--|-------------|----|----------|
| B | <b>712765</b> | Barra accoppiamento completa di teste / <i>Track rod</i> | L = 1655 mm | FE | 25372885 |
|---|---------------|--|-------------|----|----------|

I marchi ed i nominativi dei costruttori come pure i riferimenti originali sono esposti a solo titolo indicativo in quanto i nostri particolari non sono originali  
 Manufacturer's names and part numbers in this catalogue are used for cross reference purposes only and do not imply anything about the origin or manufacturer of product.

1

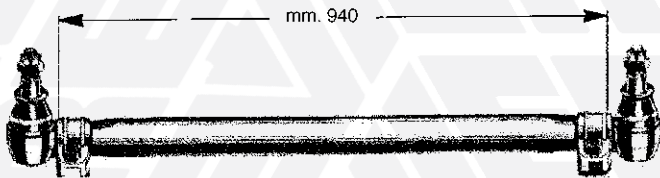

1 - 712729

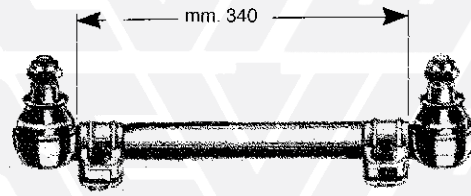

2 - 712730

2

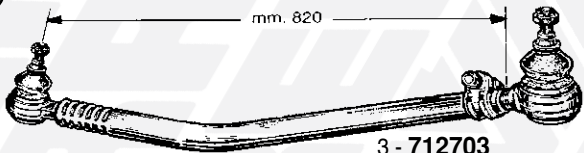

3 - 712703

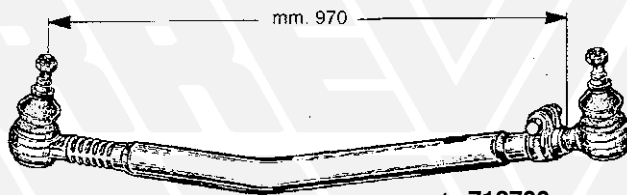

4 - 712700

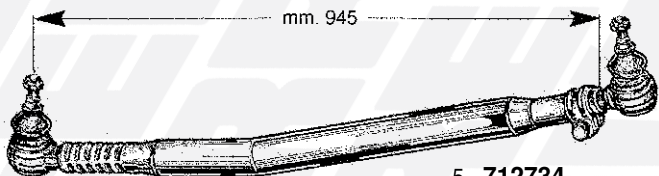

5 - 712734



6 - 712735

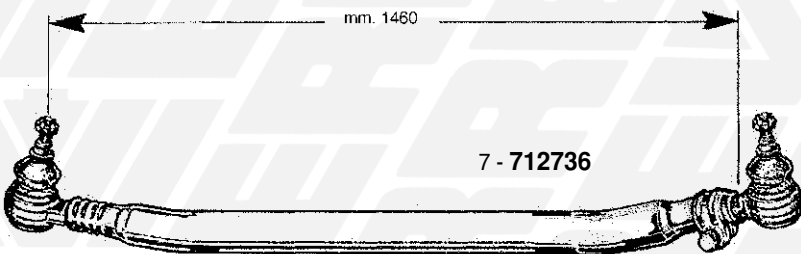

7 - 712736

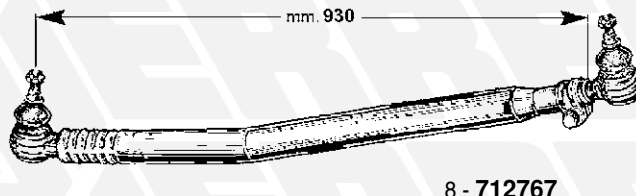

8 - 712767

3

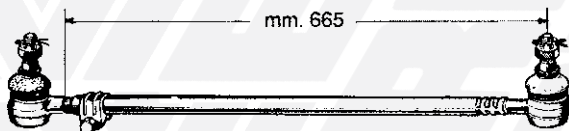

9 - 712680

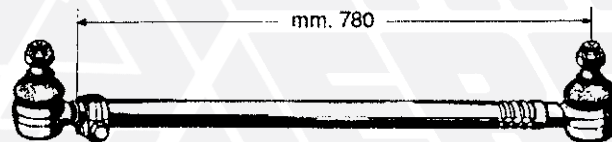

10 - 712677

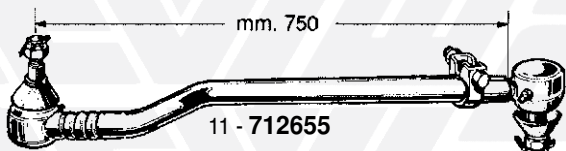

11 - 712655

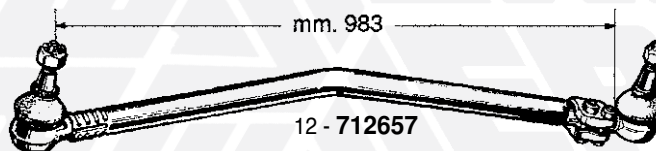

12 - 712657

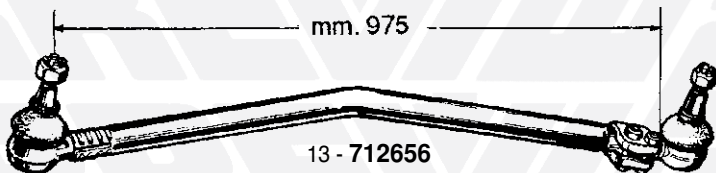

13 - 712656

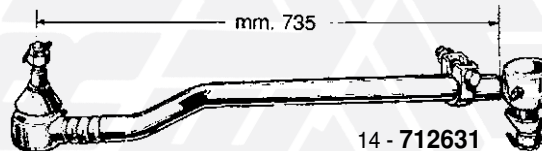

14 - 712631

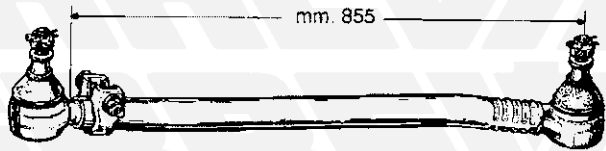

15 - 712640

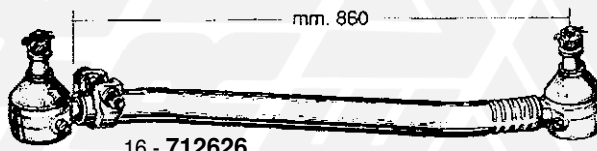

16 - 712626

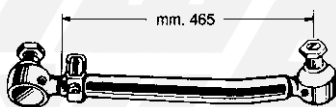

17 - 712602

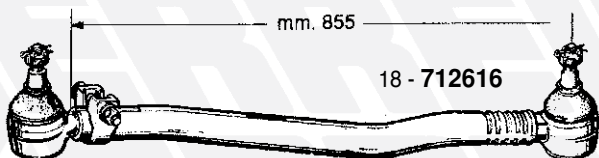

18 - 712616

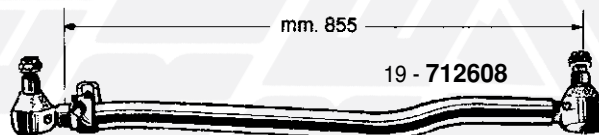

19 - 712608

| FIG. ITEM                                 | RIF. ERREVI ERREVI REF. | DESCRIZIONE PARTICOLARI DESCRIPTION   | TIPO VEHICLE MODEL   | RIF. ORIG. ORIG. REF.         |
|---|-------------------------|---|--|-------------------------------|
| <b>TIRANTI LONGITUDINALI / DRAG LINKS</b> |                         |   |  |                               |
| <b>① ASTRA</b>                            |                         |   |  |                               |
| 1   | <b>712729</b>           | Tirante longitudinale completo / <i>Drag link</i>   | <b>L tubo = 940 mm</b> HD7<br>HD8 (4x2 - 6x4 - 8x4)                            | 165163                        |
| 2   | <b>712730</b>           | Tirante longitudinale completo / <i>Drag link</i>   | <b>L tubo = 340 mm</b> HD8 (8x4)   | 180649                        |
| <b>② DAF</b>                              |                         |   |  |                               |
| 3   | <b>712703</b>           | Tirante longitudinale completo / <i>Drag link</i>   | <b>L = 820 mm</b> F2300 - F2800 - F3300 - F3600                                | 94029                         |
| 4   | <b>712700</b>           | Tirante longitudinale completo / <i>Drag link</i>   | <b>L = 970 mm</b> 85FA - 85FT - 95FA - 95FT - 95XF                             | 94038                         |
| 5   | <b>712734</b>           | Tirante longitudinale completo / <i>Drag link</i>   | <b>L = 945 mm</b> XF95 - 95XF  | 1291060<br>1351734<br>1385499 |
| 6   | <b>712735</b>           | Tirante longitudinale completo / <i>Drag link</i>   | <b>L = 960 mm</b> 95XF   | 1291048<br>1351735<br>1385500 |
| 7   | <b>712736</b>           | Tirante longitudinale completo / <i>Drag link</i>   | <b>L = 1460 mm</b> CF75 - CF85<br>XF95 - XF105 - 95XF                          | 1297572<br>1361155            |
| 8   | <b>712767</b>           | Tirante longitudinale completo / <i>Drag link</i>   | <b>L = 930 mm</b> CF85 - XF95 - XF105  | 1395994                       |
| <b>③ FIAT</b>                             |                         |   |  |                               |
| 9   | <b>712680</b>           | Tirante completo / <i>Drag link</i>   | <b>L = 665 mm</b> 35NC/ 40NC/ 45NC/ 49NC<br>OM35 - OM40 - OM45 - OM50 U.T.     | 8557536                       |
| 10  | <b>712677</b>           | Tirante completo / <i>Drag link</i>   | <b>L = 780 mm</b> 65NC - 65NC/60 - 70NC - 75NC<br>OM65 - OM65/60 - OM70 - OM75 | 8558532<br>8558541            |
| 11  | <b>712655</b>           | Tirante completo-veicoli c/servosterzo<br><i>Drag link (power-steering)</i>                         | <b>L = 750 mm</b> 100NC - 110NC e derivati                                     | 4665209                       |
| 12  | <b>712657</b>           | Tirante completo-veicoli c/cabina ribaltabile<br><i>Drag link (tilting cab)</i>                     | <b>L = 983 mm</b> 100NC - 110PC<br>OM110 - OM110P                              | 61591070<br>61595957          |
| 13  | <b>712656</b>           | Tirante completo-veicoli c/cabina ribaltabile<br><i>Drag link (tilting cab)</i>                     | <b>L = 975 mm</b> 130NC/ NR/ NT - OM130/ R/ T                                  | 61590824<br>61595960          |
| 14  | <b>712631</b>           | Tirante completo G.S.-veicoli c/cabina fissa<br><i>Drag link LHD (fixed cab)</i>                    | <b>L = 735 mm</b> 673 - 130NC/ NR/ NT  | 4665501                       |
| 15  | <b>712640</b>           | Tirante completo G.S. / <i>Drag link LHD</i>  | <b>L = 855 mm</b> 684 e derivati - 160NC/ NT<br>OM160 - OM160T                 | 4666993<br>4733752            |
| 16  | <b>712626</b>           | Tirante completo / <i>Drag link</i>   | <b>L = 860 mm</b> 684 e derivati - 160 e derivati                              | 4666991<br>4733704            |
| 17  | <b>712602</b>           | Tirante completo assale ant. (testa registrabile)<br><i>Drag link, front axle (adjustable ends)</i> | <b>L = 465 mm</b> 690 - 691 - 180NC  | 4520694<br>4669091            |
| 18  | <b>712616</b>           | Tirante completo / <i>Drag link</i>   | <b>L = 855 mm</b> 619N1 - 697 - 300PC  | 4624032<br>4732546            |
| 19  | <b>712608</b>           | Tirante completo G.S. / <i>Drag link LHD</i>  | <b>L = 855 mm</b> 619N1 - 697 - 300PC  | 4667156<br>4732549            |

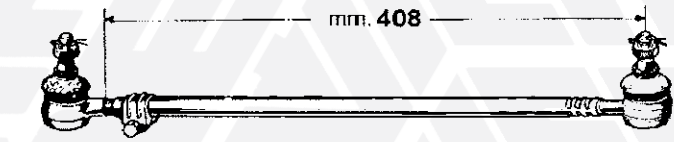

1 - 712969

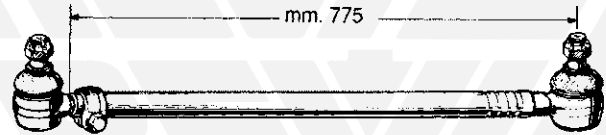

2 - 712632

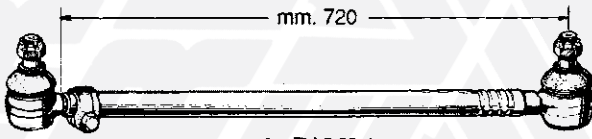

3 - 712671

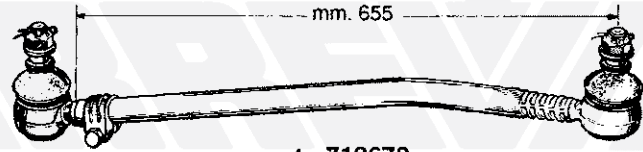

4 - 712678

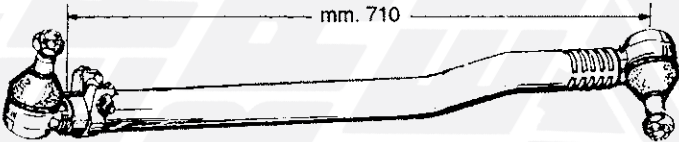

5 - 712670

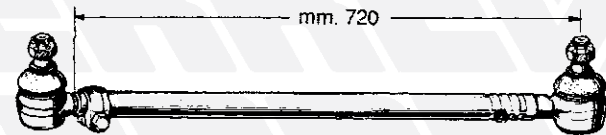

6 - 712671

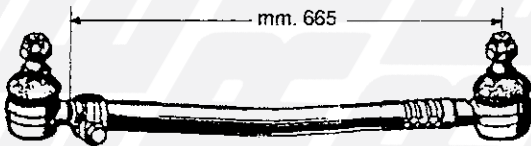

7 - 712672

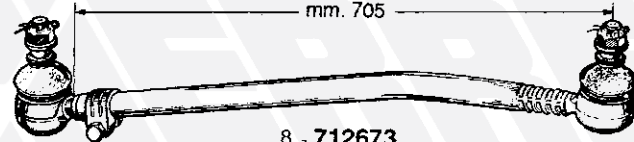

8 - 712673

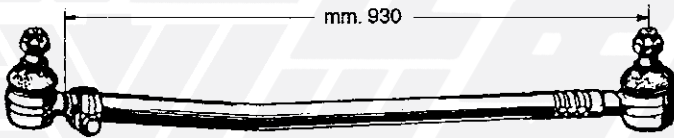

9 - 712674

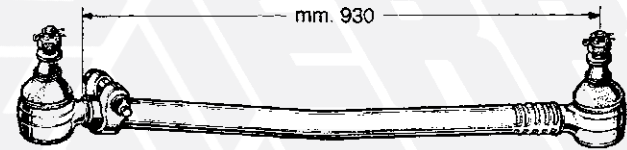

10 - 712675

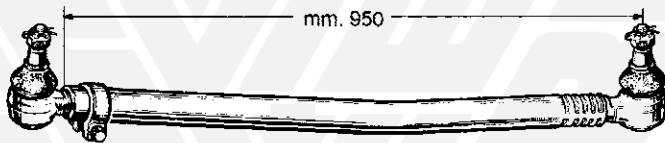

11 - 712681

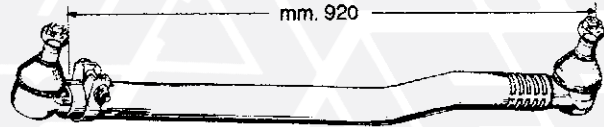

12 - 712634

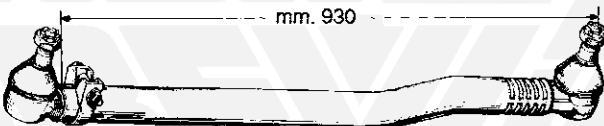

13 - 712639

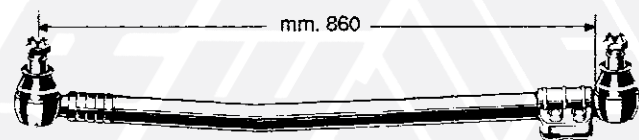

14 - 712679

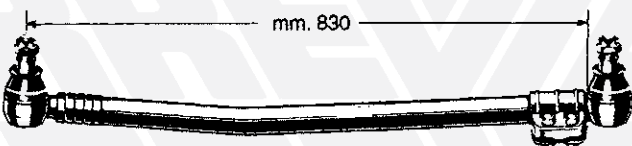

15 - 712638

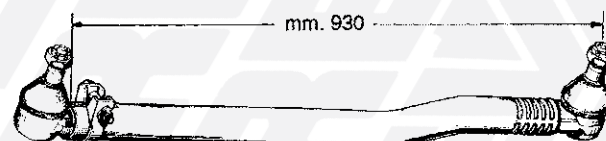

16 - 712639

| FIG. ITEM    | RIF. ERREVI ERREVI REF. | DESCRIZIONE PARTICOLARI DESCRIPTION  | TIPO VEHICLE MODEL  | RIF. ORIG. ORIG. REF. |
|--------------|-------------------------|--|---|-----------------------|
| <b>IVECO</b> |                         |  |   |                       |
| 1            | <b>712969</b>           | Tirante completo / <i>Drag link</i>  | <b>L = 408 mm</b> 30.8 - 35.8 - 40.8 DAILY DUTY   | 8582023               |
| 2            | <b>712632</b>           | Tirante completo / <i>Drag link</i>  | <b>L = 775 mm</b> 50NC - 55NC - 50.8/F8 - 50.9/F9<br>50.10/F10 - 50.9Z - 55.8/F8<br>55.9/F9 - 55.10/F10 - 60.8/F8<br>60.10/F10 - 60.11 TURBO Z<br>65.10/F10 - 70.10/F10 - 75.10/F10<br>80.13/F13 - 90.13/F13  | 8558522<br>8559559    |
| 3            | <b>712671</b>           | Tirante completo senza servosterzo (cabina ribaltabile)<br><i>Drag link w/o power-steering (tilting cab)</i>           | <b>L = 720 mm</b> 50.9Z - 60.11 TURBO Z<br>65.12 TURBO Z - 79.12 TURBO Z  | 8591219<br>8590443    |
| 4            | <b>712678</b>           | Tirante completo con servosterzo (cabina ribaltabile)<br><i>Drag link with power-steering (tilting cab)</i>            | <b>L = 655 mm</b> 50.9Z - 60.10/F10<br>60.11 TURBO Z - 75.10/F10<br>79.10/F10 - 79.12 TURBO Z<br>79.13/F13 - 79.14 - 79.14 Z<br>90.13/F13   | 8570528               |
| 5            | <b>712670</b>           | Tirante completo con servosterzo (cabina fissa)<br><i>Drag link with power-steering (fixed cab)</i>                    | <b>L = 710 mm</b> 50.10/F10 - 60.10/F10 - 65.10/F10<br>65.9Z - 90.13/F13  | 8567618               |
| 6            | <b>712671</b>           | Tirante completo con servosterzo (cabina ribaltabile)<br><i>Drag link with power-steering (tilting cab)</i>            | <b>L = 720 mm</b> 60.10/F10 - 75.10/F10 - 79.10/F10<br>79.13/F13 - 90.13/F13  | 8564248               |
| 7            | <b>712672</b>           | Tirante completo / <i>Drag link</i>  | <b>L = 665 mm</b> 95.14 - 95.14Z<br>109.14 (2ª Serie) - 109.14Z   | 8590435               |
| 8            | <b>712673</b>           | Tirante completo (2ª Serie) con servosterzo (cabina ribaltabile)<br><i>Drag link with power-steering (tilting cab)</i> | <b>L = 705 mm</b> 100.13/F13  | 8573757               |
| 9            | <b>712674</b>           | Tirante completo / <i>Drag link</i>  | <b>L = 930 mm</b> 115.14 - 115.17 - 135.14/ .17   | 4773359               |
| 10           | <b>712675</b>           | Tirante completo / <i>Drag link</i>  | <b>L = 930 mm</b> 145.17  | 4815933               |
| 11           | <b>712681</b>           | Tirante completo / <i>Drag link</i>  | <b>L = 950 mm</b> 165.24 - 175.17/ .24  | 4834041<br>4793166    |
| 12           | <b>712634</b>           | Tirante completo / <i>Drag link</i>  | <b>L = 920 mm</b> 160.26/ .26T - 170/190F26/ F35  | 4715615               |
| 13           | <b>712639</b>           | Tirante completo / <i>Drag link</i>  | <b>L = 930 mm</b> 180.24/ .26 - 190i26/ i35<br>190.30/ .38 (1ª Serie)<br>240.30P/ .38P  | 4747961<br>4747960    |
| 14           | <b>712679</b>           | Tirante completo / <i>Drag link</i>  | <b>L = 860 mm</b> 190.26H/ .30H<br>260.26H/ .30H/ .35H<br>330.26H/.35H - 330.30H (1ª Serie)<br>330.36 (1ª Serie)  | 42042950<br>42043912  |
| 15           | <b>712638</b>           | Tirante completo / <i>Drag link</i>  | <b>L = 830 mm</b> 330F26/ F35 - 330.30H (2ª Serie)<br>330.36 (2ª Serie)   | 42001326<br>42086458  |
| 16           | <b>712639</b>           | Tirante completo / <i>Drag link</i>  | <b>L = 930 mm</b> 190.26/ .26T U.T.<br>190.30/ .38 e deriv. U.T.<br>190.33/ .36/ .42/ .48 - 240.48<br><br><div style="text-align: center;"> <p>TURBOSTAR</p> </div> 190.24/ .26/ .30 - 240.26 - 260.32<br><br><div style="text-align: center;"> <p>TURBOTECH</p> </div> | 4747961<br>4747960    |

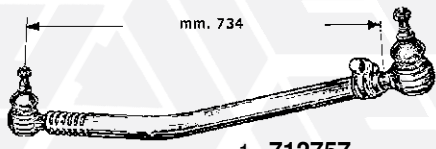

1 - 712757

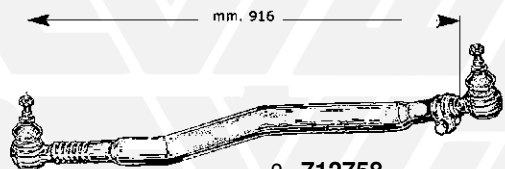

2 - 712758

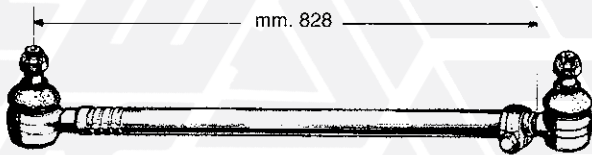

3 - 712937

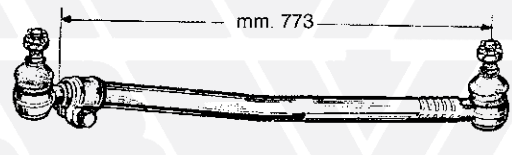

4 - 712900

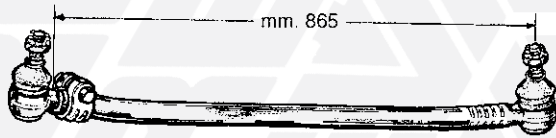

5 - 712901

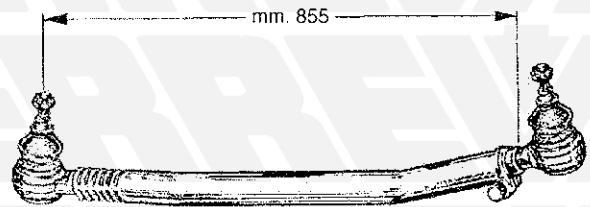

6 - 712731



7 - 712904

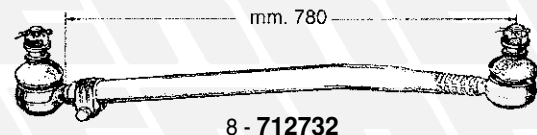

8 - 712732

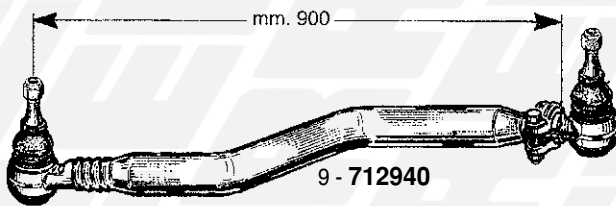

9 - 712940

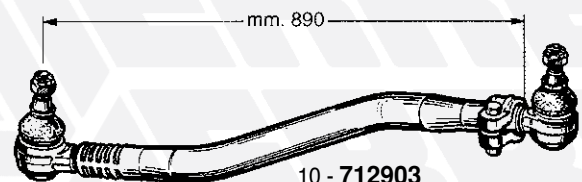

10 - 712903

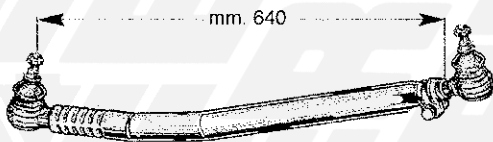

11 - 712733

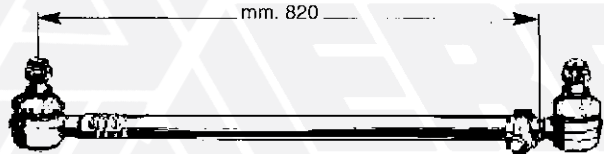

12 - 712932

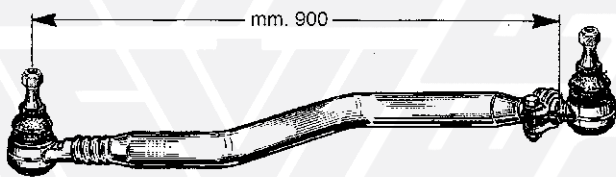

13 - 712931

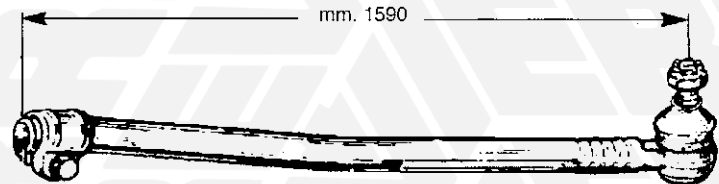

14 - 712933

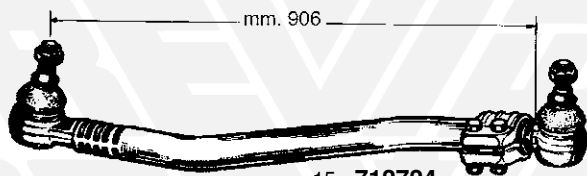

15 - 712724

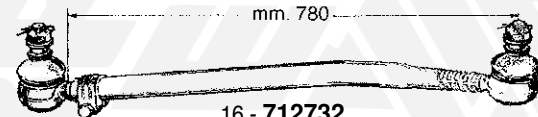

16 - 712732



17 - 712903

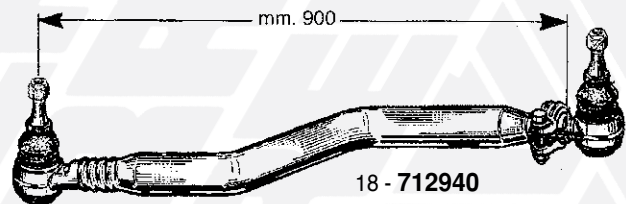

18 - 712940

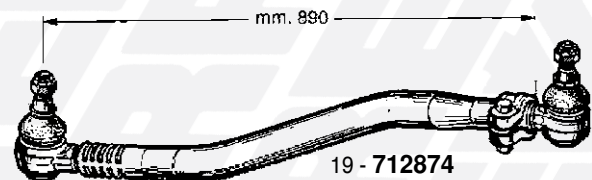

19 - 712874

**NEW**



| FIG. ITEM | RIF. ERREVI ERREVI REF. | DESCRIZIONE PARTICOLARI DESCRIPTION                          |             | TIPO VEHICLE MODEL  | RIF. ORIG. ORIG. REF.            |
|-----------|-------------------------|--|-------------|---|----------------------------------|
| 1         | 712757                  | Tirante longitudinale completo / Drag link                   | L = 734 mm  | <b>EUROCARGO</b><br>120E18/E21 - 120EL17/EL21   | 500324282                        |
| 2         | 712758                  | Tirante longitudinale completo / Drag link                   | L = 916 mm  | <b>EUROCARGO</b><br>95E15/E21 - 135E18/E23<br><b>EUROCARGO "TECTOR"</b><br>100E18/E21 - 140E18/E24 - 150E24   | 98473328                         |
| 3         | 712937                  | Tirante longitudinale completo / Drag link                   | L = 828 mm  | <b>EUROCARGO</b><br>80E21-90E21-100E21-120E24-170E23<br><b>EUROCARGO "TECTOR"</b><br>75E18 - 80E18/E21 - 90E18/E21<br>100E18/E21/E22 - 120E18/E24/<br>E25/E28 - 130E18/E24/E28<br>140E18/E21 - 260E28 - 320E28  | 98469650<br>98449025             |
| 4         | 712900                  | Tirante longitudinale completo / Drag link                   | L = 773 mm  | <b>EUROCARGO</b><br>60E10/E12/E14 - 65E10/E12/E14<br>75E10/E12/E14/E15 - 80E15/E18/<br>E21 - 100E15/E18/E21 - 180E21T<br><b>EUROCARGO "TECTOR"</b><br>75E13/E15/E17/E18 - 100E17/E18/E21  | 98402544<br>98467459             |
| 5         | 712901                  | Tirante longitudinale completo / Drag link                   | L = 865 mm  | <b>EUROCARGO</b><br>120E15/E18/E23 - 130E15/E18/<br>E23 - 150E15/E18/E23/E27R<br>260E23T - 280E23T - 320E27T<br><b>EUROCARGO "TECTOR"</b><br>130E18/E24/E28 - 150E18/E24/E28<br>320E28T   | 4854874                          |
| 6         | 712731                  | Tirante longitudinale completo / Drag link                   | L = 855 mm  | <b>EUROCARGO "TECTOR"</b><br>140E18 - 150E30 - 160E21/E22/<br>E24/E25/E28 - 180E22  | 504049893                        |
| 7         | 712904                  | Tirante longitudinale completo / Drag link                   | L = 855 mm  | <b>EUROTECH</b>   | 98446354                         |
| 8         | 712732                  | Tirante longitudinale completo / Drag link                   | L = 780 mm  | <b>EUROTECH</b><br>400E34/E38/E42<br><b>EUROSTAR</b><br>400E38/E42/E47  | 41016961<br>41017269<br>8135492  |
| 9         | 712940                  | Tirante longitudinale completo / Drag link                   | L = 900 mm  | <b>EUROTECH "CURSOR"</b><br>190E31/E35/E39<br><b>EUROSTAR "CURSOR"</b><br>190E39/E43  | 500397738                        |
| 10        | 712903                  | Tirante longitudinale completo / Drag link                   | L = 890 mm  | <b>EUROTECH - EUROSTAR</b><br><b>EUROTRAKKER</b><br><b>EUROTECH "CURSOR"</b><br><b>EUROSTAR "CURSOR"</b><br><b>EUROTRAKKER "CURSOR"</b>   | 41005463<br>8131582              |
| 11        | 712733                  | Tirante longitudinale completo / Drag link                   | L = 640 mm  | <b>EUROTRAKKER</b><br>410E42  | 41016964<br>41005466<br>41017272 |
| 12        | 712932                  | Tirante longitudinale completo / Drag link                   | L = 820 mm  | 340E34/E37/E42 } <b>EUROTRAKKER</b><br>410E37/E42 } <b>EUROTRAKKER</b><br>340E35/E38/E44 } <b>"CURSOR"</b><br>410E35/E38/E44/E48 }  | 41028269                         |
| 13        | 712931                  | Tirante longitudinale completo / Drag link                   | L = 900 mm  | 190E30/E31/E34/E37/E42 } <b>EUROTRAKKER</b><br>260E34/E37/E42 } <b>EUROTRAKKER</b><br>330E34/E37 } <b>EUROTRAKKER</b><br>400E31/E37/E42 } <b>EUROTRAKKER</b><br>410E42 } <b>EUROTRAKKER</b><br>180E24-190E31/E35 } <b>"CURSOR"</b><br>380E35-410E42 } | 41005475<br>41006093             |
| 14        | 712933                  | Tirante collegamento 1°-2° asse -SENZA FORCELLA- / Drag link | L = 1590 mm | 340E34/E37/E42 } <b>EUROTRAKKER</b><br>410E37/E42 } <b>EUROTRAKKER</b><br>340E35/E38/E44 } <b>"CURSOR"</b><br>410E35/E38/E44/E48 }  | 41032826                         |
| 15        | 712724                  | Tirante longitudinale completo / Drag link                   | L = 906 mm  | <b>EUROTRAKKER "CURSOR"</b>   | 41215165                         |
| 16        | 712732                  | Tirante longitudinale completo / Drag link                   | L = 780 mm  | <b>STRALIS</b><br>400S40/S43/S48/S54  | 41016961<br>41017269             |
| 17        | 712903                  | Tirante completo / Drag link                                 | L = 890 mm  | <b>STRALIS</b>  | 41005463                         |
| 18        | 712940                  | Tirante longitudinale completo / Drag link                   | L = 900 mm  | <b>STRALIS</b>  | 500397738                        |
| 19        | 712874                  | Tirante longitudinale completo / Drag link                   | L = 890 mm  | <b>EUROSTAR</b><br><b>EUROTECH</b><br><b>EUROTRAKKER</b><br><b>STRALIS</b><br><b>TRAKKER</b>  | 5801282537<br>5801282538         |

**STERZO  
STEERING**

1

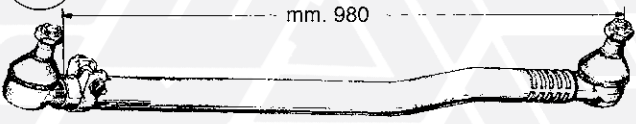

712938  
1

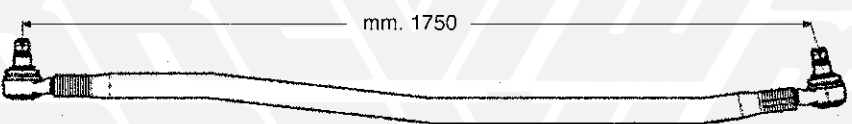

712939  
2

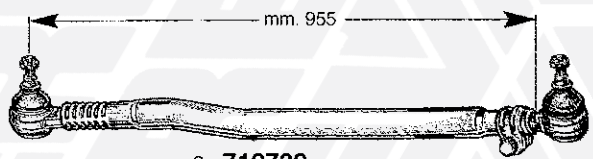

3 - 712739

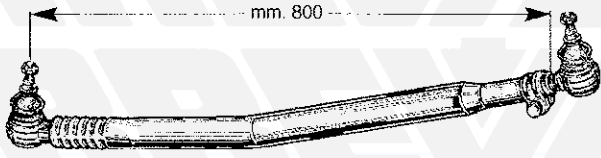

4 - 712740

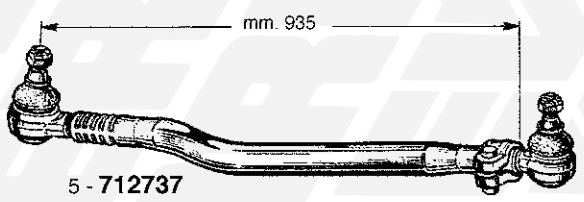

5 - 712737

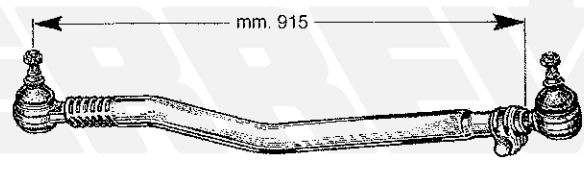

6 - 712738

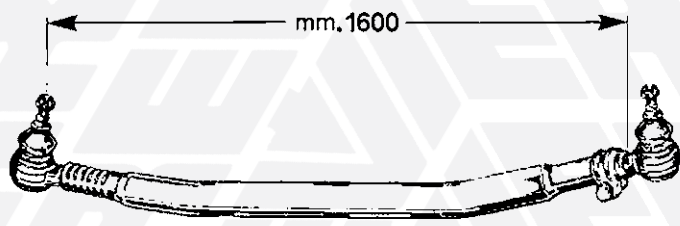

7 - 712760

2

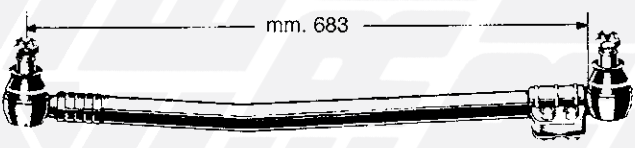

8 - 712707

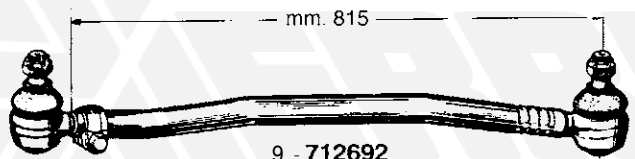

9 - 712692

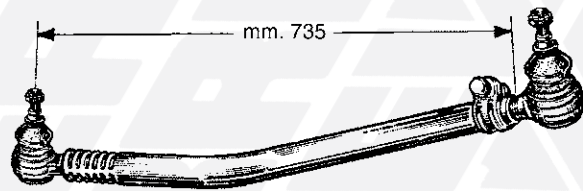

10 - 712908



11 - 712909

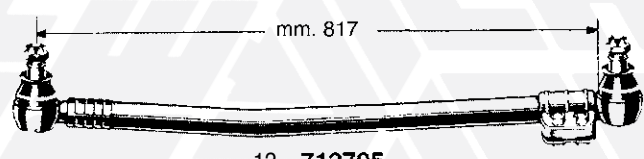

12 - 712705

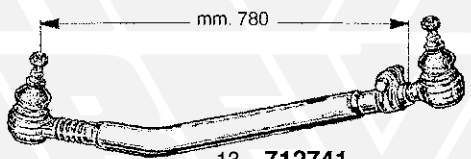

13 - 712741



14 - 712764

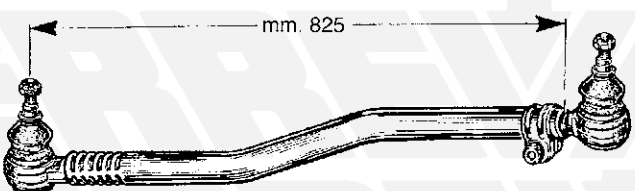

15 - 712701

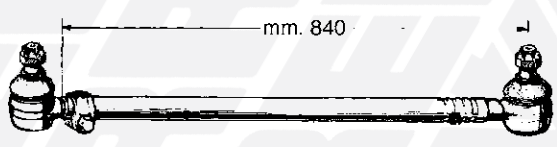

16 - 712934

| FIG. ITEM  | RIF. ERREVI ERREVI REF. | DESCRIZIONE PARTICOLARI DESCRIPTION               | TIPO VEHICLE MODEL  | RIF. ORIG. ORIG. REF.  |
|--|-------------------------|---|---|--|
| <div style="font-size: 2em; font-weight: bold; border: 1px solid black; border-radius: 50%; width: 40px; height: 40px; display: flex; align-items: center; justify-content: center; margin: 0 auto;">1</div> <span style="font-size: 2em; font-weight: bold; margin-left: 10px;">MAN</span>      |                         |   |   |  |
| 1  | <b>712938</b>           | Tirante longitudinale completo / <i>Drag link</i> | <b>L = 980 mm</b> F2000   | 81466106779<br>81466106780<br>81466106782  |
| 2  | <b>712939</b>           | Tirante longitudinale completo / <i>Drag link</i> | <b>L = 1750 mm</b> F2000  | 81466106790<br>81466106791<br>82466106191  |
| 3  | <b>712739</b>           | Tirante longitudinale completo / <i>Drag link</i> | <b>L = 955 mm</b> E2000 - F2000 - F90   | 81466106721<br>81466106722<br>81466106723  |
| 4  | <b>712740</b>           | Tirante longitudinale completo / <i>Drag link</i> | <b>L = 800 mm</b> L2000 - M2000   | 85466106021<br>85466106121<br>85466106140<br>85466106221                               |
| 5  | <b>712737</b>           | Tirante longitudinale completo / <i>Drag link</i> | <b>L = 935 mm</b> TGX - TGA - TGS   | 81466116096<br>81466116097<br>81466116133<br>81466116197<br>81466116198                |
| 6  | <b>712738</b>           | Tirante longitudinale completo / <i>Drag link</i> | <b>L = 915 mm</b> TGX - TGA - TGS   | 81466116135<br>81466116137<br>81466116199<br>81466116200<br>81466116206                |
| 7  | <b>712760</b>           | Tirante longitudinale completo / <i>Drag link</i> | <b>L=1600 mm</b> TGA - TGS - TGX  | 81467116785<br>81467116846<br>81467116711<br>81467106934<br>81467106933<br>81467106932 |
| <div style="font-size: 2em; font-weight: bold; border: 1px solid black; border-radius: 50%; width: 40px; height: 40px; display: flex; align-items: center; justify-content: center; margin: 0 auto;">2</div> <span style="font-size: 2em; font-weight: bold; margin-left: 10px;">MERCEDES</span> |                         |   |   |  |
| 8  | <b>712707</b>           | Tirante longitudinale completo / <i>Drag link</i> | <b>L = 683 mm</b> 814 - 914   | 6734600205<br>6734600405<br>6734600605<br>6734600805                                   |
| 9  | <b>712692</b>           | Tirante longitudinale completo / <i>Drag link</i> | <b>L = 815 mm</b> 1626 - 1632 - 1919 - 1922 - 1926<br>1928 - 1932 - 1933 - 1936 - 1938<br>2226 - 2232 - 2433 - 2528 - 2536<br>2626 - 2628 - 2632 - 2635 - 2636<br>2645 - 3036 - 3332 - 3336 | 3874600705<br>3874601405<br>3874603205<br>3874603305                                   |
| 10   | <b>712908</b>           | Tirante longitudinale completo / <i>Drag link</i> | <b>L = 735 mm</b> 1114 - 1117 - 1120<br>1314 - 1317 - 1320  | 6754601005<br>6754601605<br>6754602205<br>6754602805                                   |
| 11   | <b>712909</b>           | Tirante longitudinale completo / <i>Drag link</i> | <b>L = 740 mm</b> 1314 - 1317 - 1320  | 6764600105<br>6764600605<br>6764601105<br>6764601505                                   |
| 12   | <b>712705</b>           | Tirante longitudinale completo / <i>Drag link</i> | <b>L = 817 mm</b> 1626S - 1632S - 1919S - 1926S - 1932S<br>2026 (6x2 - 6x4) - 2032 (6x2 - 6x4)<br>2226 (6x2) - 2232S (6x4)<br>2626S (6x4) - 2632S (6x4)                                     | 3874600605<br>3874604405<br>3874604505   |
| 13   | <b>712741</b>           | Tirante longitudinale completo / <i>Drag link</i> | <b>L = 780 mm</b> Serie MK - SK   | 0014602905<br>0014603005   |
| 14   | <b>712764</b>           | Tirante longitudinale completo / <i>Drag link</i> | <b>L = 835 mm</b> ATEGO - ATEGO 2   | 9744601205<br>9744601005<br>0034604605<br>3754600005                                   |
| 15   | <b>712701</b>           | Tirante longitudinale completo / <i>Drag link</i> | <b>L = 825 mm</b> ATEGO - AXOR - ACTROS   | 0014606705<br>0004607105<br>0004607205   |
| 16   | <b>712934</b>           | Tirante longitudinale completo / <i>Drag link</i> | <b>L = 840 mm</b> ATEGO - AXOR - ACTROS   | 0024604505<br>0024604605<br>3754600405   |

**STERZO STEERING**

1

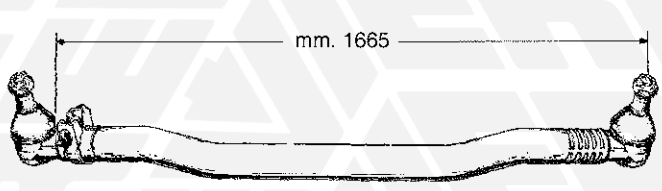

1 - 712935



2 - 712744

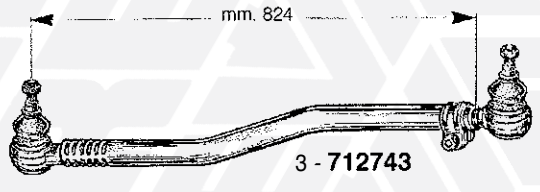

3 - 712743

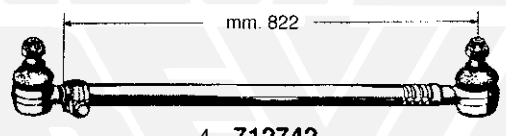

4 - 712742

2



5 - 712725

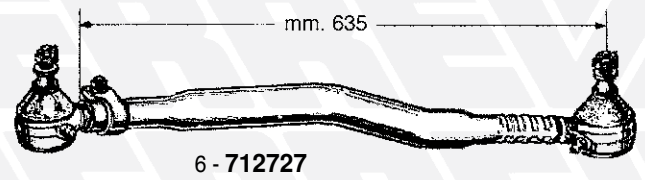

6 - 712727

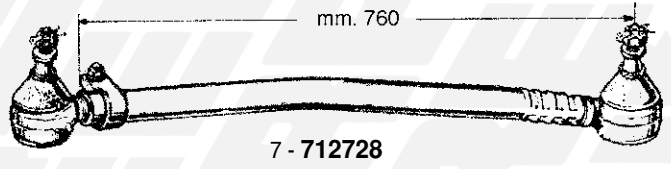

7 - 712728

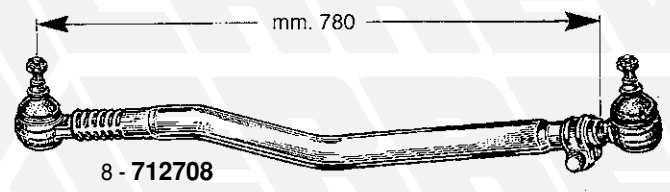

8 - 712708

3

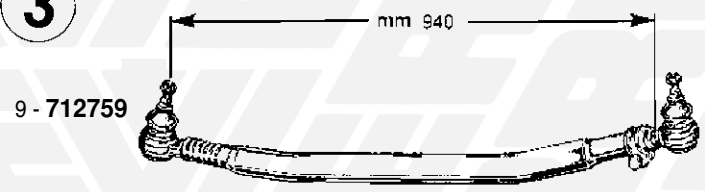

9 - 712759

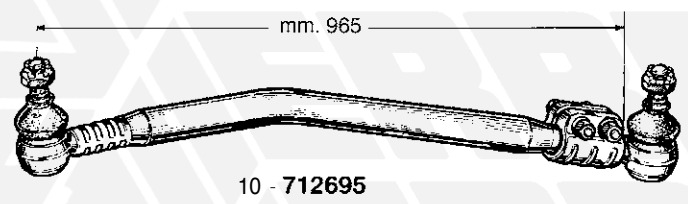

10 - 712695

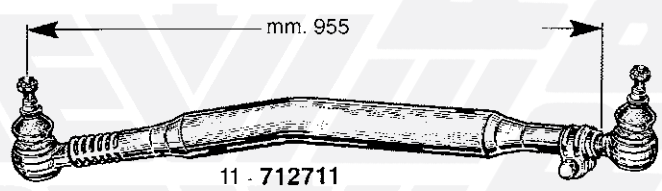

11 - 712711



12 - 712749

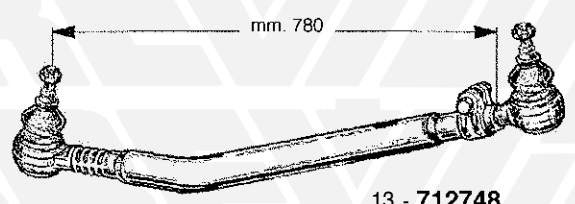

13 - 712748

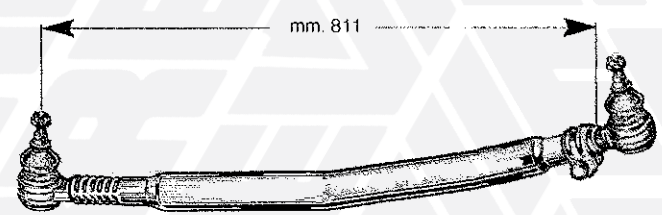

14 - 712750



15 - 712766

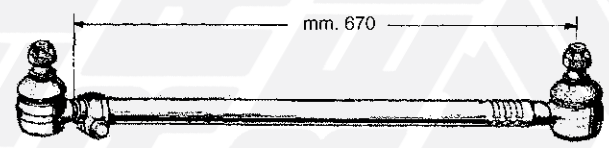

16 - 712745

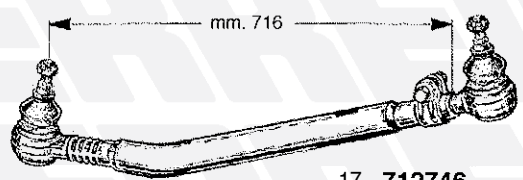

17 - 712746

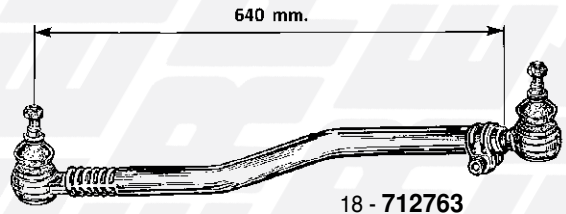

18 - 712763

| FIG. ITEM           | RIF. ERREVI ERREVI REF. | DESCRIZIONE PARTICOLARI DESCRIPTION        |             | TIPO VEHICLE MODEL  | RIF. ORIG. ORIG. REF.  |
|---------------------|-------------------------|--|-------------|---|--|
| <h1>1 MERCEDES</h1> |                         |  |             |   |  |
| 1                   | 712935                  | Tirante longitudinale completo / Drag link | L = 1665 mm | ATEGO - AXOR - ACTROS   | 9423300003<br>9423300103<br>9423300203<br>9423300703<br>9423301103 |
| 2                   | 712744                  | Tirante longitudinale completo / Drag link | L = 830 mm  | ACTROS  | 0014600705<br>0014600805<br>0014607005                             |
| 3                   | 712743                  | Tirante longitudinale completo / Drag link | L = 824 mm  | ATEGO - AXOR - AXOR 2<br>ACTROS - ACTROS MP2                      | 0024604705<br>0024604805   |
| 4                   | 712742                  | Tirante longitudinale completo / Drag link | L = 822 mm  | AXOR - AXOR 2<br>ACTROS - ACTROS MP2                              | 0024604305<br>0024604405   |
| <h1>2 NISSAN</h1>   |                         |  |             |   |  |
| 5                   | 712725                  | Tirante longitudinale completo / Drag link | L = 760 mm  | TRADE 2.8 - 3.0 - 100   | 11505036-0   |
| 6                   | 712727                  | Tirante longitudinale completo / Drag link | L = 635 mm  | CABSTAR 110 / 120   | 48510F3900   |
| 7                   | 712728                  | Tirante longitudinale completo / Drag link | L = 760 mm  | ECO L60<br>ECO L70  | 485109X102<br>11200481-0   |
| 8                   | 712708                  | Tirante longitudinale completo / Drag link | L = 780 mm  | ECOT 100 - 35.08 - 35.09<br>35095                                 | 11200454-0<br>485109x101   |
| <h1>3 RENAULT</h1>  |                         |  |             |   |  |
| 9                   | 712759                  | Tirante longitudinale completo / Drag link | L = 940     | MANAGER G<br>SERIE G / G SERIES                                   | 5000745719<br>5000791330<br>5010144551<br>5010144556               |
| 10                  | 712695                  | Tirante longitudinale completo / Drag link | L = 965 mm  | 350 - 360 - 365 - 370<br>380 - 390 - 420<br><br>GAMMA / RANGE "R" | 5000748868<br>5010130453<br>5010138060<br>5000748784               |
| 11                  | 712711                  | Tirante longitudinale completo / Drag link | L = 955 mm  | GAMMA / RANGE "R"   | 5010130739<br>5010239340<br>5010239386                             |
| 12                  | 712749                  | Tirante longitudinale completo / Drag link | L = 770 mm  | PREMIUM   | 5010294288   |
| 13                  | 712748                  | Tirante longitudinale completo / Drag link | L = 780 mm  | PREMIUM<br>PREMIUM 2  | 5010294287   |
| 14                  | 712750                  | Tirante longitudinale completo / Drag link | L = 811 mm  | PREMIUM<br>PREMIUM 2  | 5010294289   |
| 15                  | 712766                  | Tirante longitudinale completo / Drag link | L = 820 mm  | PREMIUM 2   | 5001868384<br>5010630822<br>5010630823<br>7421560882               |
| 16                  | 712745                  | Tirante longitudinale completo / Drag link | L = 670 mm  | MAGNUM<br>MAGNUM E.TECH   | 5010060764<br>5010557243   |
| 17                  | 712746                  | Tirante longitudinale completo / Drag link | L = 716 mm  | MAGNUM<br>MAGNUM E.TECH   | 5010130344   |
| 18                  | 712763                  | Tirante longitudinale completo / Drag link | L = 640 mm  | MAGNUM DXI  | 5001868374<br>5010630638<br>5010630637<br>7421560825               |

1

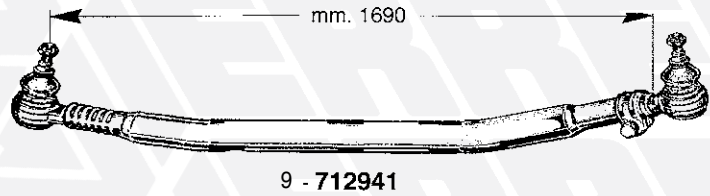
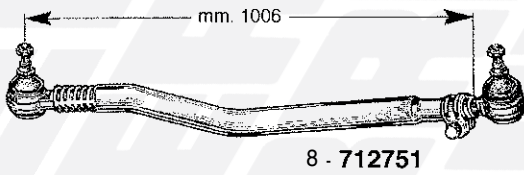
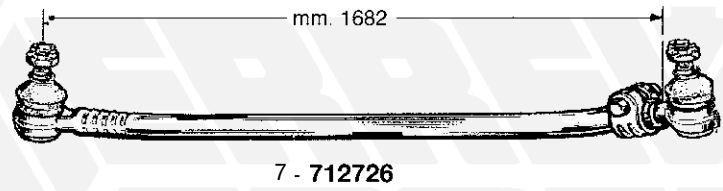
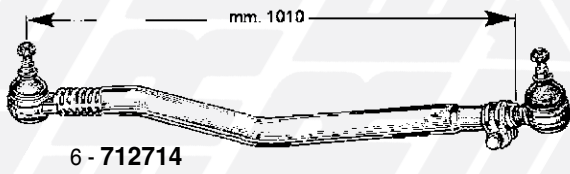
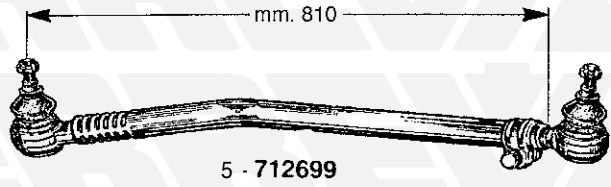
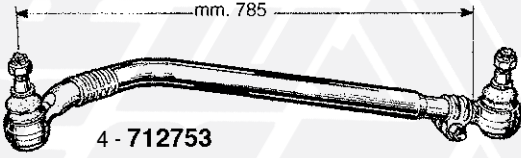
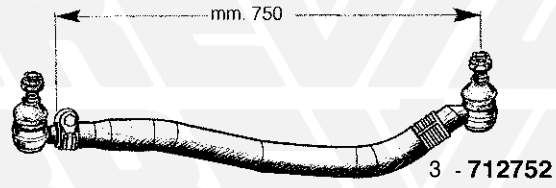
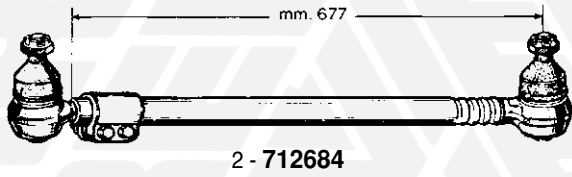
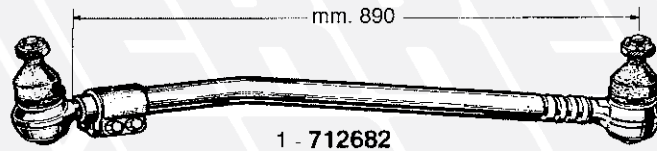

2

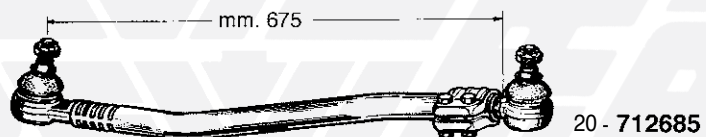
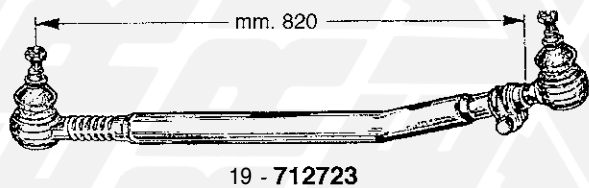
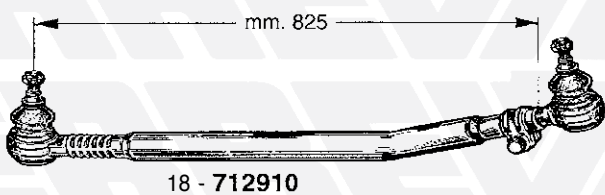
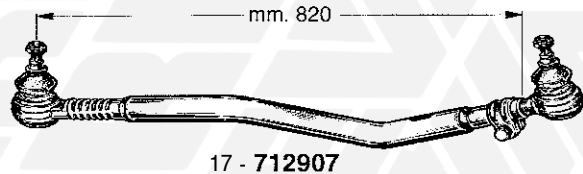
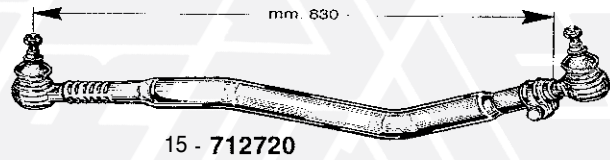
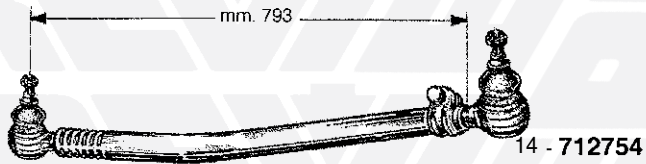
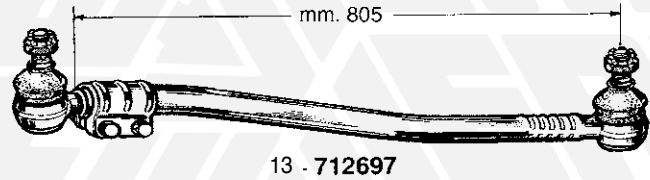
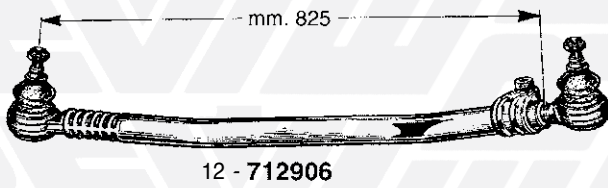
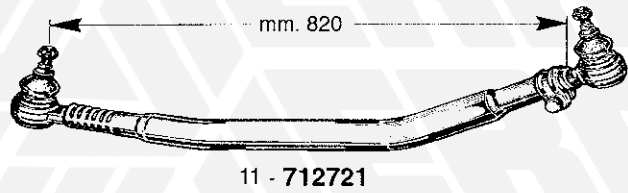
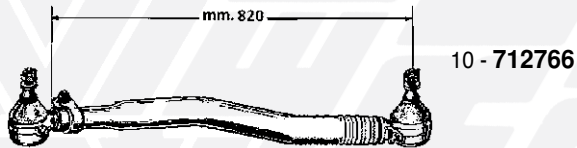

| FIG. ITEM                                | RIF. ERREVI ERREVI REF. | DESCRIZIONE PARTICOLARI DESCRIPTION                           |                    | TIPO VEHICLE MODEL  | RIF. ORIG. ORIG. REF.                               |
|--|-------------------------|---|--------------------|---|---|
| <div style="text-align: center;"> </div> |                         |   |                    |   |   |
| 1  | <b>712682</b>           | Tirante longitudinale completo / <i>Drag link</i>             | <b>L = 890 mm</b>  | 142 - 143   | 278665<br>278666                                    |
| 2  | <b>712684</b>           | Tirante longitudinale completo / <i>Drag link</i>             | <b>L = 677 mm</b>  | 111 - 141   | 291396  |
| 3  | <b>712752</b>           | Tirante longitudinale completo / <i>Drag link</i>             | <b>L = 750 mm</b>  | 93 - 113 - 143  | 1305012<br>1324483                                  |
| 4  | <b>712753</b>           | Tirante longitudinale completo / <i>Drag link</i>             | <b>L = 785 mm</b>  | 93 - 113 - 143  | 1112511   |
| 5  | <b>712699</b>           | Tirante longitudinale completo / <i>Drag link</i>             | <b>L = 810 mm</b>  | 113 - 143   | 390784  |
| 6  | <b>712714</b>           | Tirante longitudinale completo / <i>Drag link</i>             | <b>L = 1010 mm</b> | 114L - 114C - 114G - 124L - 124C<br>124G - 144L - 144C - 144G | 1356055<br>1379071<br>1384025                       |
| 7  | <b>712726</b>           | Tirante longitudinale completo / <i>Drag link</i>             | <b>L = 1682 mm</b> | 114 - 124 - 144   | 1409918<br>1385251<br>1369411<br>1723865<br>1737683 |
| 8  | <b>712751</b>           | Tirante longitudinale completo / <i>Drag link</i>             | <b>L = 1006 mm</b> | 94 - 114 - 124 - 144  | 1384027<br>1769597<br>1847312                       |
| 9  | <b>712941</b>           | Tirante longitudinale completo / <i>Drag link</i>             | <b>L = 1690 mm</b> | 94 - 114 - 124 - 144 - 164                                    | 1897333<br>1734019<br>1361413<br>1395614            |
| <div style="text-align: center;"> </div> |                         |   |                    |   |   |
| 10                                       | <b>712766</b>           | Tirante longitudinale completo / <i>Drag link</i>             | <b>L = 820 mm</b>  | FE  | 21560882<br>20727843<br>25379293                    |
| 11                                       | <b>712721</b>           | Tirante longitudinale completo / <i>Drag link</i>             | <b>L = 820 mm</b>  | FL6 - FL2   | 1071344   |
| 12                                       | <b>712906</b>           | Tirante longitudinale completo / <i>Drag link</i>             | <b>L = 825 mm</b>  | F10 - F12   | 1606283   |
| 13                                       | <b>712697</b>           | Tirante longitudinale completo / <i>Drag link</i>             | <b>L = 805 mm</b>  | F10 - F12 - F16   | 1626751   |
| 14                                       | <b>712754</b>           | Tirante longitudinale completo / <i>Drag link</i>             | <b>L=793 mm</b>    | F10 - F12 - F16   | 1083744   |
| 15                                       | <b>712720</b>           | Tirante longitudinale completo / <i>Drag link</i>             | <b>L = 830 mm</b>  | FH12 - FH16 - FM7 - FM10 - FM12<br><br>SOSP. PNEUM. ANT.      | 3988695<br>3988697<br>20393061                      |
| 16                                       | <b>712756</b>           | Tirante longitudinale completo / <i>Drag link</i>             | <b>L=803 mm</b>    | FM10 - FM12<br>FH12 - FH16                                    | 20375555<br>20393186<br>21106930<br>3986452         |
| 17                                       | <b>712907</b>           | Tirante longitudinale completo / <i>Drag link</i>             | <b>L = 820 mm</b>  | FH12 - FH16   | 1075005   |
| 18                                       | <b>712910</b>           | Tirante longitudinale completo <b>U.T.</b> / <i>Drag link</i> | <b>L = 825 mm</b>  | FH12 - FH16   | 1075663<br>20393069<br>3988704                      |
| 19                                       | <b>712723</b>           | Tirante longitudinale completo <b>U.T.</b> / <i>Drag link</i> | <b>L = 820 mm</b>  | FH16  | 1075664<br>3988701                                  |
| 20                                       | <b>712685</b>           | Tirante longitudinale completo / <i>Drag link</i>             | <b>L = 675 mm</b>  | N12   | 1626493   |

**STERZO STEERING**

| FIG. ITEM | RIF. ERREVI ERREVI REF. | DESCRIZIONE PARTICOLARI DESCRIPTION | TIPO VEHICLE MODEL | RIF. ORIG. ORIG. REF. |
|-----------|-------------------------|-------------------------------------|--------------------|-----------------------|
|-----------|-------------------------|-------------------------------------|--------------------|-----------------------|

## TESTE PER TIRANTI STERZO E BARRE ACCOPPIAMENTO / TIE-ROD ENDS

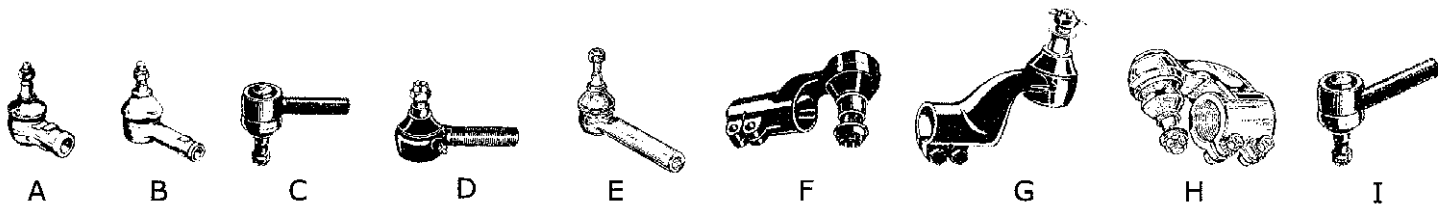

### ASTRA

|   |               |   |                     |   |                  |
|---|---------------|---|---------------------|---|------------------|
| C | <b>713224</b> | Testa completa D. / <i>Tie-rod end RH</i> | M38x1,5-<br>M30x1,5 | BM304F-BM305F-BM64.26/.30/.36)<br>HD7 - HD8 (4x2 - 6x4 - 8x4)     | 101347<br>113251 |
| C | <b>713223</b> | Testa completa S. / <i>Tie-rod end LH</i> | M38x1,5-<br>M30x1,5 | BM304F - BM305F - BM64.26/ .30/.36<br>HD7 - HD8 (4x2 - 6x4 - 8x4) | 101348<br>113252 |
| C | <b>713181</b> | Testa completa D. / <i>Tie-rod end RH</i> | M30x1,5-<br>M24x1,5 | HD8 (4x2 - 6x4 - 8x4)   | 114945           |
| C | <b>713182</b> | Testa completa S. / <i>Tie-rod end LH</i> | M30x1,5-<br>M24x1,5 | HD8 (4x2 - 6x4 - 8x4)   | 114946           |

### DAF

|   |               |  |                     |  |   |
|---|---------------|--|---------------------|--|---|
| C | <b>713243</b> | Testa completa D. / <i>Tie-rod end RH</i>                                    | M24x1,5-<br>M16x1,5 | 65CF - 75CF - 85CF - 95XF                            | 0608530   |
| C | <b>713034</b> | Testa completa D. / <i>Tie-rod end RH</i>                                    | M28x1,5-<br>M18x1,5 | F1200 - F1700 - F1900<br>45FA                        | 0110197<br>0607451<br>0607453<br>1228114            |
| C | <b>713035</b> | Testa completa S. / <i>Tie-rod end LH</i>                                    | M28x1,5-<br>M18x1,5 | F1200 - F1700 - F1900<br>45FA                        | 0110196<br>0607452                                  |
| C | <b>713188</b> | Testa completa D. / <i>Tie-rod end RH</i>                                    | M28x1,5-<br>M20x1,5 | LF45   | AMPA346<br>1689604                                  |
| C | <b>713189</b> | Testa completa S. / <i>Tie-rod end LH</i>                                    | M28x1,5-<br>M20x1,5 | LF45   | AMPA345<br>1689605                                  |
| I | <b>713247</b> | Testa completa D. (barra accoppiamento)<br><i>Tie-rod end RH (track rod)</i> |                     | LF55   | 1603883<br>1149875                                  |
| C | <b>713181</b> | Testa completa D. / <i>Tie-rod end RH</i>                                    | M30x1,5-<br>M24x1,5 | F2100-F2300-F2500-F2700<br>CF65 - CF75 - CF85 - XF95 | 0586714<br>0607073<br>0609634<br>0609643<br>0696226 |
| C | <b>713182</b> | Testa completa S. / <i>Tie-rod end LH</i>                                    | M30x1,5-<br>M24x1,5 | F2100-F2300-F2500-F2700<br>CF65 - CF75 - CF85 - XF95 | 0696225<br>1228115                                  |
| C | <b>713210</b> | Testa completa D. / <i>Tie-rod end RH</i>                                    | M30x1,5-<br>M20x1,5 | 65CF - 75CF - CF75 - CF85                            | 698609<br>607999                                    |
| C | <b>713211</b> | Testa completa S. / <i>Tie-rod end LH</i>                                    | M30x1,5-<br>M20x1,5 | 65CF - 75CF - CF75 - CF85                            | 311300<br>607998                                    |
| C | <b>713251</b> | Testa completa D. (barra accoppiamento)<br><i>Tie-rod end RH (track rod)</i> | M30x1,5-<br>M24x1,5 | F2100-F2300<br>F2500-F2800<br>F3300-F3600            | 586714<br>607073<br>609643                          |
| H | <b>713240</b> | Testa completa D. / <i>Tie-rod end RH</i>                                    | M46x1,5-<br>M24x1,5 | F1600-F2100-F2300-F2800-<br>F3300-F3600              | 0606922   |
| H | <b>713241</b> | Testa completa S. / <i>Tie-rod end LH</i>                                    | M46x1,5-<br>M24x1,5 | F1600-F2100-F2300-F2800-<br>F3300-F3600              | 0606923   |
| H | <b>713218</b> | Testa completa D. / <i>Tie-rod end RH</i>                                    | M48x1,5-<br>M24x1,5 | 65CF - 75CF - 85CF - 95XF                            | 0067389   |
| H | <b>713219</b> | Testa completa S. / <i>Tie-rod end LH</i>                                    | M48x1,5-<br>M24x1,5 | 65CF - 75CF - 85CF - 95XF                            | 0067303   |



| FIG. ITEM | RIF. ERREVI ERREVI REF. | DESCRIZIONE PARTICOLARI DESCRIPTION  |                     | TIPO VEHICLE MODEL   | RIF. ORIG. ORIG. REF. |
|-----------|-------------------------|--|---------------------|--|-----------------------|
|           |                         |  |                     |  |                       |
| A         | <b>713201</b>           | Testina per tirante scatola sterzo / <i>Tie-rod end, steering gear</i>             | M16x1,5-<br>M12x1,5 | DUCATO - TALENTO   | 9750079980            |
| E         | <b>713222</b>           | Testina per tirante scatola sterzo / <i>Tie-rod end, steering gear</i>             | M16x1,5-<br>M12x1,5 | DUCATO   | 1306716080            |
| C         | <b>713001</b>           | Testa completa D. / <i>Tie-rod end RH</i>  | M16x1-<br>M12x1,5   | 616N1/ N2/ N3/ N3-4  | 814304                |
| C         | <b>713002</b>           | Testa completa S. / <i>Tie-rod end LH</i>  | M16x1-<br>M12x1,5   | 616N1/ N2/ N3/ N3-4  | 814305                |
| C         | <b>713009</b>           | Testa completa D. / <i>Tie-rod end RH</i>  | M18x1,5-<br>M14x1,5 | 625N1/ N2/ N3<br>35NC - 40NC - 45NC - OM40 U.T.  | 4579231               |
| C         | <b>713010</b>           | Testa completa S. / <i>Tie-rod end LH</i>  | M18x1,5-<br>M14x1,5 | 625N1/ N2/ N3<br>35NC - 40NC - 45NC - OM50 U.T.  | 4579232               |
| C         | <b>713036</b>           | Testa completa D. / <i>Tie-rod end RH</i>  | M24x1,5-<br>M18x1,5 | GAMMA "Z" - 50NC - 55NC  | 8558524               |
| C         | <b>713037</b>           | Testa completa S. / <i>Tie-rod end LH</i>  | M24x1,5-<br>M18x1,5 | GAMMA "Z" - 50NC - 55NC  | 8558527               |
| C         | <b>713034</b>           | Testa completa D. / <i>Tie-rod end RH</i>  | M28x1,5-<br>M18x1,5 | GAMMA "Z" - OM65 - OM70 - OM75<br>65/70/75/80/90 NC  | 4833825<br>8558533    |
| C         | <b>713035</b>           | Testa completa S. / <i>Tie-rod end LH</i>  | M28x1,5-<br>M18x1,5 | GAMMA "Z" - OM65 - OM70 - OM75<br>65/70/75/80/90 NC  | 4833826<br>8558536    |
| D         | <b>713024</b>           | Testa completa D. / <i>Tie-rod end RH</i>  | M25x1,5-<br>M16x1,5 | 645/650 - 650E - 655 - 662<br>100NC - 110NC - 100.13/F13<br>LUPETTO - LEONCINO<br>CERBIATTO - DAINO - TIGROTTO | 4663787<br>4018036    |
| D         | <b>713025</b>           | Testa completa S. / <i>Tie-rod end LH</i>  | M25x1,5-<br>M16x1,5 | 645/650 - 650E - 655 - 662<br>100NC - 110NC - 100.13/F13<br>LUPETTO - LEONCINO<br>CERBIATTO - DAINO - TIGROTTO | 4663791<br>4018037    |
| D         | <b>713011</b>           | Testa completa D. / <i>Tie-rod end RH</i>  | M28x1,5-<br>M22x1,5 | 643 - 673 - 130NC/ NR/ NT  | 4663972<br>4028250    |
| D         | <b>713012</b>           | Testa completa S. / <i>Tie-rod end LH</i>  | M28x1,5-<br>M22x1,5 | 643 - 673 - 130NC/ NR/ NT  | 4663974<br>4028251    |
| C         | <b>713188</b>           | Testa completa D. / <i>Tie-rod end RH</i>  | M28x1,5-<br>M20x1,5 | GAMMA "Z"-115.14/.17 - 135.14/.17<br>145.17 - 150.14/.17 - 150NC17/ NC20                                       | 4688941               |
| C         | <b>713189</b>           | Testa completa S. / <i>Tie-rod end LH</i>  | M28x1,5-<br>M20x1,5 | GAMMA "Z"-115.14/.17 - 135.14/.17<br>145.17 - 150.14/.17 - 150NC17/ NC20                                       | 4688942               |
| F         | <b>713020</b>           | Testa completa D. / <i>Tie-rod end RH</i>  | M45x1,5-<br>M22x1,5 | 682 - 690 - 691 - 180NC  | 4664349<br>4510017    |
| F         | <b>713021</b>           | Testa completa S. / <i>Tie-rod end LH</i>  | M45x1,5-<br>M22x1,5 | 682 - 690 - 691 - 180NC  | 4664347<br>4510018    |
| D         | <b>713016</b>           | Testa completa per tirante longitudinale senza servosterzo<br><i>Drag link end</i> | M38x1,5-<br>M22x1,5 | 682N2/ N3/ T2/ T3  | 4664292<br>4510019    |
| G         | <b>713022</b>           | Testa completa D. / <i>Tie-rod end RH</i>  | M52x1,5-<br>M22x1,5 | 684 - 160NC - 619N1 - 697 - 300PC  | 4732041<br>4664353    |
| G         | <b>713023</b>           | Testa completa S. / <i>Tie-rod end LH</i>  | M52x1,5-<br>M22x1,5 | 684 - 160NC - 619N1 - 697 - 300PC  | 4732042<br>4664351    |
| D         | <b>713016</b>           | Testa completa D. / <i>Tie-rod end RH</i>  | M38x1,5-<br>M22x1,5 | 683/619 - 693  | 4664292<br>4510019    |
| D         | <b>713017</b>           | Testa completa S. / <i>Tie-rod end LH</i>  | M38x1,5-<br>M22x1,5 | 683/619 - 693  | 4664295<br>4523292    |

I marchi ed i nominativi dei costruttori come pure i riferimenti originali sono esposti a solo titolo indicativo in quanto i nostri particolari non sono originali  
 Manufacturer's names and part numbers in this catalogue are used for cross reference purposes only and do not imply anything about the origin or manufacturer of product.

| FIG. ITEM                            | RIF. ERREVI ERREVI REF. | DESCRIZIONE PARTICOLARI DESCRIPTION                                    |                     | TIPO VEHICLE MODEL  | RIF. ORIG. ORIG. REF.  |
|--------------------------------------|-------------------------|--|---------------------|---|--|
|                                      |                         |  |                     |   |  |
| <h2 style="color: green;">IVECO</h2> |                         |  |                     |   |  |
| B                                    | <b>713040</b>           | Testa per estremità tirante / <i>Tie-rod end</i>                       | M16x1,5-<br>M14x1,5 | <b>DAILY-NEW DAILY - TURBO DAILY</b>  | 1903652<br>93800662  |
| A                                    | <b>713409</b>           | Testina per tirante scatola sterzo / <i>Tie-rod end, steering gear</i> | M16x1,5-<br>M14x1,5 | <b>DAILY 2000</b><br>35C9/C10/C11/C12/C13/C15<br>50C11/C13/C15-65C11/C13/C15  | 42534911   |
| C                                    | <b>713090</b>           | Testa completa D. / <i>Tie-rod end RH</i>                              | M38x1,5-<br>M24x1,5 | 159NC17/NC20 - 159.17/.20 - 165.24R<br>175.17/.24R - 160.26 - 180.24/ .26<br>170/190 e deriv. - 190.30/ .38 U.T.  | 4688948  |
| C                                    | <b>713091</b>           | Testa completa S. / <i>Tie-rod end LH</i>                              | M38x1,5-<br>M24x1,5 | <b>TURBOSTAR</b> 190.33/.36/.42/.48<br><b>TURBOTECH</b> 190.30-240.26-260.32<br>220.38PT - 240.30P<br>240.38P - 240.48  | 4688949  |
| C                                    | <b>713181</b>           | Testa completa D. / <i>Tie-rod end RH</i>                              | M30x1,5-<br>M24x1,5 | 190.30/ .38 U.T.<br><b>TURBOSTAR</b> 190.33/ .36/ .42/ .48<br>220.36PT/.38PT - 240.36/.38P/.48<br>260.26H/.26N/.35H - 190.30H<br>330F26/F35 - 330.26H/26N/30H/35H/36H   | 4833822<br>4833829<br>42483386<br>42488269<br>42489573<br>4822406                      |
| C                                    | <b>713182</b>           | Testa completa S. / <i>Tie-rod end LH</i>                              | M30x1,5-<br>M24x1,5 | <b>EUROCARGO</b><br>95E15/E21-135E18/E23<br>150E15H/E18H/E21H/E23H<br>170E15/E18/E23/E27<br><b>EUROCARGO "TECTOR"</b><br>100E18/E21-150E18/E24<br>180E21/E24/E28<br><b>EUROTECH - EUROTECH "CURSOR"</b><br><b>EUROSTAR - EUROSTAR "CURSOR"</b><br><b>EUROTRAKKER</b><br><b>EUROTRAKKER "CURSOR" - STRALIS</b> | 4833823<br>4833830<br>42489395<br>42489574<br>42491957<br>4822407                      |
| C                                    | <b>713210</b>           | Testa completa D. / <i>Tie-rod end RH</i>                              | M30x1,5-<br>M20x1,5 | <b>EUROCARGO</b><br><b>EUROCARGO "TECTOR"</b>   | 4833827  |
| C                                    | <b>713211</b>           | Testa completa S. / <i>Tie-rod end LH</i>                              | M30x1,5-<br>M20x1,5 | <b>EUROCARGO</b><br><b>EUROCARGO "TECTOR"</b>   | 4833828  |
| <h2 style="color: green;">MAN</h2>   |                         |  |                     |   |  |
| C                                    | <b>713243</b>           | Testa completa D. / <i>Tie-rod end RH</i>                              | M24x1,5-<br>M16x1,5 | L2000 - TGA   | 81953016142<br>81953010077   |
| C                                    | <b>713244</b>           | Testa completa S. / <i>Tie-rod end LH</i>                              | M24x1,5-<br>M16x1,5 | L2000 - TGA   | 81953016141<br>81953010078   |
| C                                    | <b>713034</b>           | Testa completa D. / <i>Tie-rod end RH</i>                              | M28x1,5-<br>M18x1,5 | G90 - L2000 - M2000 - TGL   | 81953016060<br>81953016135<br>81953016140<br>81953016249<br>81953016328<br>81953016358 |
| C                                    | <b>713035</b>           | Testa completa S. / <i>Tie-rod end LH</i>                              | M28x1,5-<br>M18x1,5 | G90 - L2000 - M2000 - TGL   | 81953010079<br>81953016139<br>81953016222  |
| C                                    | <b>713181</b>           | Testa completa D. / <i>Tie-rod end RH</i>                              | M30x1,5-<br>M24x1,5 | F90 - M90 - F2000 - L2000 - M2000   | 81953010088<br>81953016234<br>81953016242<br>81953010016                               |
| C                                    | <b>713182</b>           | Testa completa S. / <i>Tie-rod end LH</i>                              | M30x1,5-<br>M24x1,5 | F90 - M90 - F2000 - L2000 - M2000   | 81953016179<br>81953016223<br>81953016237<br>81953010015                               |

| FIG. ITEM                   | RIF. ERREVI ERREVI REF. | DESCRIZIONE PARTICOLARI DESCRIPTION   |                     | TIPO VEHICLE MODEL  | RIF. ORIG. ORIG. REF.  |
|-----------------------------|-------------------------|---|---------------------|---|--|
|                             |                         |   |                     |   |  |
| <b>Segue: / Cont'd: MAN</b> |                         |   |                     |   |  |
| C                           | <b>713210</b>           | Testa completa D. / <i>Tie-rod end RH</i>                                   | M30x1,5-<br>M20x1,5 | M90 - M2000 - TGL   | 81953016246<br>81953016250<br>81953016239<br>81953010014                         |
| C                           | <b>713211</b>           | Testa completa S. / <i>Tie-rod end LH</i>                                   | M30x1,5-<br>M20x1,5 | M90 - M2000 - TGL   | 81953016068<br>81953016246<br>81953016273<br>81953010013                         |
| C                           | <b>713251</b>           | Testa completa D. (barra accoppiamento) / <i>Tie-rod end RH (track rod)</i> | M30x1,5-<br>M24x1,5 |   | 81953010022  |
| I                           | <b>713247</b>           | Testa completa D. (barra accoppiamento) / <i>Tie-rod end RH (track rod)</i> |                     | M2000 - TGA - TGM - TGS - TGX   | 81953016288  |
| <b>MERCEDES</b>             |                         |   |                     |   |  |
| C                           | <b>713243</b>           | Testa completa D. / <i>Tie-rod end RH</i>                                   | M24x1,5-<br>M16x1,5 | 711 - 709 - 608 - 808 - 809 - 811 - 913<br>1013 - 1017 - 1114 - 1117 - 1120 | 0003308535<br>0003300635<br>0003306735   |
| C                           | <b>713244</b>           | Testa completa S. / <i>Tie-rod end LH</i>                                   | M24x1,5-<br>M16x1,5 | 711 - 709 - 608 - 808 - 809 - 811 - 913<br>1013 - 1017 - 1114 - 1117 - 1120 | 0003308635<br>0003300735<br>0003306835   |
| C                           | <b>713036</b>           | Testa completa D. / <i>Tie-rod end RH</i>                                   | M24x1,5-<br>M18x1,5 | VARIO   | 0003301235<br>0003309935   |
| C                           | <b>713037</b>           | Testa completa S. / <i>Tie-rod end LH</i>                                   | M24x1,5-<br>M18x1,5 | VARIO   | 0003301335<br>0003309835   |
| C                           | <b>713034</b>           | Testa completa D. / <i>Tie-rod end RH</i>                                   | M28x1,5-<br>M18x1,5 | 609D - 709D - 711D - 809D - 811D  | 0003301435<br>0003301535<br>0003309335<br>0003309535<br>0003383629               |
| C                           | <b>713035</b>           | Testa completa S. / <i>Tie-rod end LH</i>                                   | M28x1,5-<br>M18x1,5 | 609D - 709D - 711D - 809D - 811D  | 0003303335<br>0003307235<br>0003309435<br>0003309635                             |
| C                           | <b>713238</b>           | Testa completa D. / <i>Tie-rod end RH</i>                                   | M30x1,5-<br>M27x1,5 | Serie MK-SK-NG Series<br>ATEGO<br>AXOR<br>ACTROS                            | 0004605748<br>0004606048<br>0004607048<br>0004606848<br>0014607648<br>0014601748 |
| C                           | <b>713239</b>           | Testa completa S. / <i>Tie-rod end LH</i>                                   | M30x1,5-<br>M27x1,5 | Serie MK-SK-NG Series<br>ATEGO<br>AXOR<br>ACTROS                            | 0004605848<br>0004606148<br>0004607148<br>0004606948<br>0014607948<br>0014600548 |
| C                           | <b>713210</b>           | Testa completa D. / <i>Tie-rod end RH</i>                                   | M30x1,5-<br>M20x1,5 | Serie MK-SK-LK-NG Series<br>ATEGO - AXOR - ACTROS                           | 0003303235<br>0001330135<br>0001330235   |
| C                           | <b>713211</b>           | Testa completa S. / <i>Tie-rod end LH</i>                                   | M30x1,5-<br>M20x1,5 | Serie MK-SK-LK-NG Series<br>ATEGO - AXOR - ACTROS                           | 0003300148<br>3023300235<br>3023300335   |
| C                           | <b>713181</b>           | Testa completa D. / <i>Tie-rod end RH</i>                                   | M30x1,5-<br>M24x1,5 | Serie MK-SK-LK-NG Series<br>ATEGO - ACTROS                                  | 0004601048<br>0004602848<br>0004602948<br>0004607748                             |
| C                           | <b>713182</b>           | Testa completa S. / <i>Tie-rod end LH</i>                                   | M30x1,5-<br>M24x1,5 | Serie MK-SK-LK-NG Series<br>ATEGO - ACTROS                                  | 0004603448<br>0004603548<br>0014601448   |
| I                           | <b>713247</b>           | Testa completa D. (barra accoppiamento) / <i>Tie-rod end RH (track rod)</i> |                     |   | 0004605248   |

| FIG. ITEM | RIF. ERREVI ERREVI REF. | DESCRIZIONE PARTICOLARI DESCRIPTION | TIPO VEHICLE MODEL | RIF. ORIG. ORIG. REF. |
|-----------|-------------------------|-------------------------------------|--------------------|-----------------------|
|-----------|-------------------------|-------------------------------------|--------------------|-----------------------|

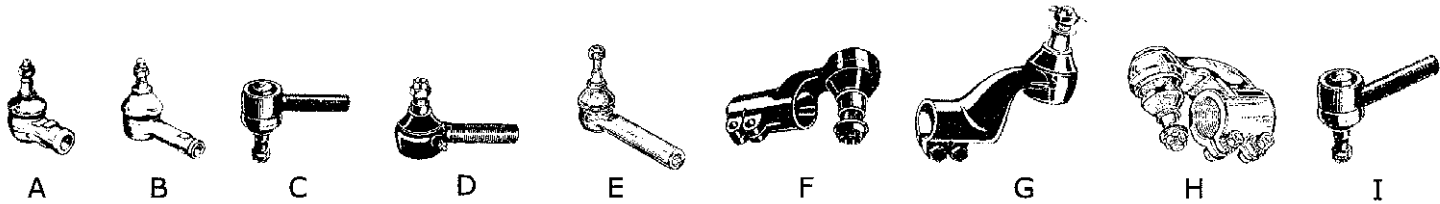

## NISSAN

|   |               |   |                     |   |                          |
|---|---------------|---|---------------------|---|--------------------------|
| C | <b>713228</b> | Testa completa D. / <i>Tie-rod end RH</i> | M22x1,5-<br>M14x1,5 | TRADE L35 - ECO T 100<br>CABSTAR - ATLEON | 11200360-0<br>486479X62A |
| C | <b>713229</b> | Testa completa S. / <i>Tie-rod end LH</i> | M22x1,5-<br>M14x1,5 | TRADE L35 - ECO T 100<br>CABSTAR - ATLEON | 11200361-0<br>485279X62A |

## RENAULT

|   |               |  |                     |  |  |
|---|---------------|--|---------------------|--|--|
| C | <b>713243</b> | Testa completa D. / <i>Tie-rod end RH</i>                                    | M24x1,5-<br>M16x1,5 | MIDLINER                                   | 5000814097<br>5001844136   |
| C | <b>713244</b> | Testa completa S. / <i>Tie-rod end LH</i>                                    | M24x1,5-<br>M16x1,5 | MIDLINER                                   | 5000814096<br>5001844135   |
| C | <b>713034</b> | Testa completa D. / <i>Tie-rod end RH</i>                                    | M28x1,5-<br>M18x1,5 | Serie M - S Series<br>MIDLINER - MIDLUM    | 0003406242<br>5000559335<br>5000823987<br>5001825687<br>5001861924 |
| C | <b>713035</b> | Testa completa S. / <i>Tie-rod end LH</i>                                    | M28x1,5-<br>M18x1,5 | Serie M - S Series<br>MIDLINER - MIDLUM    | 5000559336<br>5000823947<br>5000823997                             |
| C | <b>713181</b> | Testa completa D. / <i>Tie-rod end RH</i>                                    | M30x1,5-<br>M24x1,5 | Serie R Series<br>PREMIUM - MAGNUM - KERAX | 5000288360<br>5010832582   |
| C | <b>713182</b> | Testa completa S. / <i>Tie-rod end LH</i>                                    | M30x1,5-<br>M24x1,5 | Serie R Series<br>PREMIUM - MAGNUM - KERAX | 5000288361<br>5001832581<br>5001832583                             |
| C | <b>713210</b> | Testa completa D. / <i>Tie-rod end RH</i>                                    | M30x1,5-<br>M20x1,5 | MIDLUM<br>MIDLINER<br>MAGNUM E.TECH        | 0003406212<br>0003406253<br>5000295214                             |
| C | <b>713211</b> | Testa completa S. / <i>Tie-rod end LH</i>                                    | M30x1,5-<br>M20x1,5 | MIDLUM - MIDLINER<br>MAGNUM E.TECH         | 0003486218<br>5000295215   |
| C | <b>713090</b> | Testa completa D. / <i>Tie-rod end RH</i>                                    | M38x1,5-<br>M24x1,5 | Serie C - G - R Series                     | 0003401207<br>5001831481<br>5001832580                             |
| C | <b>713091</b> | Testa completa S. / <i>Tie-rod end LH</i>                                    | M38x1,5-<br>M24x1,5 | Serie C - G - R Series                     | 0003401206<br>5001832579   |
| I | <b>713247</b> | Testa completa D. (barra accoppiamento)<br><i>Tie-rod end RH (track rod)</i> | M30x1,5-<br>M24x1,5 | PREMIUM - PREMIUM 2<br>MAGNUM E.TECH       | 5001852452<br>5001858763   |

## SCANIA

|   |               |  |                     |                            |                             |
|---|---------------|--|---------------------|----------------------------|-----------------------------|
| C | <b>713181</b> | Testa completa D. / <i>Tie-rod end RH</i>                                    | M30x1,5-<br>M24x1,5 | Serie 1 -2 - 3 - 4 Series  | 283784<br>395010<br>1358793 |
| C | <b>713182</b> | Testa completa S. / <i>Tie-rod end LH</i>                                    | M30x1,5-<br>M24x1,5 | Serie 1 -2 - 3 - 4 Series  | 283783<br>395009<br>1358792 |
| G | <b>713232</b> | Testa completa D. / <i>Tie-rod end RH</i>                                    | M52x1,5-<br>M24x1,5 | Serie 3 Series             | 310980                      |
| G | <b>713233</b> | Testa completa S. / <i>Tie-rod end LH</i>                                    | M52x1,5-<br>M24x1,5 | Serie 3 Series             | 310979                      |
| I | <b>713247</b> | Testa completa D. (barra accoppiamento)<br><i>Tie-rod end RH (track rod)</i> | M30x1,5-<br>M24x1,5 | 94 - 114 - 124 - 144 - 164 | 1357674<br>1738379          |
| C | <b>713251</b> | Testa completa D. (barra accoppiamento)<br><i>Tie-rod end RH (track rod)</i> | M30x1,5-<br>M24x1,5 | 112<br>93 - 123 - 143      | 1337367<br>352646           |

I marchi ed i nominativi dei costruttori come pure i riferimenti originali sono esposti a solo titolo indicativo in quanto i nostri particolari non sono originali  
*Manufacturer's names and part numbers in this catalogue are used for cross reference purposes only and do not imply anything about the origin or manufacturer of product.*

| FIG. ITEM                            | RIF. ERREVI ERREVI REF. | DESCRIZIONE PARTICOLARI DESCRIPTION  | TIPO VEHICLE MODEL  | RIF. ORIG. ORIG. REF.   |
|--------------------------------------|-------------------------|--|---------------------|---|
|                                      |                         |  |                     |   |
| <h2 style="color: green;">VOLVO</h2> |                         |  |                     |   |
| C                                    | <b>713243</b>           | Testa completa D. / <i>Tie-rod end RH</i>                                    | M24x1,5-<br>M16x1,5 | F10 - F12<br>1190778<br>1517449<br>1518142  |
| C                                    | <b>713244</b>           | Testa completa S. / <i>Tie-rod end LH</i>                                    | M24x1,5-<br>M16x1,5 | F10 - F12<br>1517448  |
| C                                    | <b>713036</b>           | Testa completa D. / <i>Tie-rod end RH</i>                                    | M24x1,5-<br>M18x1,5 | FL6<br>1696919  |
| C                                    | <b>713037</b>           | Testa completa S. / <i>Tie-rod end LH</i>                                    | M24x1,5-<br>M18x1,5 | FL6<br>1696920  |
| C                                    | <b>713034</b>           | Testa completa D. / <i>Tie-rod end RH</i>                                    | M28x1,5-<br>M18x1,5 | F406-F407-F408-F607<br>F608-F609-F610<br>1517440<br>1517444<br>1698191  |
| C                                    | <b>713035</b>           | Testa completa S. / <i>Tie-rod end LH</i>                                    | M28x1,5-<br>M18x1,5 | F406-F407-F408-F607<br>F608-F609-F610<br>1517279<br>1517439<br>1698190  |
| C                                    | <b>713206</b>           | Testa completa D. / <i>Tie-rod end RH</i>                                    | M30x1,5-<br>M20x1,5 | F7-F10-F12-F16<br>FL6-FL7-FL10-FL12<br>FH12<br>1505759<br>1507823<br>1698846<br>1698532                       |
| C                                    | <b>713207</b>           | Testa completa S. / <i>Tie-rod end LH</i>                                    | M30x1,5-<br>M20x1,5 | F7-F10-F12-F16<br>FL6-FL7-FL10-FL12<br>FH12<br>1505758<br>1507822<br>1698847<br>1698533<br>366757<br>85114149 |
| C                                    | <b>713205</b>           | Testa completa D. / <i>Tie-rod end RH</i>                                    | M30x1,5-<br>M24x1,5 | F10 - F12 - F16<br>FL7 - FL10 - FL12<br>FM7 - FM10 - FM12 - N10<br>1695776<br>1695585<br>1698557<br>85114146  |
| C                                    | <b>713209</b>           | Testa completa S. / <i>Tie-rod end LH</i>                                    | M30x1,5-<br>M24x1,5 | F10 - F12 - F16<br>FL7 - FL10 - FL12<br>FM7 - FM10 - FM12 - N10<br>1698558<br>1698840<br>6869744<br>85114147  |
| C                                    | <b>713210</b>           | Testa completa D. / <i>Tie-rod end RH</i>                                    | M30x1,5-<br>M20x1,5 | F6 - FH16<br>FL - FL6 - FLII<br>1517577   |
| C                                    | <b>713211</b>           | Testa completa S. / <i>Tie-rod end LH</i>                                    | M30x1,5-<br>M20x1,5 | F6 - FH16<br>FL - FL6 - FLII<br>1698839<br>1695689  |
| C                                    | <b>713249</b>           | Testa completa D. (barra accoppiamento)<br><i>Tie-rod end RH (track rod)</i> | M30x1,5-<br>M20x1,5 | FM7 - FM9 - FM10 - FM12<br>FH12 - FH16<br>3093647   |
| C                                    | <b>713181</b>           | Testa completa D. / <i>Tie-rod end RH</i>                                    | M30x1,5-<br>M24x1,5 | FL6 - FM - FL<br>20742127<br>20745043<br>20821160<br>20862494   |
| C                                    | <b>713182</b>           | Testa completa S. / <i>Tie-rod end LH</i>                                    | M30x1,5-<br>M24x1,5 | FL6 - FM - FL<br>20745042<br>20742129<br>20894053<br>20821150   |
| G                                    | <b>713234</b>           | Testa completa D. / <i>Tie-rod end RH</i>                                    | M52x1,5-<br>M20x1,5 | F10 - F12 - F16<br>FL7 - FL10 - FL12<br>FM7 - FM10 - FM12 - FH12 - FH16<br>1131742<br>1696901<br>1699401      |
| G                                    | <b>713235</b>           | Testa completa S. / <i>Tie-rod end LH</i>                                    | M52x1,5-<br>M20x1,5 | F10 - F12 - F16<br>FL7 - FL10 - FL12<br>FM7 - FM10 - FM12 - FH12 - FH16<br>1131741<br>1696900<br>1699400      |

1

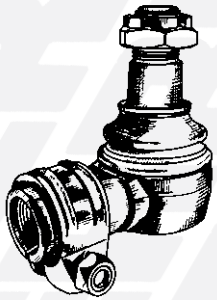

- 1-8-12 - 713108
- 6 - 713105
- 7 - 713106
- 9-13-16-18 - 713116 **NEW**
- 10 - 713107
- 11 - 713100
- 14 - 713113 **NEW**
- 15 - 713114 **NEW**
- 17 - 713115 **NEW**

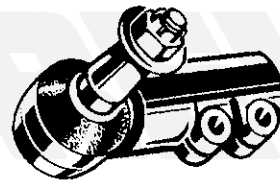

713038  
2



726741  
3

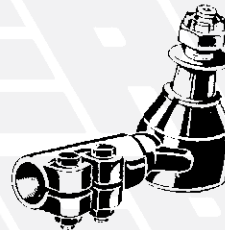

713029  
4



713014  
5

2

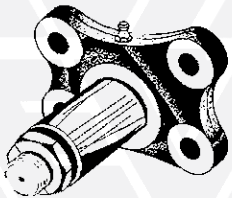

730220  
19

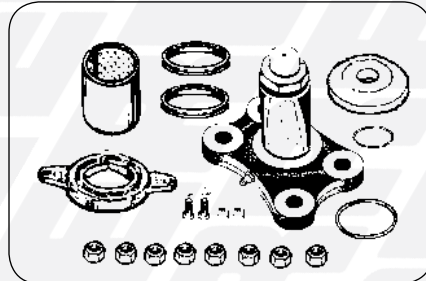

711855  
20  
**NEW**

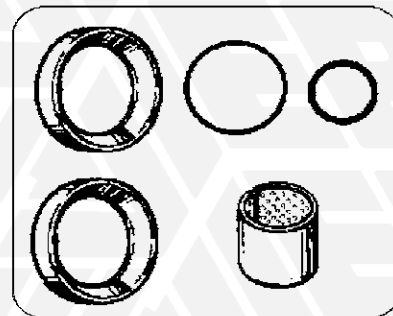

711849  
21

3

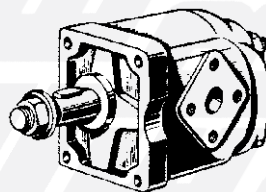

731815  
22

| FIG. ITEM   | RIF. ERREVI ERREVI REF. | DESCRIZIONE PARTICOLARI DESCRIPTION   | TIPO VEHICLE MODEL | RIF. ORIG. ORIG. REF.  |
|---|-------------------------|---|--------------------|--|
| <b>① TESTE PER SERVOSTERZO / POWER-STEERING BALL-JOINTS</b>           |                         |   |                    |  |
| <b>DAF</b>  |                         |   |                    |  |
| 1   | <b>713108</b>           | Testa per cilindro servosterzo con fascetta / <i>Ball-joint c/w clamp</i>               | M26x1,5            | 223712<br>1361618  |
| <b>IVECO</b>  |                         |   |                    |  |
| 2   | <b>713038</b>           | Testa completa anteriore / <i>Ball-joint, front</i>                                     | M30x1,5            | 673 - 100NC - 110NC - 130NC - 110.14   |
| 3   | <b>726741</b>           | Morsetto bloccaggio testa / <i>Clamp</i>  |                    | 682N3/ N4/ T3/ T4  |
| 4   | <b>713029</b>           | Testa completa anteriore G.S. / <i>Ball-joint, front LHD</i>                            | M30x1,5            | 684 - 160NC - 619N1 - 697 - 300PC  |
| 5   | <b>713014</b>           | Testa compl. ant. G.D. / <i>Ball-joint, front RHD</i>                                   | M30x1,5            | 684 - 160NC - 619N1 - 697 - 300PC  |
| 6   | <b>713105</b>           | Testa per cilindro servosterzo con fascetta - lato cuffia / <i>Ball-joint c/w clamp</i> | M26x1,5            | EUROTECH - EUROTECH "CURSOR" E.STAR - E.STAR "CURSOR" - STRALIS                        |
| 7   | <b>713106</b>           | Testa per cilindro servosterzo con fascetta / <i>Ball-joint c/w clamp</i>               | M26x1,5            | EUROTECH - EUROTECH "CURSOR" E.STAR - E.STAR "CURSOR" - STRALIS                        |
| 8   | <b>713108</b>           | Testa per cilindro servosterzo con fascetta / <i>Ball-joint c/w clamp</i>               | M26x1,5            | EUROTRAKKER 340E34/E35/E37/E42 - 410E37/E42  |
| 9   | <b>713116</b>           | Testa per cilindro servosterzo con fascetta / <i>Ball-joint c/w clamp</i>               | M26x1,5            | EUROSTAR - EUROTECH - STRALIS  |
| 10  | <b>713107</b>           | Testa per cilindro servosterzo con fascetta / <i>Ball-joint c/w clamp</i>               | M30x1,5            | EUROTECH - E.STAR - EUROTRAKKER  |
| 11  | <b>713100</b>           | Testa per cilindro servosterzo con fascetta / <i>Ball-joint c/w clamp</i>               | M30x1,5            | EUROTRAKKER "CURSOR"   |
| <b>MAN - MERCEDES</b>   |                         |   |                    |  |
| 12  | <b>713108</b>           | Testa per cilindro servosterzo con fascetta / <i>Ball-joint c/w clamp</i>               | M26x1,5            | 81953016231<br>82953010009<br>6244600348   |
| 13  | <b>713116</b>           | Testa per cilindro servosterzo con fascetta / <i>Ball-joint c/w clamp</i>               | M26x1,5            | E2000 - F2000 - F90 - TGA<br>TGS - TGX<br>Serie NG - SK Series                         |
| <b>RENAULT - VOLVO</b>  |                         |   |                    |  |
| 14  | <b>713113</b>           | Testa per cilindro servosterzo con fascetta / <i>Ball-joint c/w clamp</i>               | M26x1,5            | PREMIUM 2<br>FH12 - FH16 - FM7 - FM9 - FM12  |
| 15  | <b>713114</b>           | Testa per cilindro servosterzo con fascetta / <i>Ball-joint c/w clamp</i>               | M26x1,5            | PREMIUM 2<br>FH12 - FH16 - FM9 - FM12  |
| 16  | <b>713116</b>           | Testa per cilindro servosterzo con fascetta / <i>Ball-joint c/w clamp</i>               | M26x1,5            | PREMIUM  |
| 17  | <b>713115</b>           | Testa per cilindro servosterzo con fascetta / <i>Ball-joint c/w clamp</i>               | M26x1,5            | FH12 - FH16 - FH<br>FM7 - FM10 - FM12 - FMX  |
| <b>SCANIA</b>   |                         |   |                    |  |
| 18  | <b>713116</b>           | Testa per cilindro servosterzo con fascetta / <i>Ball-joint c/w clamp</i>               | M26x1,5            | 94 - 114 - 124 - 144 - 164<br>Serie P - G - R - T Series                               |
| <b>② RINVIO STERZO / STEERING PIN AND KIT</b>                         |                         |   |                    |  |
| <b>SCANIA</b>   |                         |   |                    |  |
| 19  | <b>730220</b>           | Piastra per leva rinvio tirante sterzo / <i>Pivot pin assembly</i>                      |                    | Serie 4 Series<br>1375220<br>1403261<br>1515668<br>1786130<br>486488                   |
| 20  | <b>711855</b>           | Kit per piastra leva rinvio sterzo / <i>Pivot pin repair kit</i>                        |                    | Serie 4 Series<br>1375220S<br>1403261S<br>1515668S<br>1786130S<br>486488S              |
| 21  | <b>711849</b>           | Kit per piastra leva rinvio tirante sterzo / <i>Steering pivot bush kit</i>             |                    | Serie 4 Series<br>1375227<br>1520607<br>1345202  |
| <b>③ SERVOSTERZO / POWER-STEERING POMPA DI COMANDO / PUMP 4522089</b> |                         |   |                    |  |
| <b>FIAT-IVECO</b>   |                         |   |                    |  |
| 22  | <b>731815</b>           | Pompa servosterzo completa / <i>Steering pump</i>                                       |                    | 682 U.T. - 690 U.T. - 691<br>180NC - 619N1 - 697 - 300PC<br>684 - 160NC - 170/190 NC26 |

1

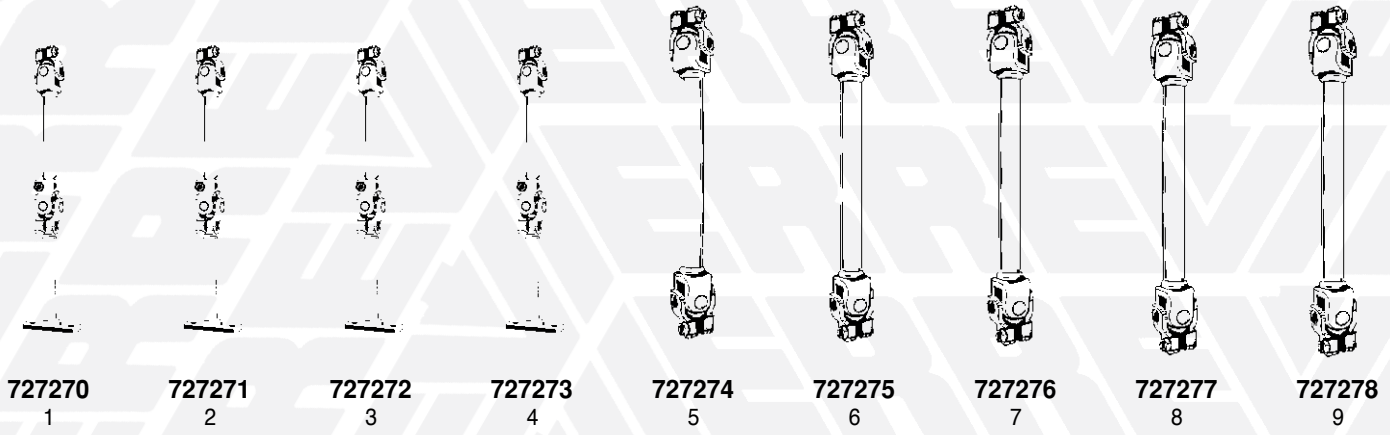

2

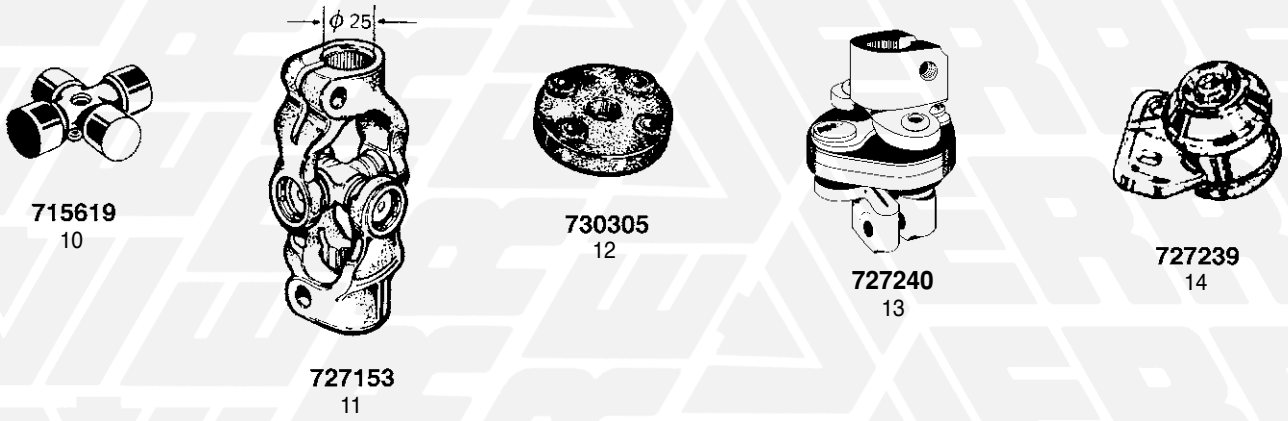

3



4





| FIG. ITEM   | RIF. ERREVI ERREVI REF. | DESCRIZIONE PARTICOLARI DESCRIPTION                                 |                        | TIPO VEHICLE MODEL  | RIF. ORIG. ORIG. REF.                       |
|---|-------------------------|---|------------------------|---|---|
| <h2 style="text-align: center;">1 ALBERI PIANTONE STERZO / STEERING SHAFT ASSEMBLIES</h2> |                         |   |                        |   |   |
| 1   | <b>727270</b>           | Albero sterzo completo / <i>Steering shaft assembly</i>             | ø18 L=420              | DAILY 30.8 - 35.8 - 40.8  | 93802065<br>93806544<br>94700510            |
| 2   | <b>727271</b>           | Albero sterzo completo / <i>Steering shaft assembly</i>             | ø18 L=400              | DAILY 30.8-35.8/.10-40.8-45.10-49.10  | 8585982                                     |
| 3   | <b>727272</b>           | Albero sterzo completo / <i>Steering shaft assembly</i>             | ø18 L=390              | NEW DAILY<br>30.8 - 35.8/.10 - 40.8 - 45.10 - 49.10<br>TURBO DAILY 30.10 - 35.10 - 40.10  | 93812112                                    |
| 4   | <b>727273</b>           | Albero sterzo completo / <i>Steering shaft assembly</i>             | ø18 L=350              | DAILY 30.8 - 35.8/.10 - 40.8 - 49.10<br>NEW DAILY 35.10 - 49.10<br>TURBO DAILY 35.12 - 49.12  | 93802399<br>93806611<br>503475011           |
| 5   | <b>727274</b>           | Albero sterzo completo / <i>Steering shaft assembly</i>             | ø25,5<br>L=430         | 50.9 Z - 60.11 TURBO Z<br>65.12 - 79.12 TURBO Z   | 8580539<br>8564266                          |
| 6   | <b>727275</b>           | Albero sterzo completo / <i>Steering shaft assembly</i>             | ø 17/25,5<br>L=430     | 50.9 Z - 79.14 Z - 60.11 TURBO Z<br>65.12 - 79.12 TURBO Z   | 8580540                                     |
| 7   | <b>727276</b>           | Albero sterzo completo / <i>Steering shaft assembly</i>             | ø 17/25,5<br>L min=490 | 95.14 Z - 109.14 Z  | 8581856<br>8581853                          |
| 8   | <b>727277</b>           | Albero sterzo completo / <i>Steering shaft assembly</i>             | ø 17/25,5<br>L min=500 | 115.14 - 115.17 - 135.14 - 135.17<br>145.17   | 4834295<br>4786971                          |
| 9   | <b>727278</b>           | Albero sterzo completo / <i>Steering shaft assembly</i>             | ø 25,5<br>L min=500    | 175.17 - 175.24   | 4835930<br>4715668<br>4732740               |
| <h2 style="text-align: center;">2 GIUNTINI PIANTONE STERZO / STEERING JOURNALS</h2>       |                         |   |                        |   |   |
| 10  | <b>715619</b>           | Crociera per giuntino (piantone sterzo)<br><i>Universal joint</i>   | ø 23,82x61,2           |   | 5959654<br>4606993                          |
| 11  | <b>727153</b>           | Giuntino per piantone in acciaio stampato / <i>Steering journal</i> | (ø fori mm. 25)        | GAMMA "Z"<br>170/190 - 190.38 - 190.33/ .36/ .42/<br>.48 - 220.36/ .38 - 240.38 - 330PC26/<br>PAC26 - 330.26H/ .30H/ .35H U.T.                                    | 8564267<br>42552567<br>42087889<br>93163078 |
| 12  | <b>730305</b>           | Giunto elastico piantone sterzo / <i>Steering shaft strut</i>       |                        | DAILY-NEW DAILY-TURBO DAILY<br>DAILY 2000<br>35.11CNG - 49.11CNG - 59.11CNG   | 93806182                                    |
| 13  | <b>727240</b>           | Giunto piantone sterzo / <i>Steering shaft strut</i>                |                        | DAILY 2000 - 2006 - 2009<br>35C10/C11/C12/C13/C14/C15<br>40C10/C11/C12/C13/C14/C15<br>50C10/C11/C12/C13/C14/C15<br>65C10/C11/C12/C13/C14/C15<br>70C14/C15/C17/C18 | 500326440                                   |
| 14  | <b>727239</b>           | Supporto piantone sterzo / <i>Steering shaft bracket</i>            |                        | 30.8-35.8/.10-40.8/.10-49.10<br>DAILY-NEW DAILY<br>30.10-35.12-49.12-59.12 TURBO DAILY<br>35.11-49.11-59.11 DAILY CNG   | 93803481                                    |
| <h2 style="text-align: center;">3 BOCCOLE RINVIO STERZO / STEERING BUSHES</h2>            |                         |   |                        |   |   |
| 15  | <b>730926</b>           | Boccola in gomma per tirante sterzo / <i>Steering rubber bush</i>   | ø 53x80x38             | TURBO DAILY 30.10 - 35.10/.12 - 49.12<br>NEW DAILY 30.8 - 35.8/.10 - 49.10<br>DAILY CNG 35.11 - 49.11   | 93802392<br>503475012                       |
| 16  | <b>730927</b>           | Boccola in gomma per tirante sterzo / <i>Steering rubber bush</i>   | ø 40x80x38             | TURBODAILY 30.10 - 35.8 - 35.10<br>NEW DAILY 30.8 - 35.8/.10 - 40.8   | 93802391                                    |
| <h2 style="text-align: center;">4 CUFFIE PER STERZO / STEERING BOOTS</h2>                 |                         |   |                        |   |   |
| 17  | <b>730514</b>           | Cuffia per testa sterzo / <i>Dust-cover boot</i>                    |                        | Vecchi modelli / <i>Old range</i>   | 4510026                                     |
| 18  | <b>730586</b>           | Cuffia per testa sterzo U.T. / <i>Dust-cover boot</i>               |                        | Veicoli medi / <i>Medium vehicles</i>   | -   |
| 19  | <b>730587</b>           | Cuffia per testa sterzo U.T. / <i>Dust-cover boot</i>               |                        | Veicoli pesanti / <i>Heavy vehicles</i>   | -   |