

# CAMBIO / GEARBOX

## RICAMBI PER / SPARE PARTS FOR

<b>IVECO</b>	pag. 72 - 77
<b>DAF</b>	pag. 78 - 79
<b>MAN</b>	pag. 78 - 79
<b>MERCEDES</b>	pag. 78 - 79
<b>RENAULT</b>	pag. 78 - 79
<b>SCANIA</b>	pag. 78 - 79
<b>VOLVO</b>	pag. 78 - 79

1

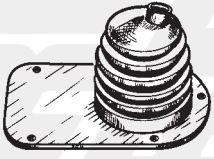

730519  
1

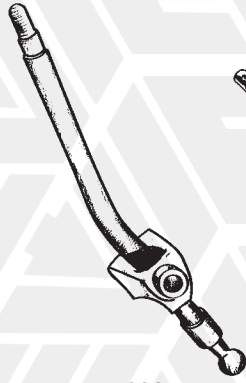

711683  
2

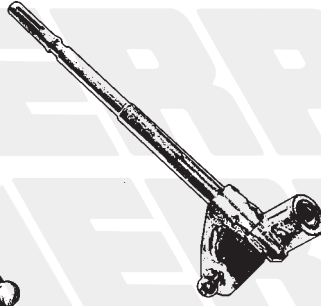

711690  
3



711692  
4



711691  
5

2



713089  
6



713097  
9



713400  
10

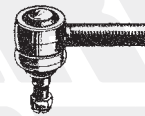

11 - 713401  
12 - 713402

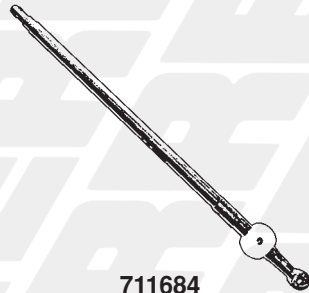

711684  
7



711685  
8

3



713096  
15

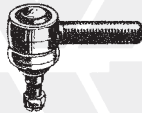

16 - 713401  
17 - 713402



713097  
18



711684  
13



711685  
14

4



715624  
19

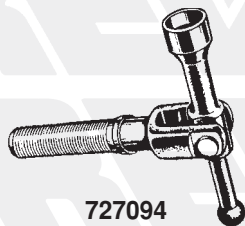

727094  
20



713096  
21



713414  
22

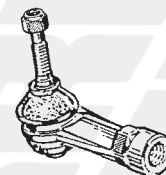

23 - 713407  
24 - 713408



713097  
25

FIG. ITEM	RIF. ERREVI ERREVI REF.	DESCRIZIONE PARTICOLARI DESCRIPTION	TIPO VEHICLE MODEL	RIF. ORIGINALE ORIGINAL REF.
-----------	-------------------------	-------------------------------------	--------------------	------------------------------

**IVECO**

**1 NEW DAILY (96) - TURBODAILY (96) - DAILY CNG - DAILY 2000**

1	<b>730519</b>	Cuffia per leva marce / <i>Dust cover boot</i>	NEW DAILY (96) TURBODAILY (96) - DAILY CNG	93911172
2	<b>711683</b>	Leva comando marce completa / <i>Gearshift lever assy</i>	NEW DAILY (96) TURBODAILY (96) - DAILY CNG	8858912 8859927
3	<b>711690</b>	Leva comando marce / <i>Gearshift lever</i>	DAILY 2000 35C9/C11/C13/C15 35S9/S11/S13/S15 50C11/C13/C15 65C13/C15	500334105
4	<b>711692</b>	Leva comando marce / <i>Gearshift lever</i>	DAILY 2000 35C9/C11/C13/C15 35S9/S11/S13/S15 50C11/C13/C15 65C11/C13/C15	504040962
5	<b>711691</b>	Supporto ad innesto per leva marce / <i>Bush gear lever</i>	DAILY 2000 35C9/C11/C13/C15 35S9/S11/S13/S15 50C11/C13/C15 65C11/C13/C15	500334104 504040961

**2 35/40NC - 45NC - 50NC - 55NC - 65NC - 70NC - 75NC  
50.8/F8 - 50.9/F9 - 50.10/F10 - 55.8/F8 - 55.10/F10  
50.9Z - 65.9Z - 60.8/F8 - 60.10/F10 - 60.11 TURBO Z - 65.10/F10 - 70.10/F10 - 79.10/F10**

6	<b>713089</b>	Giuntino elastico per tirante marce / <i>Rod coupling</i>		8564607
7	<b>711684</b>	Leva comando marce completa / <i>Gearshift lever assy</i>	50.9 Z - 65.9 Z - 60.11 TURBO Z	8594978
8	<b>711685</b>	Leva comando marce completa / <i>Gearshift lever assy</i>	50.9 Z - 60.11 TURBO Z	8594974
9	<b>713097</b>	Testina snodo per manicotto tirante / <i>Ball joint</i>	M16x1,5	8558220
10	<b>713400</b>	Testina a snodo per leva marce / <i>Ball joint</i>		8564527
11	<b>713401</b>	Testina a snodo per tirante cambio lato ant. / <i>Ball joint</i>	M16x1,5	8578493
12	<b>713402</b>	Testina a snodo per tirante cambio lato post. / <i>Ball joint</i>	M14x1,5	8578493 8582313

**3 65.12 TURBO Z - 79.12 TURBO Z - 79.13/F13 - 79.14 - 79.14Z - 80.13/F13 - 90.13/F13  
95.14/14Z - 100.13/F13 - 109.14/14Z**

13	<b>711684</b>	Leva comando marce completa / <i>Gearshift lever assy</i>	65.12 TURBO Z 79.14 Z - 79.12 TURBO Z	8594978
14	<b>711685</b>	Leva comando marce completa / <i>Gearshift lever assy</i>	65.12 TURBO Z 79.14 Z - 79.12 TURBO Z 95.14 Z - 109.14 Z	8594974
15	<b>713096</b>	Testina snodo per tirante marce / <i>Ball joint</i>	M14x1,5 79.13/F13	8550139
16	<b>713401</b>	Testina a snodo per tirante cambio lato ant. / <i>Ball joint</i>	M16x1,5 65.12 TURBO Z - 79.14/.14Z	8578492
17	<b>713402</b>	Testina a snodo per tirante cambio lato post. / <i>Ball joint</i>	M14x1,5 65.12 TURBO Z 79.12 TURBO Z - 79.14/.14Z 95.14/.14Z - 109.14/.14Z	8578493 8582313
18	<b>713097</b>	Testina snodo per manicotto tirante / <i>Ball joint</i>	M16x1,5 79.13/F13 - 80.13/F13 - 90.13/F13 100.13/F13	8558220

**4 110.14 - 115.14/ .17 - 120.13 - 135.14/ .17 - 145.17 - 175.17 - 175.24  
80NC - 90NC - 110NC - 645/650N3 - 130NC**

19	<b>715624</b>	Crociera per giuntino post. comando marce / <i>Cross joint</i>	115.14 - 115.17 - 135.14 - 135.17	4697583 4697584
20	<b>727094</b>	Leva con snodi comando articolazione / <i>Fork</i>	110.14 - 120.13	4634735
21	<b>713096</b>	Testina snodo per tirante marce / <i>Ball joint</i> - Cambio FIAT	M14x1,5 115.14 - 115.17 - 135.14 - 135.17	8550139
22	<b>713414</b>	Testina snodo per tirante marce - CAMBIO ZF - <i>Ball joint (ZF-G/box)</i>	M14x1,5 115.14 - 115.17 - 135.14 - 135.17	4345786 7981909 86027074
23	<b>713407</b>	Testina a snodo asta com. interno - CAMBIO ZF - <i>Ball joint (ZF-G/box)</i>	Fil. gambo M12x1,75 S 175.24	8198187
24	<b>713408</b>	Testina a snodo asta com. interno - CAMBIO ZF - <i>Ball joint (ZF-G/box)</i>	Fil. gambo M12x1,75 D 175.24	8198188
25	<b>713097</b>	Testina snodo per tirante marce / <i>Ball joint</i>	M16x1,5 80NC - 90NC	8558220

1

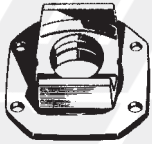

716051  
5



730501  
1



732008  
2



726858  
3



726859  
4



729502  
6



730103  
7



730104  
8

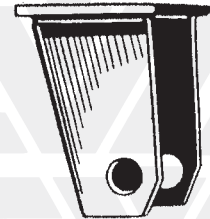

9 - 725112 Dx / RH  
10 - 725113 Sx / LH

2



11 - 715623  
12 - 715624 (E100)

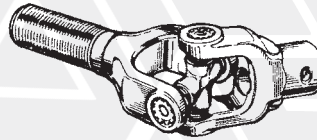

727168  
13



727198  
16



716048  
17



730103  
18

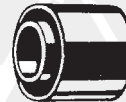

730104  
19



14 - 712029 G.D. / RHD  
15 - 711648 G.S. / LHD

3



715624  
20

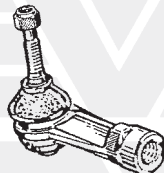

22 - 713407  
23 - 713408

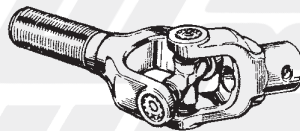

727168  
21



713414  
24



713416  
25



713204  
26



27 - 713410 (Fil. gambo Sx / Stem thread LH 10x1,5)  
28 - 713411 (Fil. gambo Dx / Stem thread RH 10x1,5)

FIG. ITEM	RIF. ERREVI ERREVI REF.	DESCRIZIONE PARTICOLARI DESCRIPTION	TIPO VEHICLE MODEL	RIF. ORIGINALE ORIGINAL REF.
<b>1 682N3/N4</b>				
1	<b>730501</b>	Cuffia parapolvere / <i>Boot</i>		842597
2	<b>732008</b>	Molla per leva / <i>Spring</i>		761086
3	<b>726858</b>	Scodellino sup. per molla / <i>Lever cap, top</i>		4520776
4	<b>726859</b>	Scodellino inf. per molla / <i>Lever cap, bottom</i>		745211
5	<b>716051</b>	Supporto per leva / <i>Mounting plate</i>		745205
6	<b>729502</b>	Dado per albero primario e secondario / <i>Mainshaft nut</i>	M50x1,5	4512211
7	<b>730103</b>	Silentblock sostegno ant. cambio / <i>Silentblock, front</i>	ø 20x52x86	606217
8	<b>730104</b>	Silentblock sostegno post. cambio / <i>Silentblock, rear</i>	ø 32x56x55	606218
9	<b>725112</b>	Supporto al telaio sostegno post. cambio Dx <i>Mounting bracket RH</i>		850038
10	<b>725113</b>	Supporto al telaio sostegno post. cambio Sx <i>Mounting bracket LH</i>		850068
<b>2 619N1 - 300 - 160NC/.26 - 170/190NC26</b>				
11	<b>715623</b>	Crociera c/cuscinetti per giunto tirante cambio <i>Complete spider</i>		4193733 7600811
12	<b>715624</b>	Crociera c/cuscinetti per giunto tirante cambio (cambio E100) <i>Complete spider (gearbox type E100)</i>		4697583 4697584
13	<b>727168</b>	Giuntino per tirante comando cambio U.T. (cambio E100) <i>Ball joint coupling (gearbox type E100)</i>	619N1 - 300	4725393
14	<b>712029</b>	Leva comando marce G.D. / <i>Gearshift lever RHD</i>	619N1 - 300	4648749 4695816
15	<b>711648</b>	Leva comando marce G.S. / <i>Gearshift lever LHD</i>	619N1 - 300	4695828
16	<b>727198</b>	Settore supporto leva marce - 2ª Serie (Guida Destra) <i>Shifting bracket RHD</i>	foro ø 8 hole ø 8 mm	4683704
17	<b>716048</b>	Supporto settore leva marce / <i>Selector bracket</i>		4663102
18	<b>730103</b>	Silentblock sostegno ant. cambio / <i>Silentblock, front</i>	ø 20x52x86	693 - 619 - 300 - 180NC 114913
19	<b>730104</b>	Silentblock sostegno post. cambio / <i>Silentblock, rear</i>	ø 32x56x55	693 - 619 - 300 - 180NC 606218
<b>3 170/190F26 - .26 - 180.24/.26 - 190i26/ i35 190.30/.38 - 190.33/.36/.42 /.48 TURBOSTAR 220F35T - 220.38PT - 240.30/.38 - 260.32/ .36 TURBOTECH 330.26H/ .30H/ .35H/ .36H</b>				
20	<b>715624</b>	Crociera completa per giuntino tirante / <i>Complete spider</i>		4697583 4697584
21	<b>727168</b>	Giuntino per tirante comando cambio / <i>Ball joint</i>		4725393
22	<b>713407</b>	Testina a snodo asta com. interno - CAMBIO ZF <i>Ball joint (ZF - G/box)</i>	Fil. gambo/ <i>Stem thread</i> M12x1,75 Sx / LH	2964495 8198187 42485638
23	<b>713408</b>	Testina a snodo asta com. interno - CAMBIO ZF <i>Ball joint (ZF - G/box)</i>	Fil. gambo/ <i>Stem thread</i> M12x1,75 Dx / RH	2964494 8198188 42485639
24	<b>713414</b>	Testina a snodo tirante selezione marce / <i>Ball joint</i>	M14x1,5	4345786 7981909 86027074
25	<b>713416</b>	Snodo per tirante leva marce / <i>Tie-rod joint</i>		42009089 42065857 42072495
26	<b>713204</b>	Testina articolazione tirante cambio / <i>Ball joint</i>	M16x1,5	41218482 42042912
27	<b>713410</b>	Testina per asta di comando Filetto Sx / <i>Ball joint LH thread</i>	M10x1,5	190.30H - 330.26H/ .30H/ .35H 42079837
28	<b>713411</b>	Testina per asta di comando Filetto Dx / <i>Ball joint RH thread</i>	M10x1,5	190.30H - 330.26H/ .30H/ .35H 42079838

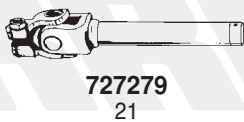
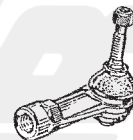
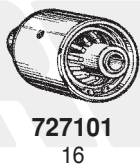
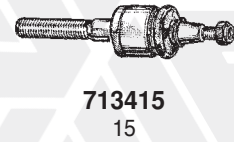
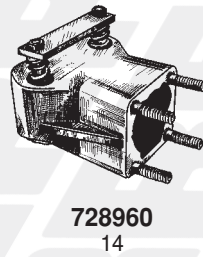
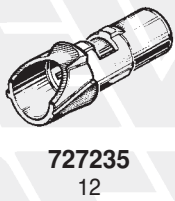
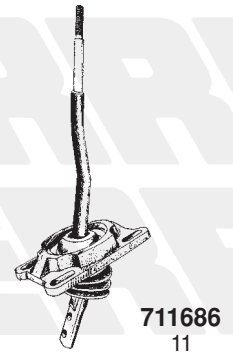
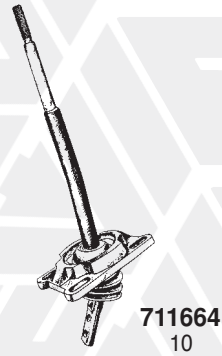
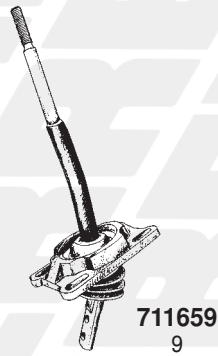
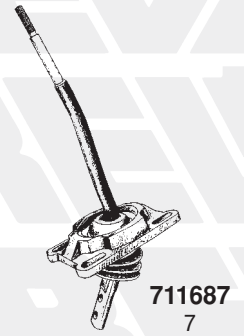
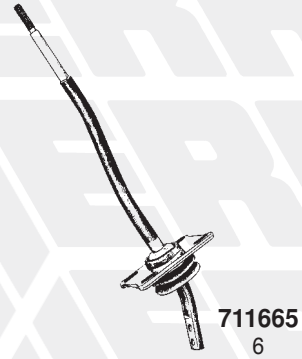
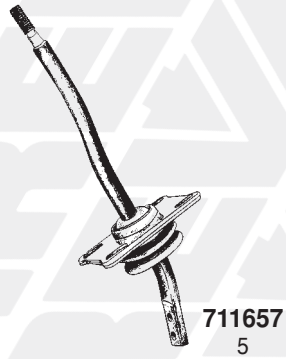
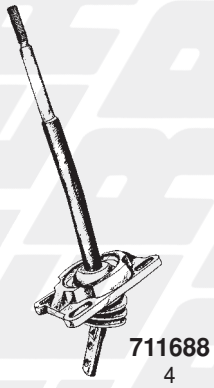
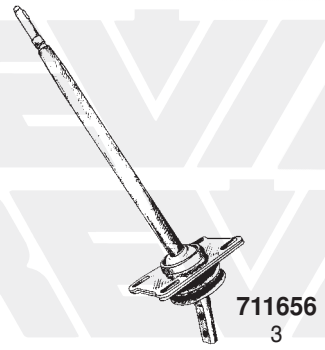
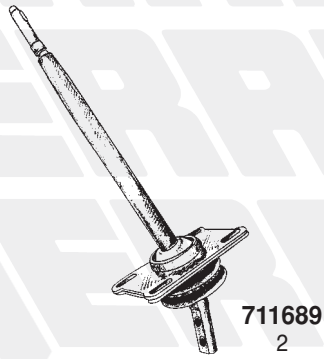
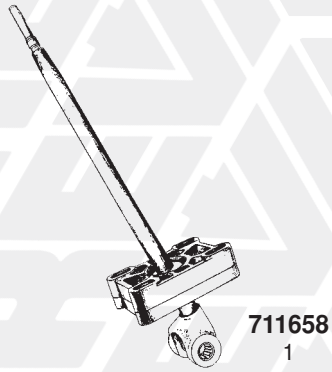

**NEW**

FIG. ITEM	RIF. ERREVI ERREVI REF.	DESCRIZIONE PARTICOLARI DESCRIPTION	TIPO VEHICLE MODEL	RIF. ORIGINALE ORIGINAL REF.
<b>EUROCARGO - EUROCARGO "TECTOR" EUROTECH - EUROTECH "CURSOR" - EUROSTAR - EUROSTAR "CURSOR" EUROTRAKKER - EUROTRAKKER "CURSOR" - TRAKKER - STRALIS</b>				
1	<b>711658</b>	Leva comando marce completa / <i>Gearshift lever assy</i>	EUROCARGO	4840325
2	<b>711689</b>	Leva comando marce completa / <i>Gearshift lever assy</i>	EUROCARGO EUROCARGO "TECTOR"	99465844 504052761
3	<b>711656</b>	Leva comando marce completa / <i>Gearshift lever assy</i>	EUROCARGO EUROCARGO "TECTOR"	99465843 504052760
4	<b>711688</b>	Leva comando marce completa / <i>Gearshift lever assy</i>	EUROTECH "CURSOR" 190E31-260E31-440E31 EUROTRAKKER EUROTRAKKER "CURSOR"	41226954 41271991
5	<b>711657</b>	Leva comando marce completa / <i>Gearshift lever assy</i>	EUROTECH 180E30/E34/E38 400E30/E34/E38/E42 EUROSTAR 400E42 EUROTRAKKER 190E31/E34 - 400E31 260E34/E37/E42 380E31/E37/E42 - 720E31/E37/E42	41001730
6	<b>711665</b>	Leva comando marce completa / <i>Gearshift lever assy</i>	EUROSTAR 190E38/E42/E47/E52 240E38/E42/E47 260E42/E47/E52 - 400E38/E42/E52 440E38/E42/E47/E52	8139205
7	<b>711687</b>	Leva comando marce completa / <i>Gearshift lever assy</i>	EUROSTAR - EUROSTAR "CURSOR"	41210812
8	<b>711660</b>	Leva comando marce completa / <i>Gearshift lever assy</i>	EUROTECH - EUROTRAKKER	41001729
9	<b>711659</b>	Leva comando marce completa / <i>Gearshift lever assy</i>	EUROTECH - EUROTECH "CURSOR" EUROTRAKKER EUROTRAKKER "CURSOR"	41210621
10	<b>711664</b>	Leva comando marce completa / <i>Gearshift lever assy</i>	STRALIS	41033070
11	<b>711686</b>	Leva comando marce completa / <i>Gearshift lever assy</i>	STRALIS	41218362 41271992
12	<b>727235</b>	Manicotto di guida per asta leva marce <i>Guiding sleeve</i>		41011049 42016769
13	<b>727238</b>	Mozzo snodato per tubo comando cambio <i>Gearbox hub articulation</i>	EUROCARGO-EUROCARGO "TECTOR" 180E24/E27 190E24/E27 } EUROTECH 325E27	4834271
14	<b>728960</b>	Scatola supporto leva marce COMPLETA <i>Gearshift lever housing, complete</i>	EUROCARGO - E.CARGO "TECTOR" EUROTECH - EUROTECH "CURSOR" EUROSTAR - EUROSTAR "CURSOR" EUROTRAKKER - STRALIS EUROTRAKKER "CURSOR"	41013876 42050807
15	<b>713415</b>	Snodo per tirante leva marce / <i>Tie rod joint</i>	EUROTECH - EUROTECH "CURSOR" EUROSTAR - EUROSTAR "CURSOR" EUROTRAKKER EUROTRAKKER "CURSOR"	41210795
16	<b>727101</b>	Snodo per leva rinvio tirante marce <b>U.T.</b> <i>Gearbox rod articulation</i>	EUROCARGO-EUROCARGO "TECTOR" 180E24/E27 190E24/E27 } EUROTECH 325E27	98446210 98470006 500322689
17	<b>713204</b>	Testa articolazione tirante cambio / <i>Ball joint</i>	M16x1,5	41218482 42042912
18	<b>713265</b>	Testa articolazione tirante cambio / <i>Ball joint</i>	M16x1,5	EUROTECH - EUROTRAKKER EUROTRAKKER "CURSOR" 41005523
19	<b>713405</b>	Testina per asta comando leva marce / <i>Ball joint</i>	Fil. gambo M10x1,5 Sx / LH	41203864 41288049 42041328
20	<b>713406</b>	Testina per asta comando leva marce / <i>Ball joint</i>	Fil. gambo M10x1,5 Dx / RH	41203863 41288050 42041327
21	<b>727279</b>	Tirante snodato / <i>Gear box joint</i>	EUROTECH - EUROSTAR EUROTRAKKER - STRALIS EUROTECH "CURSOR" EUROSTAR "CURSOR" EUROTRAKKER "CURSOR"	8132189

# 1 DAF

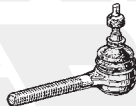

713414

1

**NEW**

# 2 MAN

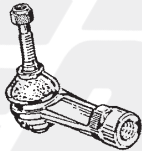

2 - 713407 (Fil. gambo Sx / Stem thread LH 12x1,75)  
3 - 713408 (Fil. gambo Dx / Stem thread RH 12x1,75)



713414

4

**NEW**

# 3 MERCEDES

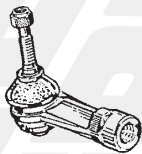

5 - 713407 (Fil. gambo Sx / Stem thread LH 12x1,75)  
6 - 713408 (Fil. gambo Dx / Stem thread RH 12x1,75)



713414

7

**NEW**

# 4 RENAULT



713414

8

**NEW**

# 5 SCANIA



9 - 711694

10 - 711695

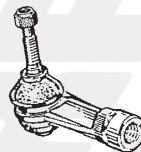

11 - 713407 (Fil. gambo Sx / Stem thread LH 12x1,75)  
12 - 713408 (Fil. gambo Dx / Stem thread RH 12x1,75)

# 6 VOLVO

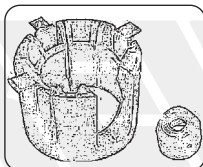

727105

13

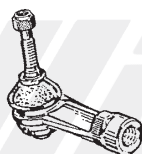

14 - 713407 (Fil. gambo Sx / Stem thread LH 12x1,75)  
15 - 713408 (Fil. gambo Dx / Stem thread RH 12x1,75)



713414

16

**NEW**



FIG. ITEM	RIF. ERREVI ERREVI REF.	DESCRIZIONE PARTICOLARI DESCRIPTION		TIPO VEHICLE MODEL	RIF. ORIGINALE ORIGINAL REF.
<b>1 DAF</b>					
1	<b>713414</b>	Testina a snodo tirante selezione marce / <i>Ball Joint</i>	M14x1,5 R / L: 86	E65CF - 75CF - 85CF - 95XF CF75 - CF85 - LF45 - LF55 XF95 - XF105	0386930
<b>2 MAN</b>					
2	<b>713407</b>	Testina a snodo per tirante comando cambio <i>Ball joint LH thread</i>	M12x1,75 <b>S / LH</b>	12170/92 - 19240 - 20240 22192/240/280 - 26240/280/32	81953016063 81953016131 81953016171 81953016174
3	<b>713408</b>	Testina a snodo per tirante comando cambio <i>Ball joint RH thread</i>	M12x1,75 <b>D / RH</b>	12170/92 - 19240 - 20240 22192/240/280 - 26240/280/320	81953016064 81953016130 81953016170 81953016173
4	<b>713414</b>	Testina a snodo tirante selezione marce / <i>Ball Joint</i>	M14x1,5 R / L: 86	M90 - TGA	81953010038 81953016016 81953016169 81953016172 81953016176 81953016235 81953016266 81953016302
<b>3 MERCEDES</b>					
5	<b>713407</b>	Testina a snodo per tirante comando cambio <i>Ball joint LH thread</i>	M12x1,75 <b>Sx / LH</b>	BM710 - BM711 - BM717 - BM719	2684789 2686189
6	<b>713408</b>	Testina a snodo per tirante comando cambio <i>Ball joint RH thread</i>	M 12x1,75 <b>Dx / RH</b>	BM710 - BM711 - BM717 - BM719	2684689 2686289
7	<b>713414</b>	Testina a snodo tirante selezione marce / <i>Ball Joint</i>	M14x1,5 R / L: 86	Serie SK-NG-OF Series	0002680189 0002684889 0023162046
<b>4 RENAULT</b>					
8	<b>713414</b>	Testina a snodo tirante selezione marce / <i>Ball Joint</i>	M14x1,5 R / L: 86	Serie C - G - J Series KERAX - MAGNUM - MANAGER MAXTER MIDLINER - MIDLUM - PREMIUM	5000516214 5010144543
<b>5 SCANIA</b>					
9	<b>711694</b>	Leva comando marce / <i>Gearshift lever</i>		94 - 114 - 124 - 144 - 164	1472771
10	<b>711695</b>	Leva comando marce / <i>Gearshift lever</i>		94 - 114 - 124 - 144 - 164	1355272 1379621
11	<b>713407</b>	Testina a snodo per tirante comando cambio <i>Ball joint LH thread</i>	M12x1,75 <b>Sx / LH</b>	Tutti i Tipi / <i>All models</i>	371451
12	<b>713408</b>	Testina a snodo per tirante comando cambio <i>Ball joint RH thread</i>	M 12x1,75 <b>Dx / RH</b>	Tutti i Tipi / <i>All models</i>	371452
<b>6 VOLVO</b>					
13	<b>727105</b>	Kit sede sfera leva cambio <i>Gearshift bush set</i>		FM9 - FM12 - FH12	8171931 8171932
14	<b>713407</b>	Testina a snodo per tirante comando cambio <i>Ball joint LH thread</i>	M12x1,75 <b>Sx / LH</b>	F4 - F6 - F10 - FL4 - FL6 - F12 FH12 - F16 - FH16 - N12	1696684
15	<b>713408</b>	Testina a snodo per tirante comando cambio <i>Ball joint RH thread</i>	M 12x1,75 <b>Dx / RH</b>	F4 - F6 - F10 - FL4 - FL6 - F12 FH12 - F16 - FH16 - N12	1696685
16	<b>713414</b>	Testina a snodo tirante selezione marce / <i>Ball Joint</i>	M14x1,5 R / L: 86	B7 - FL6 - FS7	6853913