

# RICAMBI VARI PER MOTRICI, RIMORCHI E SEMIRIMORCHI

## TRUCKS, TRAILERS AND SEMITRAILERS

### MISCELLANEOUS PARTS

#### RICAMBI PER / SPARE PARTS FOR

<b>GANCIO TRAINO PER VEICOLI PESANTI TOWING COUPLING ASSY FOR HEAVY-DUTY VEHICLES</b>	pag. 538 - 539
<b>RICAMBI PER RALLE SEMIRIMORCHI / FIFTH WHEEL ACCESSORIES</b>	pag. 540 - 541
<b>PERNI ANCORAGGIO SEMIRIMORCHI / SEMITRAILER KING PINS</b>	pag. 540 - 541
<b>CILINDRI FRENO / BRAKE CHAMBERS</b>	pag. 542 - 549
<b>IMPIANTI FRENO / AIR BRAKE PARTS</b>	pag. 550 - 551
<b>SEMIGIUNTI ACCOPPIAMENTO / AIR COUPLINGS</b>	pag. 552 - 553
<b>TUBI DI COLLEGAMENTO PNEUMATICI / AIR BRAKE COILS</b>	pag. 552 - 553
<b>COLLEGAMENTI ELETTRICI / ELECTRICAL COILS, PLUGS AND SOCKETS</b>	pag. 554 - 555
<b>TUBI FLESSIBILI ARIA / AIR FLEXIBLE TUBES</b>	pag. 554 - 555
<b>CALZATOIE / WHEEL CHOCKS</b>	pag. 554 - 555
<b>TIRANTI AGGANCO PARAFANGO E COPRIPEDALI FRENO E FRIZIONE STRAP MUDGUARD TENSIONERS AND BRAKES AND CLUTCHS PEDAL PADS</b>	pag. 556
<b>FASCETTE DI FISSAGGIO / CLAMPS</b>	pag. 557
<b>RIVETTI PER CEPPI FRENO / BRAKE LINING RIVETS</b>	pag. 558
<b>INGRASSATORI / GREASE FITTINGS</b>	pag. 559
<b>STAFFE VARIE / U BOLTS</b>	pag. 559

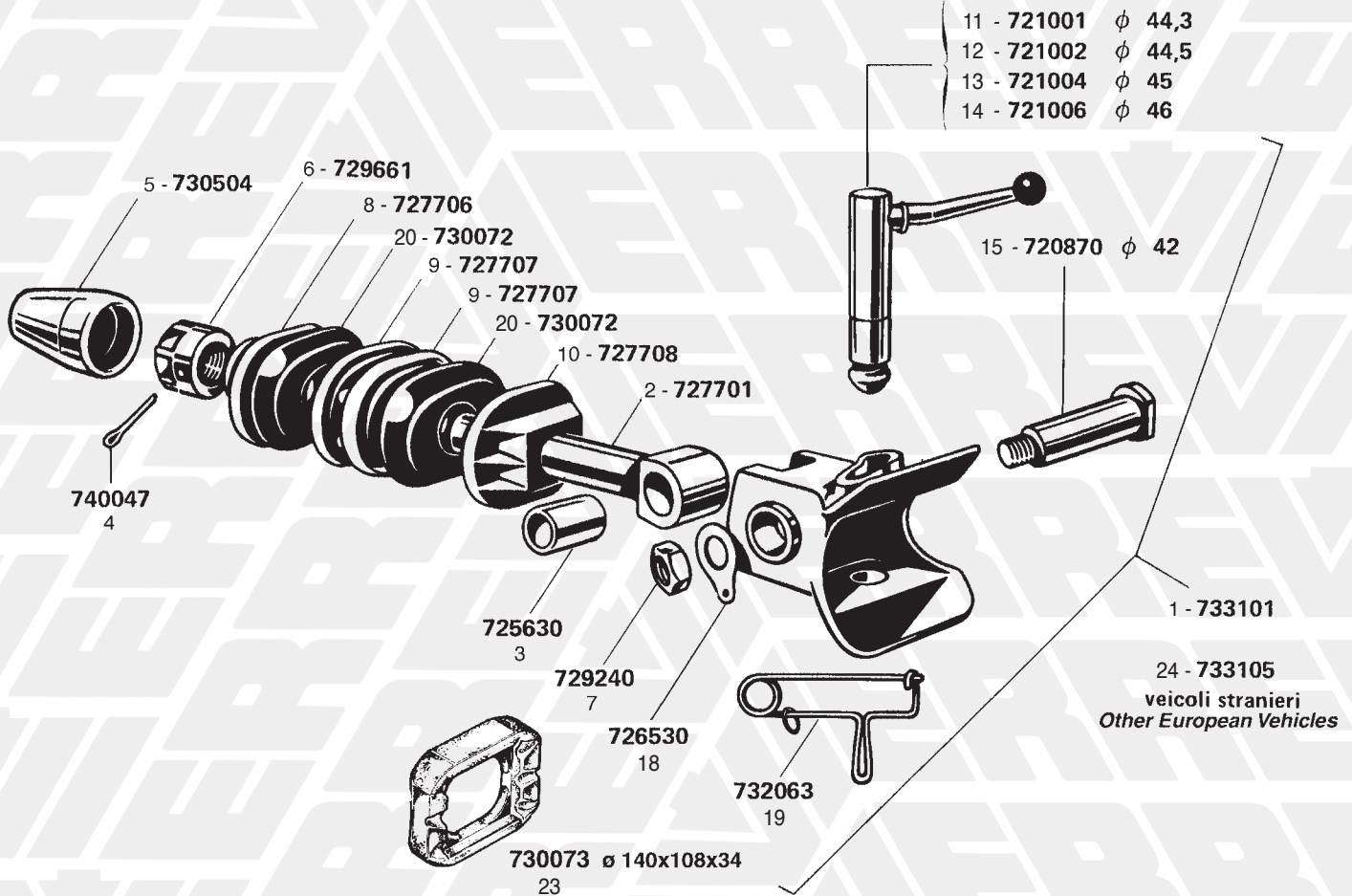
**1****GANCIO TRAINO PER VEICOLI PESANTI  
TOWING COUPLING ASSY FOR HEAVY-DUTY VEHICLES**

Perni e albero sono contrassegnati con il nostro marchio  come da approvazione Ministeriale  
 Pins and shaft bear our Logo  as per the Ministry Approval

**PARTICOLARI VARIANTI PER TIPO AUTOMATICO  
MISCELLANEOUS PARTS FOR AUTOMATHIC TYPE ONLY****2****GANCIO TRAINO AUTOMATICO  
AUTOMATIC TOWING COUPLING  
tipo RINGFEDER  
RINGFEDER TYPE****3****GANCIO TRAINO / TOWING COUPLING  
EUROTECH - EUROSTAR - EUROTRAKKER**

FIG. ITEM	RIF. ERREVI ERREVI REF.	DESCRIZIONE PARTICOLARI DESCRIPTION	TIPO VEHICLE MODEL	RIF. ORIGINALE ORIGINAL REF.
<b>1</b> <b>Gancio di traino ERREVI tipo 733101 per Autoveicoli pesanti 26tJV - CAT. V</b> <b>(Tab. CUNA-NC 138-55) D.G.M. 48494 idoneo per rimorchi di massa complessiva fino a 26 t</b> <b>Approvato dal Ministero dei Trasporti M.C.T.C.</b> <b>ERREVI Towing coupling 733101 type for Heavy-Duty Vehicles suitable for trailers up to 26 Tons</b> <b>(Approved by the Board of Transport)</b>				
1	<b>733101</b>	Gancio traino completo / <i>Towing coupling assy</i>		8518952
2	<b>727701</b>	Albero del gancio / <i>Shaft</i>	ø 50x285	8518958
3	<b>725630</b>	Boccola per perno trasversale in lega xantal / <i>Bush</i>	ø 42x46x90	8519209
4	<b>740047</b>	Copiglia per dado albero / <i>Cotter pin</i>		10797701 30000828
5	<b>730504</b>	Cuffia parapolvere per dado / <i>Dustcover boot</i>		8519240
6	<b>729661</b>	Dado per albero del gancio / <i>Shaft nut</i>	M45x3 H=55	8518957
7	<b>729240</b>	Dado per perno trasversale / <i>Pin nut</i>	M30x2 H=21	8518983
8	<b>727706</b>	Flangia anteriore / <i>Flange, front</i>		8518955
9	<b>727707</b>	Flangia intermedia / <i>Flange, intermediate</i>		4618267 8518956
10	<b>727708</b>	Flangia posteriore / <i>Flange, rear</i>		8519203
11	<b>721001</b>	Perno a manetta normale / <i>Tow-hook pintle STD</i>	ø 44.3	8518954
12	<b>721002</b>	Perno a manetta magg. / <i>Tow-hook pintle O/S</i>	ø 44.5	-
13	<b>721004</b>	Perno a manetta magg. / <i>Tow-hook pintle O/S</i>	ø 45	-
14	<b>721006</b>	Perno a manetta magg. / <i>Tow-hook pintle O/S</i>	ø 46	-
15	<b>720870</b>	Perno trasversale per testa c/dado / <i>Trasversal pin</i>	ø 42x166	8525377 8518959
16	<b>726532</b>	Rondella spessore per perno trasversale / <i>Trasversal pin washer</i>	ø 42x68x0.6	-
17	<b>726531</b>	Rondella spessore per perno trasversale / <i>Trasversal pin washer</i>	ø 42x68x1	-
18	<b>726530</b>	Rondella p/dado perno trasversale / <i>Retaining washer</i>	ø 31x58x2	7984319 8525378
19	<b>732063</b>	Spilla di sicurezza / <i>Safety pin</i>		8518960
20	<b>730072</b>	Tampone elastico in gomma / <i>Rubber pad</i>	168x115x57	7984332 8786473
<b>PARTICOLARI VARIANTI PER TIPO AUTOMATICO</b> <b>MISCELLANEOUS PARTS FOR AUTOMATHIC TYPE ONLY</b>				
21	<b>727096</b>	Chiavistello per sganciamento perno / <i>Latch pin</i>		1541/16504/B
22	<b>727097</b>	Leva di sicurezza per chiavistello / <i>Latch lever</i>		1542/16506/C
23	<b>730073</b>	Tassello in gomma appoggio campana / <i>Rubber pad</i>	ø 140x108x34	18585/C
<b>VEICOLI PESANTI STRANIERI</b> <b>OTHER EUROPEAN HEAVY-DUTY VEHICLES</b>				
24	<b>733105</b>	Gancio traino completo / <i>Towing coupling assy</i>		-
25	<b>727709</b>	Flangia intermedia / <i>Intermediate flange</i>		8198725
		I rimanenti particolari sono intercambiabili con i tipi nazionali. <i>All other parts are interchangeable with Italian models.</i>		
<b>2</b> <b>GANCIO TRAINO AUTOMATICO TIPO RINGFEDER</b> <b>AUTOMATIC TOWING COUPLING RINGFEDER TYPE</b>				
26	<b>726094</b>	Boccola per occhione gancio automatico <i>Tow-eye bush automatic towing coupling</i>	ø 50x60,3x44	10998298
<b>3</b> <b>GANCIO TRAINO / TOWING COUPLING</b> <b>EUROTECH - EUROSTAR - EUROTRAKKER</b>				
27	<b>727704</b>	Albero del gancio completo di boccola senza dado <i>Shaft c/w bush, without nut</i>	ø 50x260	42535190
28	<b>725820</b>	Boccola per perno trasversale con RAGNATURA <i>Grooved bush</i>	ø 42x46x90	42533762 42533729
29	<b>730074</b>	Tampone el. in gomma - Flangia post. / <i>Rubber pad - Rear flange</i>	ø 168x115x36	93190910
30	<b>730075</b>	Tampone el. in gomma - Flangia ant. / <i>Rubber pad - Front flange</i>	ø 168x115x55	93190909
31	<b>730076</b>	Tampone elastico in gomma appoggio campana / <i>Rubber pad</i>	ø 140x110x26	42532593

# 1 RICAMBI PER RALLE SEMIRIMORCHI / FIFTH WHEEL ACCESSORIES



711944  
8

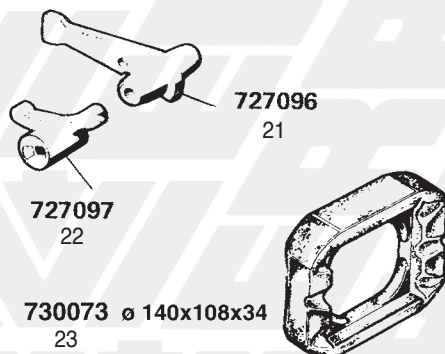
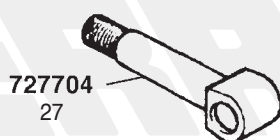
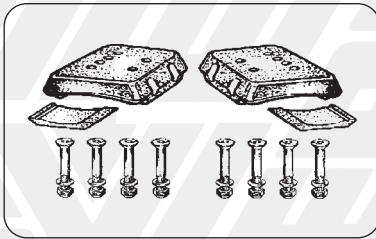
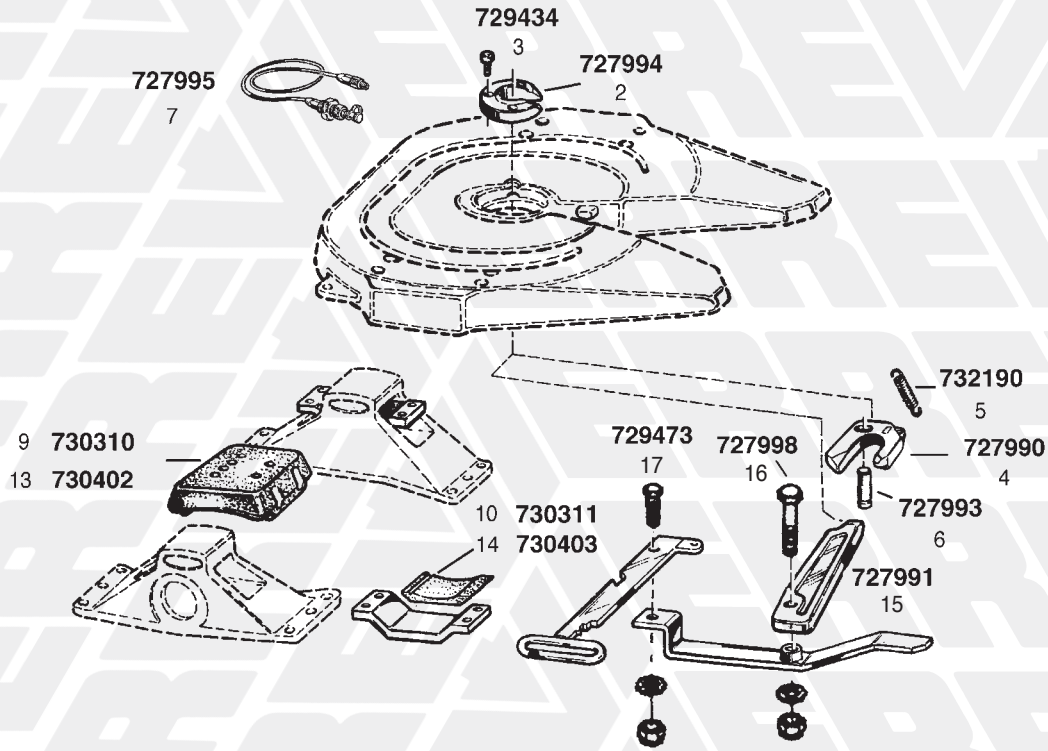
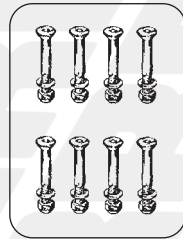

711978  
11

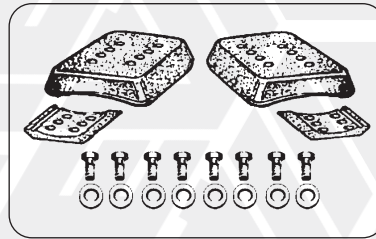

711974  
12

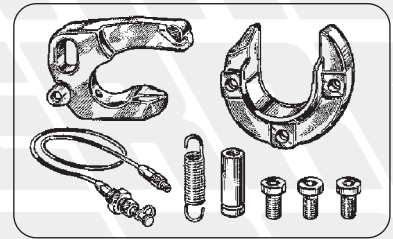

711945  
1

# 2 PERNI ANCORAGGIO SEMIRIMORCHI / SEMITRAILER KING PIN



725821  
18

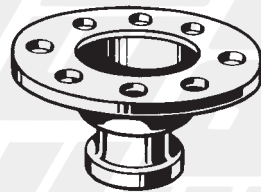

720820  
19

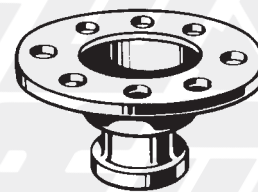

20 - 720819 con fori svasati



729475  
23

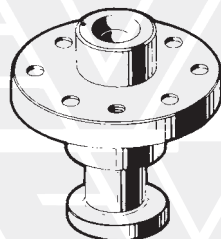

720806  
21

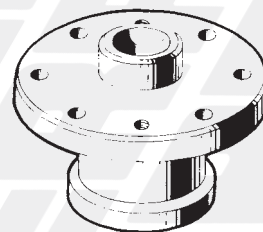

720818  
22

FIG. ITEM	RIF. ERREVI ERREVI REF.	DESCRIZIONE PARTICOLARI DESCRIPTION	TIPO VEHICLE MODEL	RIF. ORIGINALE ORIGINAL REF.
<b>1 RICAMBI PER RALLE SEMIRIMORCHI / FIFTH WHEEL ACCESSORIES</b> <b>INTERCAMBIABILE CON TIPO JOST / INTERCHANGEABLE WITH JOST TYPE</b> <b>JSK 36 DA/DV - JSK 37 C/CW/E/EW/EA/EAW/ER/ERW - JSK 38</b>				
1	<b>711945</b>	<b>Kit riparazione ralla composto da:</b> <b>Fifth wheel jaw reair kit complete with:</b>	JSK 37 C/E/EA/ER	SK 3221-50 Z
2	<b>727994</b>	(1) Anello di usura / <i>Wear ring</i>	JSK 36 DA/DV - JSK 37 C/E/EA/ER	SK 2105-19
3	<b>729434</b>	(3) Bullone fiss. anello di usura / <i>Wear ring bolt</i>	M14x2 L=24 JSK 36 DA/DV - JSK 37 C/E/EA/ER	SK 2121-07
4	<b>727990</b>	(1) Ganascia di bloccaggio / <i>Jaw</i>	JSK 37 C/CW/E/EW/EA/EAW/ER/ERW	SK 1489 Z
5	<b>732190</b>	(1) Molla per ganascia / <i>Jaw spring</i>	JSK 36 DA/DV JSK 37 C/CW/E/EW/EA/EAW/ER/ERW	SK 847
6	<b>727993</b>	(1) Perno per ganascia / <i>Pivot pin</i>	ø 20x65 JSK 36 DA/DV JSK 37 C/CW/E/EW/EA/EAW/ER/ERW	SK 2106-67
7	<b>727995</b>	(1) Kit ingrassatore / <i>Grease fitting kit</i>	JSK 37 C/CW/E/EW/EA/EAW/ER/ERW	SK 3108-02
8	<b>711944</b>	<b>Kit tamponi sostegno composto da:</b> <b>Rubber pad kit complete with:</b>	JSK 37 C/CW	SK 2121-69
9	<b>730310</b>	(2) Tampone in gomma sup. / <i>Rubber pad, top</i>	JSK 37 C/CW	SK 1259
10	<b>730311</b>	(2) Tampone in gomma inf. / <i>Rubber pad, bottom</i>	JSK 37 C/CW	SK 2105-25
11	<b>711978</b>	Kit bulloni testa svasata (8 pz.) / <i>Countersunk bolts kit (8 pcs.)</i>	M16x100 JSK 37 C/CW	SK 2121-15
12	<b>711974</b>	<b>Kit tamponi sostegno composto da:</b> <b>Rubber pad kit complete with:</b>	JSK 38	SK 2421-78
13	<b>730402</b>	(2) Tampone in gomma sup. / <i>Rubber pad, top</i>	JSK 38	SK 2006
14	<b>730403</b>	(2) Tampone in gomma inf. / <i>Rubber pad, bottom</i>	JSK 38	SK 2007
		(8) Bullone / <i>Bolt</i>	JSK 38	-
		(8) Rondella / <i>Washer</i>	JSK 38	-
15	<b>727991</b>	Chiavistello di bloccaggio / <i>Latch</i>	JSK 37 C/CW/E/EW/EA/EAW/ER/ERW	SK 3205-06
16	<b>727998</b>	Perno per chiavistello completo / <i>Latch pin complete</i>	ø 20x95 JSK 37 C/CW/E/EW/EA/EAW/ER/ERW	SK 3221-01
17	<b>729473</b>	Vite con rondella e dado / <i>Bolt with washer and nut</i>	JSK 36 DA/DV JSK 37 C/CW/E/EW/EA/EAW/ER/ERW	SK 1513
<b>2 PERNI ANCORAGGIO SEMIRIMORCHI</b> <b>SEMITRAILER KING PIN</b>				
18	<b>725821</b>	Boccola per trasformazione perni ancoraggio da 2" a 3"½ <i>Bolt-in king pin adaptor (converts 2" to 3"½)</i>		-
19	<b>720820</b>	Perno ancoraggio 2" / <i>Bolt-in king pin 2"</i>	8 fori / <i>holes</i> flangia / <i>flange</i> ø 200	VIBERTI - ADIGE JOST 112349207 KZ 1012-01
20	<b>720819</b>	Perno ancoraggio 2" / <i>Bolt-in king pin 2"</i>	8 fori svasati 8 <i>countersink</i> <i>holes</i> flangia / <i>flange</i> ø 200	JOST KZ 0912-01
21	<b>720806</b>	Perno ancoraggio 2" / <i>Bolt-in king pin 2"</i>	6 fori / <i>holes</i> flangia / <i>flange</i> ø 160	BERSAGLIERE U. PIACENZA FRANCHIN - ZORZI MINERVA 100066
22	<b>720818</b>	Perno ancoraggio 3"½ / <i>Bolt-in king pin 3"½</i>	6 fori / <i>holes</i> flangia / <i>flange</i> ø 170	BERSAGLIERE U. PIACENZA FRANCHIN - ZORZI MINERVA -
23	<b>729475</b>	Vite fissaggio perni ancoraggio / <i>King pin bolt</i>	M14x2 L=35	JOST KZE 1012-03

FIG. ITEM	RIF. ERREVI ERREVI REF.	DESCRIZIONE PARTICOLARI DESCRIPTION	TIPO VEHICLE MODEL	RIF. ORIGINALE ORIGINAL REF.
-----------	-------------------------	-------------------------------------	--------------------	------------------------------

**IMPIANTI FRENO / AIR BRAKE PARTS**

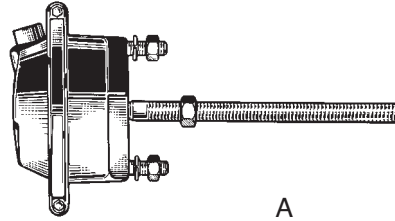

**1 CILINDRI FRENO PER FRENI A TAMBURO  
BRAKE CHAMBERS AND SPRING BRAKE ACTUATORS FOR BRAKE DRUMS**

A	<b>718290</b>	Cilindro freno / <i>Brake chamber</i> Impianto frenante <b>WABCO-KNORR Brake system</b> 4231039000 - BZ3268	12" Corsa / Stroke 75 mm	<b>DAF</b> <b>MAN</b>  <b>RENAULT</b> <b>SCANIA</b> <b>BPW</b>	BBU5929 81511016207 81511016211	1505025 81511016216 81511019203 5430053317 1932620 0544412010
A	<b>718099</b>	Cilindro freno / <i>Brake chamber</i> Impianto frenante <b>WABCO-KNORR Brake system</b> 4231049000 - BZ3374	16" Corsa / Stroke 75 mm	<b>DAF</b>  <b>MAN</b> <b>MERCEDES</b> <b>RENAULT</b> <b>SCANIA</b> <b>BPW</b>	BBU5930    1010153	0745398 0834481 81511016249 0014200924 5021170047 1912301 0544413010
A	<b>718098</b>	Cilindro freno / <i>Brake chamber</i> Impianto frenante <b>WABCO-KNORR Brake system</b> 4231059000 - BX3419	20" Corsa / Stroke 75 mm	<b>DAF</b> <b>IVECO</b> <b>MERCEDES</b> <b>RENAULT</b> <b>SCANIA</b> <b>BPW</b>	BBU5931 4676322 6984203721  0203362000	0834482 4760117 6994200724 5021170049 1738479 0544414010
A	<b>718094</b>	Cilindro freno / <i>Brake chamber</i> Impianto frenante <b>WABCO-KNORR Brake system</b> 4231069000 - BX3538	24" Corsa / Stroke 75 mm	<b>DAF</b> <b>MERCEDES</b> <b>RENAULT</b> <b>SCANIA</b> <b>VOLVO</b> <b>BPW</b>	BBU5932 0014203524  1010154 0544415010	0834483 0064201718 5021170051 1738480 6212188 0544415110
A	<b>718097</b>	Cilindro freno / <i>Brake chamber</i> Impianto frenante <b>WABCO-KNORR Brake system</b> 4231079000 - BX3607	30" Corsa / Stroke 75 mm	<b>DAF</b>  <b>RENAULT</b> <b>SCANIA</b> <b>BPW</b>	BBU5933   1010155 0544416010	0705707 0834484 5021170052 1738481 0544416110

I marchi ed i nominativi dei costruttori come pure i riferimenti originali sono esposti a solo titolo indicativo in quanto i nostri particolari non sono originali  
 Manufacturer's names and part numbers in this catalogue are used for cross reference purposes only and do not imply anything about the origin or manufacturer of product.

FIG. ITEM	RIF. ERREVI ERREVI REF.	DESCRIZIONE PARTICOLARI DESCRIPTION	TIPO VEHICLE MODEL	RIF. ORIGINALE ORIGINAL REF.
-----------	-------------------------	-------------------------------------	--------------------	------------------------------

**IMPIANTI FRENO / AIR BRAKE PARTS**

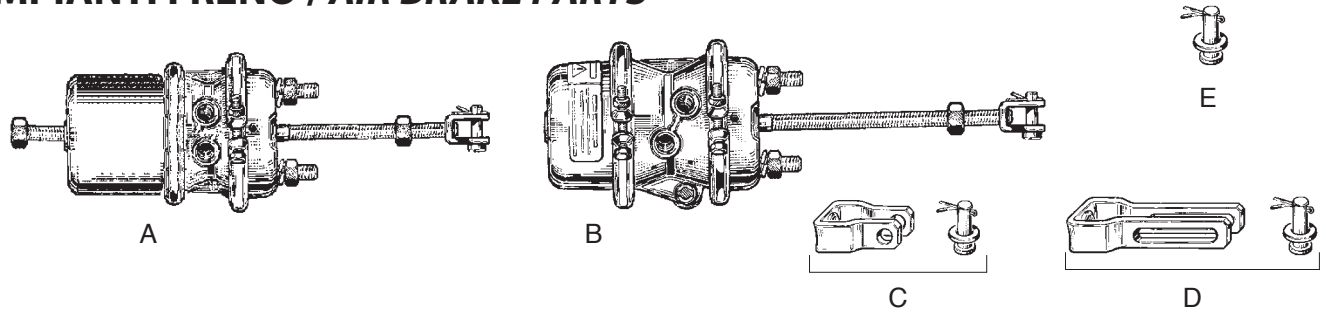

**1 CILINDRI FRENO PER FRENI A TAMBURO  
BRAKE CHAMBERS AND SPRING BRAKE ACTUATORS FOR BRAKE DRUMS**

A	<b>718299</b>	Cilindro freno attuatore / <i>Brake actuator</i> Impianto frenante <b>KNORR</b> Brake system BX7401	20 / 24" Corsa / Stroke 57 mm	<b>DAF</b>  <b>IVECO</b> <b>RENAULT</b> <b>SCANIA</b>	0878092 1384266	0905270 0905272 500037066 5021133573 2121851
A	<b>718260</b>	Cilindro freno attuatore / <i>Brake actuator</i> Impianto frenante <b>WABCO</b> Brake system 9254901020	20 / 24" Corsa / Stroke 65 mm	<b>DAF</b>	1518313	1818155
A	<b>718261</b>	Cilindro freno attuatore / <i>Brake actuator</i> Impianto frenante <b>WABCO</b> Brake system 9254911430	24 / 30" Corsa / Stroke 64 mm	<b>DAF</b>	1519444	1519187
A	<b>718262</b>	Cilindro freno attuatore / <i>Brake actuator</i> Impianto frenante <b>WABCO</b> Brake system 9254990010	27 / 30" Corsa / Stroke 65 mm	<b>RENAULT</b>		5021170342
A	<b>718263</b>	Cilindro freno attuatore / <i>Brake actuator</i> Impianto frenante <b>WABCO</b> Brake system 9254921020 - 8901103530	30 / 30" Corsa / Stroke 64 mm	<b>DAF</b>  <b>IVECO</b> <b>MAN</b>  <b>MERCEDES</b>  <b>RENAULT</b> <b>SCANIA</b>	1270262 1305170 81504106675 81504106676 0134206618	1518149 1519164 5000869541 81504106679 81504106680 0164200418 0194208518 5010067834 1935475
B	<b>718184</b>	Cilindro freno attuatore / <i>Brake actuator</i> Impianto frenante <b>KNORR</b> Brake system BX7516	24 / 24" Corsa / Stroke 64 mm	<b>DAF</b>		-
B	<b>718189</b>	Cilindro freno attuatore / <i>Brake actuator</i> Impianto frenante <b>WABCO-KNORR</b> Brake system 9253712000 - BX7515	24 / 30" Corsa / Stroke 75 mm	<b>DAF</b> <b>RENAULT</b> <b>BPW</b>  <b>SCHMITZ</b>	0203273900 0544420010	1325352 5021170326 0544420040 0544420100 050408
B	<b>718190</b>	Cilindro freno attuatore / <i>Brake actuator</i> Impianto frenante <b>WABCO-KNORR</b> Brake system 9253722000 - 9253723000 - BX7611	30 / 30" Corsa / Stroke 64 mm	<b>DAF</b> <b>RENAULT</b> <b>SCANIA</b> <b>BPW</b> <b>SAF</b>	0544421040	1325351 5021170327 1738483 0544421110 4454105800
C	<b>718180</b>	Forcellino corto con foro completo di perno <i>Yoke with pivot</i>	ø 14			-
D	<b>718181</b>	Forcellino lungo con asola completo di perno <i>Oblong yoke with pivot</i>	ø 14			-
E	<b>718166</b>	Pernetto per forcellino / <i>Pivot</i>	ø 14			-

I marchi ed i nominativi dei costruttori come pure i riferimenti originali sono esposti a solo titolo indicativo in quanto i nostri particolari non sono originali  
 Manufacturer's names and part numbers in this catalogue are used for cross reference purposes only and do not imply anything about the origin or manufacturer of product.

FIG. ITEM	RIF. ERREVI ERREVI REF.	DESCRIZIONE PARTICOLARI DESCRIPTION	TIPO VEHICLE MODEL	RIF. ORIGINALE ORIGINAL REF.
-----------	-------------------------	-------------------------------------	--------------------	------------------------------

## IMPIANTI FRENO / AIR BRAKE PARTS

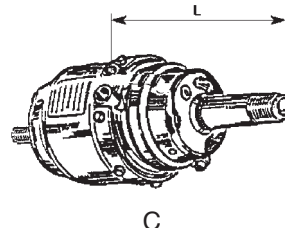
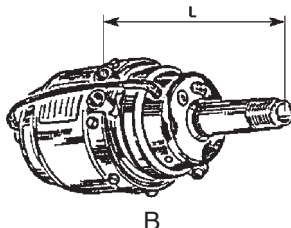
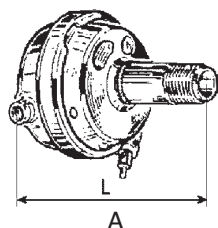
**1**

### CILINDRI FRENO PER FRENI A TAMBURO

### BRAKE CHAMBERS AND SPRING BRAKE ACTUATORS FOR BRAKE DRUMS

A	<b>718186</b>	Cilindro freno / Brake chamber Impianto frenante <b>WABCO-KNORR</b> Brake system 4231430010 - EF120P	12" L= 138 Corsa / Stroke 50 mm	<b>IVECO</b>  <b>MAN</b> <b>RENAULT</b>	4464432 4713105	42126941 92900312 N1011015187 5021170053
A	<b>718188</b>	Cilindro freno / Brake chamber Impianto frenante <b>WABCO-KNORR</b> Brake system 4231430070 - EF120L	12" L= 157 Corsa / Stroke 50 mm	<b>IVECO</b>	42066420	42066442 42070658
B	<b>718187</b>	Cilindro freno / Brake chamber Impianto frenante <b>WABCO-KNORR</b> Brake system 4253270670 - BFM121C	12" L=157 Corsa / Stroke 50 mm	<b>IVECO</b>	42070539 42071449	98446238 98446264
B	<b>718088</b>	Cilindro freno / Brake chamber Impianto frenante <b>WABCO-KNORR</b> Brake system 4253270540 - 4253270640 - BY7206 - BFM121BK	12" L=187 Corsa / Stroke 50 mm	<b>DAF</b> <b>IVECO</b>  <b>RENAULT</b>	42071450 42072532	1518655 42072536 98446217 5010118947
A	<b>718297</b>	Cilindro freno / Brake chamber Impianto frenante <b>KNORR</b> Brake system EF161DY	16" L = 168 Corsa / Stroke 55 mm	<b>ASTRA</b> <b>IVECO</b>	185905	98185905 98185905
A	<b>718298</b>	Cilindro freno / Brake chamber Impianto frenante <b>KNORR</b> Brake system EF161CY	16" L = 330 Corsa / Stroke 55 mm	<b>ASTRA</b> <b>IVECO</b>		98194985 98194985
A	<b>718296</b>	Cilindro freno / Brake chamber Impianto frenante <b>KNORR</b> Brake system EF241MY	24" L = 275 Corsa / Stroke 60 mm	<b>ASTRA</b> <b>IVECO</b>	167957	98167957 98167957
C	<b>718273</b>	Cilindro freno / Brake chamber Impianto frenante <b>WABCO-KNORR</b> Brake system 4253460020 - 4254460020 - BY9225 - BY9236 - BFM122BK	12 / 20" L=187 Corsa / Stroke 53 mm	<b>DAF</b> <b>IVECO</b>	42052855	1505955 98446265
C	<b>718295</b>	Cilindro freno / Brake chamber Impianto frenante <b>WABCO-KNORR</b> Brake system BY9205	12 / 20" L = 187 Corsa / Stroke 53 mm	<b>IVECO</b>	4835041	98403027 99446699
C	<b>718274</b>	Cilindro freno / Brake chamber Impianto frenante <b>KNORR</b> Brake system BY9250	14 / 20" L=180 Corsa / Stroke 53 mm	<b>IVECO</b>	41285147	98412993 99446702
C	<b>718275</b>	Cilindro freno / Brake chamber Impianto frenante <b>KNORR</b> Brake system BY9260	14 / 24" L=190 Corsa / Stroke 53 mm	<b>IVECO</b>		41013260
C	<b>718279</b>	Cilindro freno / Brake chamber Impianto frenante <b>KNORR</b> Brake system BY9276	14 / 24" L=190 Corsa / Stroke 64 mm	<b>IVECO</b>		41211359
C	<b>718276</b>	Cilindro freno / Brake chamber Impianto frenante <b>KNORR</b> Brake system BY9278 - BY9303	16 / 24" L=190 Corsa / Stroke 53 mm	<b>ASTRA</b> <b>IVECO</b>	41001830 41211374	- 41285149 41285150
C	<b>718280</b>	Cilindro freno / Brake chamber Impianto frenante <b>KNORR</b> Brake system BY9328	16 / 24" L=190 Corsa / Stroke 64 mm	<b>ASTRA</b> <b>IVECO</b>	41211078	41285153 41285153
C	<b>718277</b>	Cilindro freno / Brake chamber Impianto frenante <b>KNORR</b> Brake system BY9351	18 / 24" L=190 Corsa / Stroke 53 mm	<b>IVECO</b>	8169240	8189492
C	<b>718316</b>	Cilindro freno / Brake chamber Impianto frenante <b>KNORR</b> Brake system BY9401	20 / 24" L=190 Corsa / Stroke 53 mm	<b>DAF</b> <b>IVECO</b>	8137483	1520873 8169241
C	<b>718317</b>	Cilindro freno / Brake chamber Impianto frenante <b>KNORR</b> Brake system BY9451	22 / 24" L=190 Corsa / Stroke 53 mm	<b>IVECO</b>		41006333
C	<b>718278</b>	Cilindro freno / Brake chamber Impianto frenante <b>KNORR</b> Brake system BY9500	24 / 24" L=190 Corsa / Stroke 53 mm	<b>ASTRA</b> <b>IVECO</b>	8137768 8189491	115107 8189495 41015818

I marchi ed i nominativi dei costruttori come pure i riferimenti originali sono esposti a solo titolo indicativo in quanto i nostri particolari non sono originali  
 Manufacturer's names and part numbers in this catalogue are used for cross reference purposes only and do not imply anything about the origin or manufacturer of product.



FIG. ITEM	RIF. ERREVI ERREVI REF.	DESCRIZIONE PARTICOLARI DESCRIPTION	TIPO VEHICLE MODEL	RIF. ORIGINALE ORIGINAL REF.
-----------	-------------------------	-------------------------------------	--------------------	------------------------------

**IMPIANTI FRENO / AIR BRAKE PARTS**

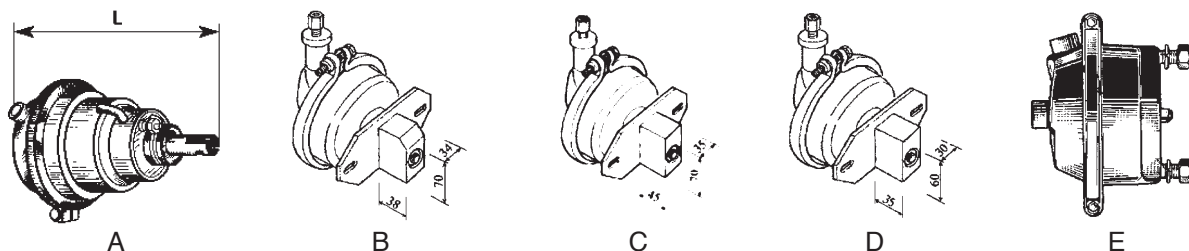

**1 CILINDRI FRENO PER FRENI A TAMBURO  
BRAKE CHAMBERS AND SPRING BRAKE ACTUATORS FOR BRAKE DRUMS**

A	<b>718267</b>	Cilindro freno / <i>Brake chamber</i> Impianto frenante <b>KNORR Brake system</b> 1186754XU	T61 Corsa / Stroke 40 mm	<b>IVECO</b>	98403527	4842679
A	<b>718266</b>	Cilindro freno / <i>Brake chamber</i> Impianto frenante <b>KNORR Brake system</b> 1186753XU	T51 Corsa / Stroke 40 mm	<b>IVECO</b>	98403526	1186753 4842678

**2 CILINDRI BLOCCAGGIO PER ASSALI STERZANTI  
STEERING AXLES DIAPHRAGM LOCKING CYLINDERS**

B	<b>718090</b>	Cilindro bloccaggio sterzante / <i>Steering locking cylinder</i> 34x70x38 - M12x1,5 Impianto frenante <b>MERITOR Brake system</b>	9" Corsa / Stroke 35 mm	<b>MERITOR - ROR</b>  <b>AUSTERAS</b>		21212472 C4232520 99361002
C	<b>718197</b>	Cilindro bloccaggio sterzante / <i>Steering locking cylinder</i> 35x70x45 - M16x1,5 Impianto frenante <b>MERITOR Brake system</b>	9" Corsa / Stroke 35 mm	<b>MERITOR - ROR</b>		21223339 C4232511
D	<b>718198</b>	Cilindro bloccaggio sterzante / <i>Steering locking cylinder</i> 30x60x35 - M12x1,5 Impianto frenante <b>MERITOR Brake system</b>	9" Corsa / Stroke 35 mm	<b>MERITOR - ROR</b>		C4232502

**3 CILINDRI FRENO PER FRENI A DISCO  
BRAKE CHAMBERS AND BRAKE ACTUATORS FOR BRAKE DISCS**

E	<b>718281</b>	Cilindro freno / <i>Brake chamber</i> Impianto frenante <b>KNORR Brake system</b> BS3260	14" Corsa / Stroke 57 mm	<b>DAF</b> <b>RENAULT</b> <b>MERITOR - ROR</b> Assale serie LM-LC <i>Axles parts</i> Disco freno ELSA 2 <i>Brake disc</i>	1489884 5021200537 41227562	1489885 5021200538 41227563
E	<b>718191</b>	Cilindro freno / <i>Brake chamber</i> Impianto frenante <b>KNORR Brake system</b> BS3300	16" Corsa / Stroke 57 mm	<b>DAF</b> <b>MERCEDES</b> <b>SCANIA</b> <b>BPW</b>  <b>SAF</b>		1505241 0064205224 1932621 0203277000 0544432010 0203277100 0544432020 4454106560 3454106560 3454108160
E	<b>718192</b>	Cilindro freno / <i>Brake chamber</i> Impianto frenante <b>KNORR Brake system</b> BS3404	20" Corsa / Stroke 64 mm	<b>DAF</b> <b>MAN</b> <b>MERCEDES</b> <b>SCANIA</b> <b>BPW</b> <b>SAF</b>		1517954 N2504016063 0074201224 1932639 0203277400 0203277500 3454106760 3454108260
E	<b>718193</b>	Cilindro freno / <i>Brake chamber</i> Impianto frenante <b>KNORR Brake system</b> BS3509	24" Corsa / Stroke 64 mm	<b>DAF</b> <b>IVECO</b> <b>MERCEDES</b> <b>SCANIA</b> <b>BPW</b> <b>SAF</b>		1517956 500590336 0074201424 1932640 0203277800 0203277900 3454106960

I marchi ed i nominativi dei costruttori come pure i riferimenti originali sono esposti a solo titolo indicativo in quanto i nostri particolari non sono originali  
 Manufacturer's names and part numbers in this catalogue are used for cross reference purposes only and do not imply anything about the origin or manufacturer of product.

FIG. ITEM	RIF. ERREVI ERREVI REF.	DESCRIZIONE PARTICOLARI DESCRIPTION	TIPO VEHICLE MODEL	RIF. ORIGINALE ORIGINAL REF.
-----------	-------------------------	-------------------------------------	--------------------	------------------------------

## IMPIANTI FRENO / AIR BRAKE PARTS

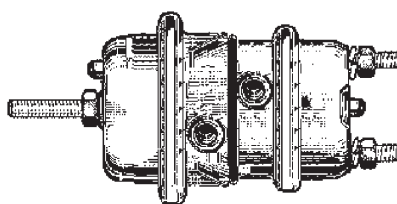

A

1

### CILINDRI FRENO PER FRENI A DISCO BRAKE CHAMBERS AND BRAKE ACTUATORS FOR BRAKE DISCS

A	<b>718268</b>	Cilindro freno attuatore Dx / Brake actuator RH Impianto frenante <b>MERITOR</b> Brake system	14 / 24" Corsa / Stroke 76 mm	<b>MERITOR - ROR</b> Assale serie LM-LC e TA-TC Axles parts Disco freno ELSA 2 Brake disc <b>MAN</b> <b>RENAULT</b>	41227567	41231074  N2504016051 7424990227
A	<b>718285</b>	Cilindro freno attuatore Sx / Brake actuator LH Impianto frenante <b>MERITOR</b> Brake system	14 / 24" Corsa / Stroke 76 mm	<b>MERITOR - ROR</b> Assale serie LM-LC e TA-TC Axles parts Disco freno ELSA 2 Brake disc <b>MAN</b> <b>RENAULT</b>	41227566	41231073  N2504016050 7424990226
A	<b>718287</b>	Cilindro freno attuatore Dx / Brake actuator RH Impianto frenante <b>MERITOR</b> Brake system	18 / 24" Corsa / Stroke 76 mm	<b>MERITOR - ROR</b> Assale serie LM-LC e TA-TC Axles parts Disco freno ELSA 2 Brake disc <b>MAN</b> <b>RENAULT</b>	41227570	41231081  N2504016066 7424990230
A	<b>718269</b>	Cilindro freno attuatore Sx / Brake actuator LH Impianto frenante <b>MERITOR</b> Brake system	18 / 24" Corsa / Stroke 76 mm	<b>MERITOR - ROR</b> Assale serie LM-LC e TA-TC Axles parts Disco freno ELSA 2 Brake disc <b>MAN</b> <b>RENAULT</b>	41227571	41231082  N2504016065 7424990231
A	<b>718272</b>	Cilindro freno attuatore Dx / Brake actuator RH Impianto frenante <b>MERITOR</b> Brake system	18 / 24" Corsa / Stroke 64 mm	<b>MERITOR - ROR</b> Assale serie LM-LC Axles parts Disco freno ELSA 195 Brake disc Assale serie TA-TC Axles parts Disco freno D DUCO Brake disc	41226807	41229062 41231594
A	<b>718286</b>	Cilindro freno attuatore Sx / Brake actuator LH Impianto frenante <b>MERITOR</b> Brake system	18 / 24" Corsa / Stroke 64 mm	<b>MERITOR - ROR</b> Assale serie LM-LC Axles parts Disco freno ELSA 195 Brake disc Assale serie TA-TC Axles parts Disco freno D DUCO Brake disc	41226806	41229063 41231595
A	<b>718288</b>	Cilindro freno attuatore Dx / Brake actuator RH Impianto frenante <b>MERITOR</b> Brake system	20 / 24" Corsa / Stroke 64 mm	<b>MERITOR - ROR</b> Assale serie LM-LC Axles parts Disco freno ELSA 195 Brake disc Assale serie TA-TC Axles parts Disco freno D DUCO Brake disc	41229067	41226811
A	<b>718270</b>	Cilindro freno attuatore Sx / Brake actuator LH Impianto frenante <b>MERITOR</b> Brake system	20 / 24" Corsa / Stroke 64 mm	<b>MERITOR - ROR</b> Assale serie LM-LC Axles parts Disco freno ELSA 195 Brake disc Assale serie TA-TC Axles parts Disco freno D DUCO Brake disc	41226810	41229066
A	<b>718311</b>	Cilindro freno attuatore Dx / Brake actuator RH Impianto frenante <b>MERITOR</b> Brake system	20 / 24" Corsa / Stroke 76 mm	<b>MERITOR - ROR</b> Assale serie LM-LC e TA-TC Axles parts Disco freno ELSA 2 Brake disc <b>RENAULT</b>	41227572	41231085  7424490232
A	<b>718310</b>	Cilindro freno attuatore Sx / Brake actuator LH Impianto frenante <b>MERITOR</b> Brake system	20 / 24" Corsa / Stroke 76 mm	<b>MERITOR - ROR</b> Assale serie LM-LC e TA-TC Axles parts Disco freno ELSA 2 Brake disc <b>RENAULT</b>	41227573	41231086  7424490233

I marchi ed i nominativi dei costruttori come pure i riferimenti originali sono esposti a solo titolo indicativo in quanto i nostri particolari non sono originali  
Manufacturer's names and part numbers in this catalogue are used for cross reference purposes only and do not imply anything about the origin or manufacturer of product.

FIG. ITEM	RIF. ERREVI ERREVI REF.	DESCRIZIONE PARTICOLARI DESCRIPTION	TIPO VEHICLE MODEL	RIF. ORIGINALE ORIGINAL REF.
-----------	-------------------------	-------------------------------------	--------------------	------------------------------

**IMPIANTI FRENO / AIR BRAKE PARTS**

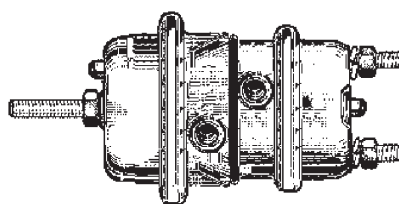

A

**1 segue CILINDRI FRENO PER FRENI A DISCO  
cont'd BRAKE CHAMBERS AND BRAKE ACTUATORS FOR BRAKE DISCS**

A	<b>718313</b>	Cilindro freno attuatore Dx / Brake actuator RH Impianto frenante <b>MERITOR</b> Brake system	22 / 24" Corsa / Stroke 76 mm	<b>MERITOR - ROR</b> Assale serie LM-LC e TA-TC Axles parts Disco freno ELSA 2 Brake disc <b>RENAULT</b>	41227574	41231087  7424490234
A	<b>718312</b>	Cilindro freno attuatore Sx / Brake actuator LH Impianto frenante <b>MERITOR</b> Brake System	22 / 24" Corsa / Stroke 76 mm	<b>MERITOR - ROR</b> Assale serie LM-LC e TA-TC Axles parts Disco freno ELSA 2 Brake disc <b>RENAULT</b>	41227575	41231088  7424490235
A	<b>718289</b>	Cilindro freno attuatore Dx / Brake actuator RH Impianto frenante <b>MERITOR</b> Brake system	24 / 24" Corsa / Stroke 64 mm	<b>MERITOR - ROR</b> Assale serie LM-LC Axles parts Disco freno ELSA 195 Brake disc Assale serie TA-TC Axles parts Disco freno D DUCO Brake disc	41229074	41229271
A	<b>718271</b>	Cilindro freno attuatore Sx / Brake actuator LH Impianto frenante <b>MERITOR</b> Brake system	24 / 24" Corsa / Stroke 64 mm	<b>MERITOR - ROR</b> Assale serie LM-LC Axles parts Disco freno ELSA 195 Brake disc Assale serie TA-TC Axles parts Disco freno D DUCO Brake disc	41229075	41229272 41231607
A	<b>718315</b>	Cilindro freno attuatore Dx / Brake actuator RH Impianto frenante <b>MERITOR</b> Brake system	24 / 24" Corsa / Stroke 76 mm	<b>MERITOR - ROR</b> Assale serie LM-LC e TA-TC Axles parts Disco freno ELSA 2 Brake disc <b>RENAULT</b>	41227867	41231089  7424490236
A	<b>718314</b>	Cilindro freno attuatore Sx / Brake actuator LH Impianto frenante <b>MERITOR</b> Brake system	24 / 24" Corsa / Stroke 76 mm	<b>MERITOR - ROR</b> Assale serie LM-LC e TA-TC Axles parts Disco freno ELSA 2 Brake disc <b>RENAULT</b>	41227868	41231090  7424490237

**2 CILINDRI FRENO PER FRENI A DISCO  
BRAKE CHAMBERS AND BRAKE ACTUATORS FOR BRAKE DISCS**

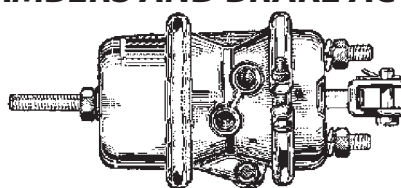

A

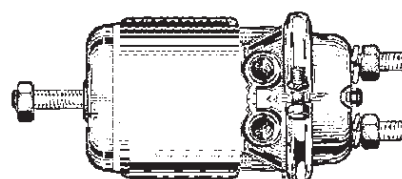

B

A	<b>718291</b>	Cilindro freno attuatore Dx / Brake actuator RH Impianto frenante <b>MERITOR</b> Brake system	16 / 24" Corsa / Stroke 76 mm	<b>MERITOR - ROR</b> Assale serie LM-LC e TA-TC Axle series Disco freno ELSA 2 Brake disc <b>MAN</b>	41227569	41231078  N2504016053
A	<b>718292</b>	Cilindro freno attuatore Sx / Brake actuator LH Impianto frenante <b>MERITOR</b> Brake system	16 / 24" Corsa / Stroke 76 mm	<b>MERITOR - ROR</b> Assale serie LM-LC e TA-TC Axle series Disco freno ELSA 2 Brake disc <b>RENAULT</b>	41227568	41231077  7424990228
A	<b>718264</b>	Cilindro freno attuatore / Brake actuator Impianto frenante <b>MERITOR</b> Brake system	20 / 24" Corsa / Stroke 64 mm	<b>MERITOR - ROR</b> Assale serie TM e LM-LC Axles parts Disco freno DX 195 Brake disc <b>MAN</b> <b>RENAULT</b>	41224965	41225765 41231055  N2504016043 7424990223

I marchi ed i nominativi dei costruttori come pure i riferimenti originali sono esposti a solo titolo indicativo in quanto i nostri particolari non sono originali  
Manufacturer's names and part numbers in this catalogue are used for cross reference purposes only and do not imply anything about the origin or manufacturer of product.

FIG. ITEM	RIF. ERREVI ERREVI REF.	DESCRIZIONE PARTICOLARI DESCRIPTION	TIPO VEHICLE MODEL	RIF. ORIGINALE ORIGINAL REF.
-----------	-------------------------	-------------------------------------	--------------------	------------------------------

## IMPIANTI FRENO / AIR BRAKE PARTS

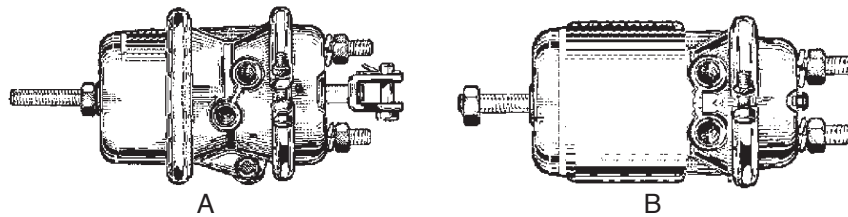

### 1 segue CILINDRI FRENO PER FRENI A DISCO cont'd BRAKE CHAMBERS AND BRAKE ACTUATORS FOR BRAKE DISCS

A	<b>718293</b>	Cilindro freno attuatore Dx / <i>Brake actuator RH</i> Impianto frenante <b>MERITOR</b> Brake system	22 / 24" Corsa / Stroke 64 mm	<b>MERITOR - ROR</b> Assale serie LM-LC e TA-TC Axle series Disco freno ELSA 2 Brake disc	41229071	41229268
A	<b>718294</b>	Cilindro freno attuatore Sx / <i>Brake actuator LH</i> Impianto frenante <b>MERITOR</b> Brake system	22 / 24" Corsa / Stroke 64 mm	<b>MERITOR - ROR</b> Assale serie LM-LC e TA-TC Axle series Disco freno ELSA 2 Brake disc	41229070	41229267
A	<b>718265</b>	Cilindro freno attuatore / <i>Brake actuator</i> Impianto frenante <b>MERITOR</b> Brake system	24 / 24" Corsa / Stroke 64 mm	<b>MERITOR - ROR</b> Assale serie TM e LM-LC Axles parts Disco freno DX 195 Brake disc  <b>DAF</b> <b>MAN</b> <b>RENAULT</b>	41225080  0905514	41225763 41231059  1489043 N2504016042 7424990221
B	<b>718254</b>	Cilindro freno attuatore / <i>Brake actuator</i> Impianto frenante <b>WABCO</b> Brake system 9254860100	12 / 24" Corsa / Stroke 57 mm	<b>MERCEDES</b>	0154205518	0204203118
B	<b>718253</b>	Cilindro freno attuatore / <i>Brake actuator</i> Impianto frenante <b>WABCO</b> Brake system 9254644500	16 / 16" Corsa / Stroke 57 mm	<b>DAF</b> <b>MERCEDES</b> <b>BPW</b>	0865611	1505447 0174208818 0203278600
B	<b>718257</b>	Cilindro freno attuatore / <i>Brake actuator</i> Impianto frenante <b>WABCO</b> Brake system 9254840000 - 9254840100	16 / 24" Corsa / Stroke 64 mm	<b>DAF</b> <b>MERCEDES</b>  <b>SCANIA</b>	1501927 0154203318 0154204118	1505446 0194205318 0194206318 1935463
B	<b>718258</b>	Cilindro freno attuatore / <i>Brake actuator</i> Impianto frenante <b>WABCO</b> Brake system 9254800000 - 9254800020	20 / 24" Corsa / Stroke 64 mm	<b>DAF</b> <b>MERCEDES</b>	1505439 0154204318 0154204718	1519442 0194205518 0194206518
B	<b>718259</b>	Cilindro freno attuatore / <i>Brake actuator</i> Impianto frenante <b>WABCO</b> Brake system 9254811500 - 9254610300	24 / 24" Corsa / Stroke 64 mm	<b>DAF</b>	1360929	1686001
B	<b>718255</b>	Cilindro freno attuatore / <i>Brake actuator</i> Impianto frenante <b>WABCO-KNORR</b> Brake system 9254810100 - 9254810120 - BS8517	24 / 24" Corsa / Stroke 64 mm	<b>DAF</b> <b>MERCEDES</b>	1505443 0154209318 0154209718	1519378 0194205718 0194206718
B	<b>718256</b>	Cilindro freno attuatore / <i>Brake actuator</i> Impianto frenante <b>WABCO</b> Brake system 9254813100	24 / 30" Corsa / Stroke 64 mm	<b>SCANIA</b>		1912988

FIG. ITEM	RIF. ERREVI ERREVI REF.	DESCRIZIONE PARTICOLARI DESCRIPTION	TIPO VEHICLE MODEL	RIF. ORIGINALE ORIGINAL REF.
-----------	-------------------------	-------------------------------------	--------------------	------------------------------

## IMPIANTI FRENO / AIR BRAKE PARTS

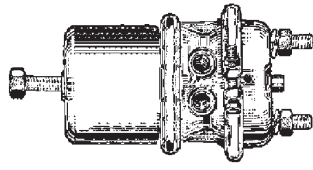
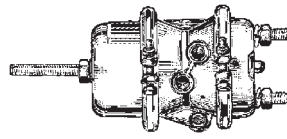
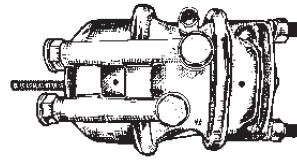
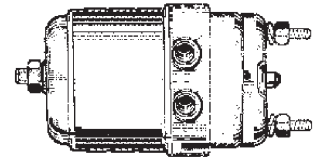

**A**

**B**

**C**

**D**

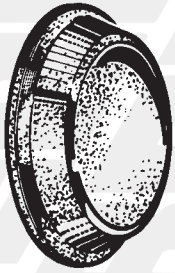
### 1

## CILINDRI FRENO PER FRENI A DISCO BRAKE CHAMBERS AND BRAKE ACTUATORS FOR BRAKE DISCS

A	<b>718250</b>	Cilindro freno attuatore / <i>Brake actuator</i> Impianto frenante <b>KNORR-HALDEX</b> <i>Brake system</i> BS9510 - II33679000	24 / 14" Corsa / Stroke 50 mm	<b>SCANIA</b>	1383090 1485834	1734994 1802664
A	<b>718251</b>	Cilindro freno attuatore / <i>Brake actuator</i> Impianto frenante <b>KNORR-HALDEX</b> <i>Brake system</i> BS9520 - II34388	24 / 24" Corsa / Stroke 60 mm	<b>SCANIA</b>		-
A	<b>718252</b>	Cilindro freno attuatore / <i>Brake actuator</i> Impianto frenante <b>WABCO-KNORR</b> <i>Brake system</i> BS8500 - K017119N00 - 9254813120	24 / 30" Corsa / Stroke 60 mm	<b>SCANIA</b>  <b>VOLVO</b>	1390369 1427474 1734995	1802658 1916992 2147779 20524534
B	<b>718194</b>	Cilindro freno attuatore / <i>Brake actuator</i> Impianto frenante <b>KNORR-HALDEX</b> <i>Brake system</i> BS7309 - 1351624004	16 / 24" Corsa / Stroke 64 mm	<b>BPW</b> <b>SAF</b>		0544440010 4454107730
B	<b>718282</b>	Cilindro freno attuatore / <i>Brake actuator</i> Impianto frenante <b>HALDEX</b> <i>Brake system</i> 346186001	18 / 24" Corsa / Stroke 64 mm	<b>BPW</b>	0544442010	0544442020
B	<b>718199</b>	Cilindro freno attuatore / <i>Brake actuator</i> Impianto frenante <b>HALDEX</b> <i>Brake system</i> 1352024003	20 / 24" Corsa / Stroke 64 mm	<b>SCHMITZ</b>		-
C	<b>718200</b>	Cilindro freni attuatore con prolunghe <i>Brake actuator c/w pipes</i> Impianto frenante <b>KNORR-HALDEX</b> <i>Brake system</i> BS7309 - 1351624004	16 / 24" Corsa / Stroke 64 mm	<b>SAF</b>		4454107764
D	<b>718284</b>	Cilindro freno Dx / <i>Brake chamber RH</i> Impianto frenante <b>KNORR-HALDEX</b> <i>Brake system</i> BT5800-BS9421-K009970-II34000	20 / 27" Corsa / Stroke 64 mm	<b>IVECO</b>	99474409	41285072
D	<b>718283</b>	Cilindro freno Sx / <i>Brake chamber LH</i> Impianto frenante <b>KNORR-HALDEX</b> <i>Brake system</i> BT5801-BS9424-K009971-II34185	20 / 27" Corsa / Stroke 64 mm	<b>IVECO</b>	99482723	41285073

# IMPIANTI FRENO / AIR BRAKE PARTS



TIPO BASSO

- 1 - 731950 9"
- 2 - 731951 12"
- 3 - 731952 16"
- 4 - 731953 20"
- 5 - 731964 22"
- 6 - 731954 24"
- 7 - 731955 30"

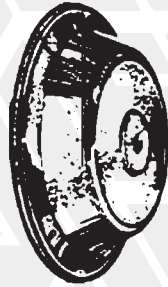

TIPO MEDIO

- 8 - 731963 12"



TIPO ALTO

- 9 - 731962 9"
- 10 - 731961 12"
- 11 - 731957 16"
- 12 - 731958 20"
- 13 - 731959 24"
- 14 - 731960 30"

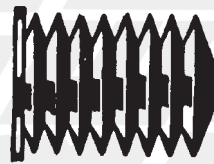

730541  
15

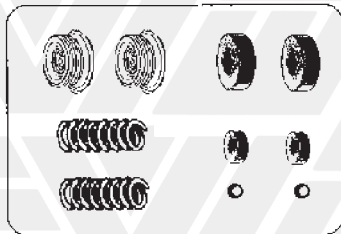

718103  
16

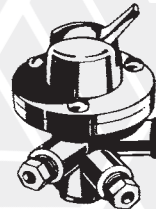

718112  
17

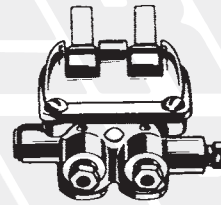

718113  
18

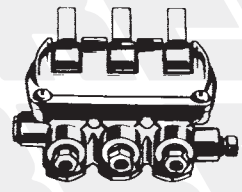

718114  
19



730518  
20

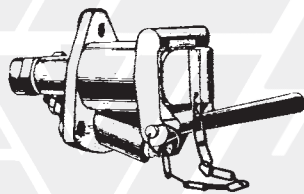

- 21 - 718101 con sfere / (with sphere)
- 22 - 718100 con puntalini / (with stem)



718110  
23



718111  
24

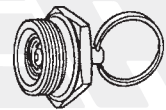

718195  
25

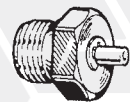

718196  
26

FIG. ITEM	RIF. ERREVI ERREVI REF.	DESCRIZIONE PARTICOLARI DESCRIPTION	TIPO VEHICLE MODEL	RIF. ORIGINALE ORIGINAL REF.
<b>IMPIANTI FRENO / AIR BRAKE PARTS</b>				
1	<b>731950</b>	Membrana per Brake Chamber Normale Bassa / <i>Diaphragm-Standard</i>	9"	8971204924
2	<b>731951</b>	Membrana per Brake Chamber Normale Bassa / <i>Diaphragm-Standard</i>	12"	-
3	<b>731952</b>	Membrana per Brake Chamber Normale Bassa / <i>Diaphragm-Standard</i>	16"	8971205104
4	<b>731953</b>	Membrana per Brake Chamber Normale Bassa / <i>Diaphragm-Standard</i>	20"	8971205204
5	<b>731964</b>	Membrana per Brake Chamber Normale Bassa / <i>Diaphragm-Standard</i>	22"	-
6	<b>731954</b>	Membrana per Brake Chamber Normale Bassa / <i>Diaphragm-Standard</i>	24"	8971205304
7	<b>731955</b>	Membrana per Brake Chamber Normale Bassa / <i>Diaphragm-Standard</i>	30"	8971205404
8	<b>731963</b>	Membrana per Brake Chamber Tipo Medio / <i>Diaphragm-Standard</i>	12"	8971205054
9	<b>731962</b>	Membrana per Brake Chamber Tipo Alto / <i>Diaphragm-Standard</i>	9"	-
10	<b>731961</b>	Membrana per Brake Chamber Tipo Alto / <i>Diaphragm-Standard</i>	12"	-
11	<b>731957</b>	Membrana per Brake Chamber Tipo Alto / <i>Diaphragm-Standard</i>	16"	8971205164
12	<b>731958</b>	Membrana per Brake Chamber Tipo Alto / <i>Diaphragm-Standard</i>	20"	8971205264
13	<b>731959</b>	Membrana per Brake Chamber Tipo Alto / <i>Diaphragm-Standard</i>	24"	8971205364
14	<b>731960</b>	Membrana per Brake Chamber Tipo Alto / <i>Diaphragm-Standard</i>	30"	8971205464
15	<b>730541</b>	Parapolvere per cilindro freni / <i>Dustcover boot</i>	ø 125 U.T. Marelli	-
16	718103	Kit revisione valvola semiaccoppiamento (con sfere) <i>Repair kit for coupling with spheres</i>		-
17	<b>718112</b>	Deviatore pneumatico a 1 via / <i>One-way switch</i>		-
18	<b>718113</b>	Deviatore pneumatico a 2 vie / <i>Two-ways switch</i>		-
19	<b>718114</b>	Deviatore pneumatico a 3 vie / <i>Three-ways switch</i>		-
20	<b>730518</b>	Guarnizione in gomma per semiaccoppiamento / <i>Air coupling seal</i>		-
21	<b>718101</b>	Valvola semiaccoppiamento fissa F22/F22 con sfere <i>Semi-coupling with sphere</i>		-
22	<b>718100</b>	Valvola semiaccoppiamento fissa F22/F22 con puntalini <i>Semi-coupling with stem</i>	Semirimorchi / <i>Semitrailers</i>	AC 425 A
23	<b>718110</b>	Valvola semiaccoppiamento mobile con puntalini <i>Semi-coupling with stem</i>	Rimorchi / <i>Trailers</i>	AC 450 A
24	<b>718111</b>	Valvola semiaccoppiamento mobile con sfere / <i>Semi-coupling with sphere</i>	Semirimorchi / <i>Semitrailers</i>	AC 465 A
25	<b>718195</b>	Valvola manuale di spurgo condensa / <i>Drain valve</i>		2486790 4672326
26	<b>718196</b>	Valvola automatica di spurgo condensa / <i>Drain valve</i>		4745905 4755126

# 1 SEMIGIUNTI ACCOPPIAMENTO / AIR COUPLINGS



730855  
1

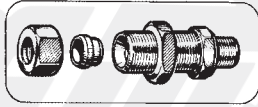

731280  
2

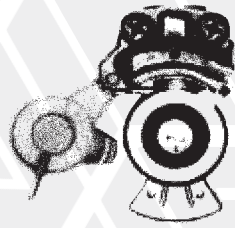

3 - 718171

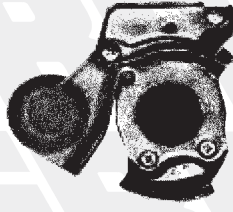

4 - 718173

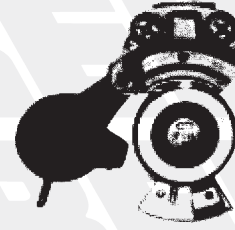

5 - 718172

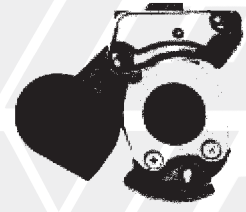

6 - 718174

# 2 TUBI DI COLLEGAMENTO PNEUMATICI / AIR COILS

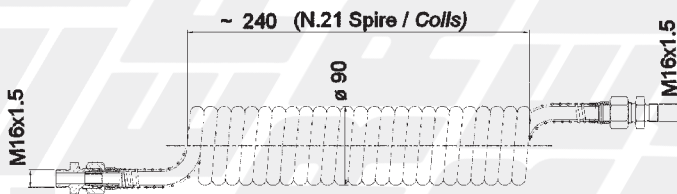

~ 240 (N.21 Spire / Colls)  
7 - 711800 ROSSO/RED  
8 - 711801 BLU/BLUE  
9 - 711802 GIALLO/YELLOW

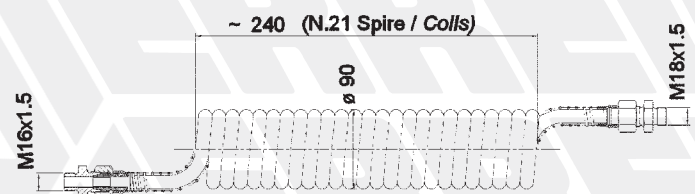

~ 240 (N.21 Spire / Colls)  
10 - 711804 NERO/BLACK

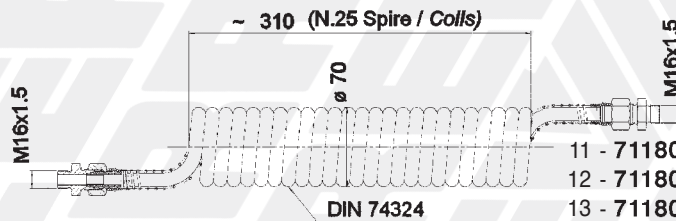

~ 310 (N.25 Spire / Colls)  
11 - 711805 ROSSO/RED  
12 - 711806 GIALLO/YELLOW  
13 - 711807 NERO/BLACK  
DIN 74324

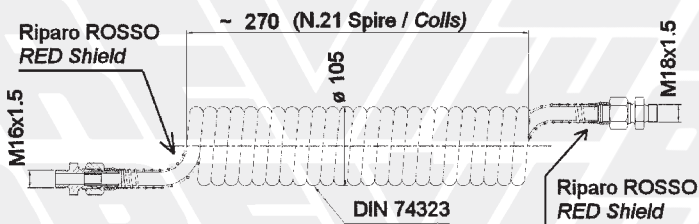

~ 270 (N.21 Spire / Colls)  
14 - 711808 NERO con RIPARI ROSSI/BLACK with RED SHIELDS  
DIN 74323

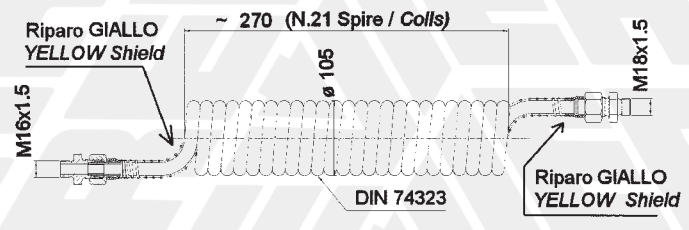

~ 270 (N.21 Spire / Colls)  
15 - 711809 NERO con RIPARI GIALLI/BLACK with YELLOW SHIELDS  
DIN 74323



FIG. ITEM	RIF. ERREVI ERREVI REF.	DESCRIZIONE PARTICOLARI DESCRIPTION	TIPO VEHICLE MODEL	RIF. ORIGINALE ORIGINAL REF.
<div style="text-align: center;"> <span style="font-size: 2em; border: 1px solid black; border-radius: 50%; padding: 5px; display: inline-block;">1</span> <b>SEMIGIUNTI ACCOPPIAMENTO</b>  <b>AIR COUPLINGS</b> </div>				
1	<b>730855</b>	Guarnizione per valvola semiaccoppiamento / <i>Palm coupling seal</i>		-
2	<b>731280</b>	Raccordo diritto attraversamento parete / <i>Palm coupling connection</i>		-
3	<b>718171</b>	Semigiunto accopp. - <b>GIALLO</b> - s/valvola/ <i>Palm coupling w/o valve (yellow dust cover)</i>		-
4	<b>718173</b>	Semigiunto accopp. - <b>GIALLO</b> - c/valvola <i>Palm coupling c/w valve (yellow dust cover)</i>		-
5	<b>718172</b>	Semigiunto accopp. - <b>ROSSO</b> - s/valvola <i>Palm coupling w/o valve (red dust cover)</i>		-
6	<b>718174</b>	Semigiunto accopp. - <b>ROSSO</b> - c/valvola <i>Palm coupling c/w valve (red dust cover)</i>		-
<div style="text-align: center;"> <span style="font-size: 2em; border: 1px solid black; border-radius: 50%; padding: 5px; display: inline-block;">2</span> <b>TUBI DI COLLEGAMENTO PNEUMATICI</b>  <b>AIR COILS</b> </div>				
7	<b>711800</b>	Tubo a spirale impianto aria - 21 Spire <i>Air coil - 21 Coils</i> Tipo <b>ROSSO / RED</b> type	Ø est. / O.D. 90 mm 170/190NT26 - 170NT35 180NT - 300PT - 170/190.35T 190i26T/.i35T - 190.30T/.38T DAF - MAN - MERCEDES SCANIA - VOLVO	4633471
8	<b>711801</b>	Tubo a spirale impianto aria - 21 Spire <i>Air coil - 21 Coils</i> Tipo <b>BLU / BLUE</b> type	Ø est. / O.D. 90 mm 170/190NT26 - 170NT35 180NT - 300PT - 170/190.35T 190i26T/i35T - 190.30T/.38T DAF - MAN - MERCEDES SCANIA - VOLVO	4633472
9	<b>711802</b>	Tubo a spirale impianto aria - 21 Spire <i>Air coil - 21 Coils</i> Tipo <b>GIALLO / YELLOW</b> type	Ø est. / O.D. 90 mm 190.30T/.38T DAF - MAN - MERCEDES SCANIA - VOLVO	4644217
10	<b>711804</b>	Tubo a spirale impianto aria - 21 Spire <i>Air coil - 21 Coils</i> Tipo <b>NERO / BLACK</b> type	Ø est. / O.D. 90 mm 175.24T - 190.30T/.38T - 260.36 190.33T/.36T/.42T/.48T - 260.48T 330.26HT/.30HT/.35HT/.36HT MERCEDES	41800543
11	<b>711805</b>	Tubo a spirale impianto aria in <b>POLIURETANO (DIN 74324)</b> - 25 Spire <i>Air coil - POLYURETHAN Type (DIN 74324) - 25 Coils</i> Tipo <b>ROSSO / RED</b> type	Ø est. / O.D. 70 mm	-
12	<b>711806</b>	Tubo a spirale impianto aria in <b>POLIURETANO (DIN 74324)</b> - 25 Spire <i>Air coil - POLYURETHAN Type (DIN 74324) - 25 Coils</i> Tipo <b>GIALLO / YELLOW</b> type	Ø est. / O.D. 70 mm	-
13	<b>711807</b>	Tubo a spirale impianto aria in <b>POLIURETANO (DIN 74324)</b> - 25 Spire <i>Air coil - POLYURETHAN Type (DIN 74324) - 25 Coils</i> Tipo <b>NERO / BLACK</b> type	Ø est. / O.D. 70 mm	-
14	<b>711808</b>	Tubo a spirale impianto aria in <b>POLIURETANO (DIN 74323)</b> - 21 Spire <i>Air coil - POLYURETHAN Type (DIN 74323) - 21 Coils</i> Con riparo <b>ROSSO / with RED</b> shield	Ø est. / O.D. 105 mm EUROTECH-EUROSTAR EUROTECH "CURSOR" EUROSTAR "CURSOR" EUROTRAKKER - STRALIS EUROTRAKKER "CURSOR"	41211250 42545899
15	<b>711809</b>	Tubo a spirale impianto aria in <b>POLIURETANO (DIN 74323)</b> - 21 Spire <i>Air coil - POLYURETHAN Type (DIN 74323) - 21 Coils</i> Con riparo <b>GIALLO / with YELLOW</b> shield	Ø est. 105 mm O.D. 105 mm EUROTECH-EUROSTAR EUROTECH "CURSOR" EUROSTAR "CURSOR" EUROTRAKKER - STRALIS EUROTRAKKER "CURSOR"	41211251 42545898

# 1 COLLEGAMENTI ELETTRICI ELECTRICAL COILS PLUGS AND SOCKETS



718415



2 - 718400  
3 - 718416  
4 - 718407  
5 - 718408  
6 - 718409  
7 - 718410

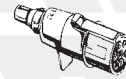

8 - 718405  
9 - 718401  
10 - 718406  
11 - 718402  
12 - 718403  
13 - 718404

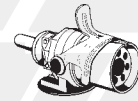

14 - 718411  
15 - 718412  
16 - 718413  
17 - 718414

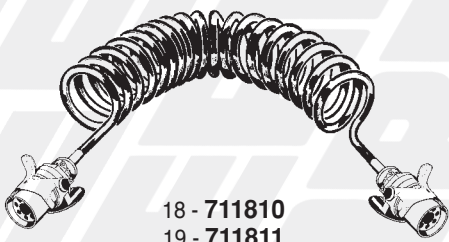

18 - 711810  
19 - 711811  
20 - 711812



21 - 711814  
22 - 711815  
23 - 711803

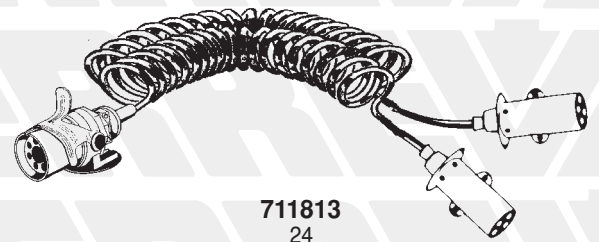

711813  
24

# 2 TUBI FLESSIBILI ARIA / AIR FLEXIBLE TUBES



25 - 711598 mm. 700  
26 - 711599 mm. 800  
27 - 711600 mm. 900

# 3 VARIE / MISCELLANEOUS

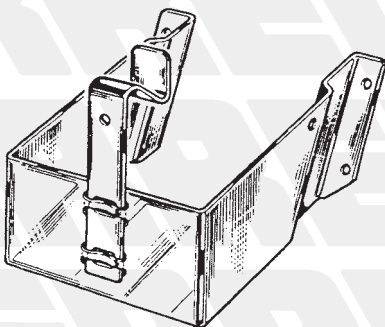

793031  
30

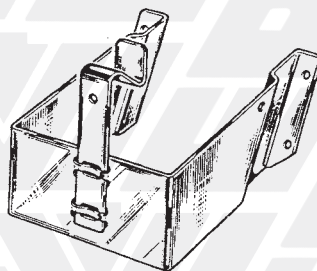

793030  
31

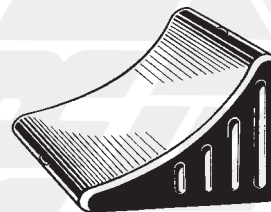

793020  
28



793021  
29



732340  
32

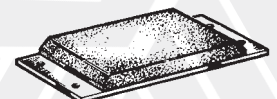

760103  
33

FIG. ITEM	RIF. ERREVI ERREVI REF.	DESCRIZIONE PARTICOLARI DESCRIPTION	TIPO VEHICLE MODEL	RIF. ORIGINALE ORIGINAL REF.
<b>1 COLLEGAMENTI ELETTRICI ELECTRICAL COILS PLUGS AND SOCKETS</b>				
1	<b>718415</b>	Adattatore a <b>15 poli</b> - 24 V - tipo <b>N / S / 15 Core adapter - 24 V - N / S types</b>	ISO 12098	-
2	<b>718400</b>	Presa a <b>7 poli</b> - 24 V - in alluminio - attacchi lamellari - <b>tipo N 7 Pin socket - 24 V aluminium - flat terminals - N type</b>	ISO 1185 DIN 72579	-
3	<b>718416</b>	Presa a <b>7 poli</b> - 24 V - in alluminio - <b>attacchi filettati - tipo N 7 Pin socket - 24 V aluminium - screw terminals - N type</b>	ISO 1185 DIN 72579	-
4	<b>718407</b>	Presa a <b>7 poli</b> - 24 V - per <b>EBS / 7 Pin EBS socket - 24 V</b>	ISO 7638	-
5	<b>718408</b>	Presa a <b>7 poli</b> - 24 V - per <b>EBS - attacchi filettati 7 Pin EBS socket - 24 V - screw terminals</b>	ISO 7638	-
6	<b>718409</b>	Presa a <b>15 poli</b> - 24 V / <b>15 Pin socket - 24 V</b>	ISO 12098	-
7	<b>718410</b>	Presa a <b>15 poli</b> - 24 V - <b>attacchi filettati 15 Pin socket - 24 V - screw terminals</b>	ISO 12098	-
8	<b>718405</b>	Spina a <b>7 poli</b> - 24 V - in alluminio - <b>attacchi filettati - tipo N 7 Pin plug - 24 V aluminium - screw terminals - N type</b>	ISO 1185 DIN 72579	-
9	<b>718401</b>	Spina a <b>7 poli</b> - 24 V - in alluminio - <b>attacchi lamellari - tipo N 7 Pin plug - 24 V aluminium - flat terminals - N type</b>	ISO 1185 DIN 72579	-
10	<b>718406</b>	Spina a <b>7 poli</b> - 24 V - in alluminio - <b>attacchi filettati - tipo S 7 Pin plug - 24 V aluminium - screw terminals - S type</b>	ISO 3731	-
11	<b>718402</b>	Spina a <b>7 poli</b> - 24 V - in termoplastica - <b>attacchi filettati - tipo N 7 Pin plug - 24 V thermoplastic - screw terminals - N type</b>	ISO 1185 DIN 72579	-
12	<b>718403</b>	Spina a <b>7 poli</b> - 24 V - in termoplastica - <b>attacchi filettati - tipo S 7 Pin plug - 24 V thermoplastic - screw terminals - S type</b>	ISO 3731	-
13	<b>718404</b>	Spina a <b>7 poli</b> - 24 V - in termoplastica <b>VERDE - attacchi filettati - tipo S 7 Pin plug - 24 V GREEN thermoplastic - screw terminals - S type</b>	ISO 3731	-
14	<b>718411</b>	Spina a <b>7 poli</b> - 24 V - per <b>EBS</b> (con anti-arrotolamento) <b>7 Pin EBS plug - 24 V - with anti-kink bush for cable</b>	ISO 7638	-
15	<b>718412</b>	Spina a <b>7 poli</b> - 24 V - per <b>EBS</b> (con anti-arrotolamento) - <b>attacchi filettati 7 Pin EBS plug - 24 V - with anti-kink bush for cable - screw terminals</b>	ISO 7638	-
16	<b>718413</b>	Spina a <b>15 poli</b> - 24 V - (con anti-arrotolamento) <b>15 Pin plug - 24 V - with anti-kink bush for cable</b>	ISO 12098	-
17	<b>718414</b>	Spina a <b>15 poli</b> - 24 V - (con anti-arrotolamento) - <b>attacchi filettati 15 Pin plug - 24 V - with anti-kink bush for cable - screw terminals</b>	ISO 12098	-
18	<b>711810</b>	Tubo a spirale impianto elettrico con spine a <b>5 Poli per ABS ABS Electrical cable with ABS (5 Pole) plugs</b>	L= 4 mt. ISO 7638	-
19	<b>711811</b>	Tubo a spirale impianto elettrico con spine a <b>7 Poli per EBS EBS Electrical cable with EBS (7 Pole) plugs</b>	L= 4 mt. ISO 7638	-
20	<b>711812</b>	Tubo a spirale impianto elettrico con spine a <b>15 Poli 15 Pole Electrical cable with 15 Pole plugs</b>	L= 3 mt. ISO 7638	-
21	<b>711814</b>	Tubo a spirale impianto elettrico con spine a <b>7 Poli - tipo N 7 Pole electrical cable with N type 24 V. plugs</b>	L= 3,5 mt. ISO 1185	-
22	<b>711815</b>	Tubo a spirale impianto elettrico con spine a <b>7 Poli - tipo S 7 Pole electrical cable with S type 24 V. plugs</b>	L= 3,5 mt. ISO 1185	-
23	<b>711803</b>	Tubo a spirale impianto elettrico - con spine a <b>7 Poli</b> in alluminio - <b>tipo N Trailer electrical cable with 7 Pole plugs - N type</b>	ISO 1185 ISO 3731	4634846
24	<b>711813</b>	Tubo a spirale impianto elettrico - con spina a <b>15 Poli</b> e <b>7 Poli - tipo N/S Trailer 15 Pole adapter cable</b>	L=3,5 mt. ISO 1185-3731 12098	-
<b>2 TUBI FLESSIBILI ARIA AIR FLEXIBLE TUBES</b>				
25	<b>711598</b>	Tubo flessibile per freni maschio/maschio / <i>Air flexible tube</i>	M22x1.5 L=700	-
26	<b>711599</b>	Tubo flessibile per freni maschio/maschio / <i>Air flexible tube</i>	M22x1.5 L=800	-
27	<b>711600</b>	Tubo flessibile per freni maschio/maschio / <i>Air flexible tube</i>	M22x1.5 L=900	-
<b>3 VARIE / MISCELLANEOUS</b>				
28	<b>793020</b>	Calzatoia ruota tipo grande / <i>Wheel chock, large type</i>		-
29	<b>793021</b>	Calzatoia ruota tipo medio / <i>Wheel chock, medium type</i>		-
30	<b>793031</b>	Supporto per calzatoia tipo grande / <i>Wheel chock holder, large type</i>		-
31	<b>793030</b>	Supporto per calzatoia tipo medio / <i>Wheel chock holder, medium type</i>		-
32	<b>732340</b>	Gancio ad occhio aperto / <i>Hook</i>		-
33	<b>760103</b>	Tampone paracolpi per cassone / <i>Rubber pad</i>		0732401

FIG. ITEM	RIF. ERREVI ERREVI REF.	DESCRIZIONE PARTICOLARI DESCRIPTION	TIPO VEHICLE MODEL	RIF. ORIGINALE ORIGINAL REF.
-----------	-------------------------	-------------------------------------	--------------------	------------------------------

**TIRANTI AGGANCIAMENTO PARAFANGO E COPRIPEDALI FRENO E FRIZIONE  
STRAP MUDGUARD TENSIONERS AND BRAKES AND CLUTCHES PEDAL PADS**

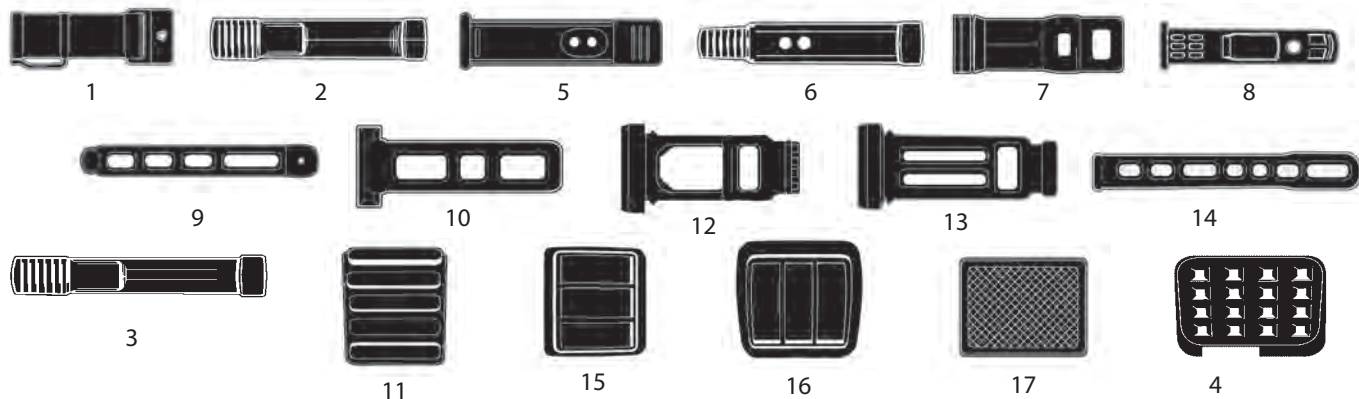

**DAF**

11	<b>730880</b>	Copripedale in gomma / Rubber pedal pad	65CF - 75CF - 85CF - 95XF CF95 - CF75 - CF85 - XF95 - XF105	82481 0082481
----	---------------	---	--	------------------

**IVECO**

1	<b>730495</b>	Tirante aggancio parafango / Strap mudguard tensioner	EUROTECH - EUROTECH "CURSOR" EUROSTAR - EUROSTAR "CURSOR" EUROTRAKKER-EUROTRAKKER "CURSOR" STRALIS	41016244
2	<b>730594</b>	Tirante aggancio parafango / Strap mudguard tensioner	EUROTECH - EUROTECH "CURSOR" EUROSTAR - EUROSTAR "CURSOR" STRALIS	42533556 42559051
3	<b>730955</b>	Tirante aggancio parafango / Strap mudguard tensioner	STRALIS TRAKKER	2997670 41213696
4	<b>730901</b>	Copripedale in gomma / Rubber pedal pad	EUROCARGO - EUROCARGO "Tector" EUROTECH - EUROTECH "Cursor" EUROSTAR - EUROSTAR "Cursor" EUROTRAKKER - EUROTRAKKER "Cursor"	8138107 503532638

**MAN**

5	<b>730492</b>	Tirante aggancio parafango / Strap mudguard tensioner	TGA	81664100226
11	<b>730888</b>	Copripedale in gomma / Rubber pedal pad	F2000 - L2000 - E2000 - M2000 F90 - M90 - TGA - TGM - TGS - TGX	81482270006

**MERCEDES**

6	<b>730493</b>	Tirante aggancio parafango / Strap mudguard tensioner		9415220067
7	<b>730494</b>	Tirante aggancio parafango / Strap mudguard tensioner		9415220167

**RENAULT**

8	<b>730496</b>	Tirante aggancio parafango / Strap mudguard tensioner		5001856184
---	---------------	---	--	------------

**SCANIA**

9	<b>730491</b>	Tirante aggancio parafango / Strap mudguard tensioner		335119
10	<b>730593</b>	Tirante aggancio parafango / Strap mudguard tensioner		1383858
11	<b>730595</b>	Copripedale in gomma / Rubber pedal pad	92 - 93 - 113 - 94 - 114 - 124 - 144	389035





**VOLVO**

12	<b>730499</b>	Tirante aggancio parafango / Strap mudguard tensioner		20498623
13	<b>730591</b>	Tirante aggancio parafango / Strap mudguard tensioner		1079981
14	<b>730592</b>	Tirante aggancio parafango / Strap mudguard tensioner		8156556
15	<b>730596</b>	Copripedale in gomma / Rubber pedal pad	F6 - F7 - F10 - F12 - F16 FL6 - FL7 - FL10 - FL12 - B12	666176 1272021
16	<b>730597</b>	Copripedale in gomma / Rubber pedal pad	FM10 - FM12 - FH12 - FH16 - B12	8144663
17	<b>730598</b>	Copripedale in gomma / Rubber pedal pad	F10 - F12 - F16 FL7 - FL10 - N7 - N10 - B12	1576051

I marchi ed i nominativi dei costruttori come pure i riferimenti originali sono esposti a solo titolo indicativo in quanto i nostri particolari non sono originali  
Manufacturer's names and part numbers in this catalogue are used for cross reference purposes only and do not imply anything about the origin or manufacturer of product.

FIG. ITEM	RIF. ERREVI ERREVI REF.	DESCRIZIONE PARTICOLARI DESCRIPTION	TIPO VEHICLE MODEL	RIF. ORIGINALE ORIGINAL REF.
<b>FASCETTE DI FISSAGGIO / CLAMPS</b>				
<b>DAF</b>				
5	<b>733513</b>	Fascetta tubo impianto scarico / <i>Clamp, exhaust</i>	ø 126/132 L= 50 85CF - 95XF	1296068
<b>MAN</b>				
1	<b>733504</b>	Fascetta tubo impianto scarico / <i>Clamp, exhaust</i>	ø 112/122 L= 25 TGA - TGS - TGX	06674190006
1	<b>733511</b>	Fascetta tubo impianto scarico / <i>Clamp, exhaust</i>	ø 132/146 L= 25	06674104153
<b>RENAULT</b>				
1	<b>733510</b>	Fascetta tubo impianto scarico / <i>Clamp, exhaust</i>	ø 63/71 L= 20 KERAX - MAGNUM DXi	7420592787
1	<b>733511</b>	Fascetta tubo impianto scarico / <i>Clamp, exhaust</i>	ø 132/146 L= 25 KERAX - MAGNUM DXi - PREMIUM 2	7401629499
1	<b>733512</b>	Fascetta tubo impianto scarico / <i>Clamp, exhaust</i>	ø 91/96 L= 20	7420592783 7420787709
5	<b>733513</b>	Fascetta tubo impianto scarico / <i>Clamp, exhaust</i>	ø 126/132 L= 50 KERAX - MAGNUM DXi - PREMIUM 2	7420455908
<b>SCANIA</b>				
1	<b>733500</b>	Fascetta tubo impianto scarico / <i>Clamp, exhaust</i>	ø 126/136 L= 25 Serie P - G - R - T Series 94 - 114 - 124 - 144 - 164	1431579 1863832
1	<b>733501</b>	Fascetta tubo impianto scarico / <i>Clamp, exhaust</i>	ø 62/72 L= 20 Serie P - G - R - T Series 94 - 114 - 124 - 144 - 164	1371085 1392944 1439822
1	<b>733502</b>	Fascetta tubo impianto scarico / <i>Clamp, exhaust</i>	ø 90/100 L= 20 Serie P - G - R - T Series 94 - 114 - 124 - 144 - 164	1352704 1391051 1439823 1445398
1	<b>733503</b>	Fascetta tubo impianto scarico / <i>Clamp, exhaust</i>	ø 82/90 L= 20 Serie F - K - N Series 94 - 114 - 124 - 144 - 164	1340727 1439825
1	<b>733504</b>	Fascetta tubo impianto scarico / <i>Clamp, exhaust</i>	ø 112/122 L= 25 Serie P - G - R - T Series 94 - 114 - 124 - 144 - 164	1355963 1371089 1387136 1422474
1	<b>733505</b>	Fascetta tubo impianto scarico / <i>Clamp, exhaust</i>	ø 112/122 L= 25 Serie F - K - N Series 94 - 114 - 124 - 144 - 164	1352668 1371086 1392945 1431701 1433190
2	<b>733506</b>	Fascetta serbatoio aria / <i>Clamp, air tank</i>	Serie P - R - T Series 94 - 114 - 124 - 144 - 164	1355690 1724861
3	<b>733507</b>	Fascetta serbatoio aria / <i>Clamp, air tank</i>	Serie P - G - R - T Series 94 - 114 - 124 - 144 - 164	1355687 1391742
4	<b>733508</b>	Fascetta serbatoio aria / <i>Clamp, air tank</i>	Serie P - G - R - T Series 94 - 114 - 124 - 144 - 164	1391956 1724862
2	<b>733509</b>	Fascetta serbatoio aria / <i>Clamp, air tank</i>	Serie P - G - R - T Series 94 - 114 - 124 - 144 - 164	1383657 1427797 1724860
<b>VOLVO</b>				
1	<b>733510</b>	Fascetta tubo impianto scarico / <i>Clamp, exhaust</i>	ø 63/71 L= 20 F10 - F12 - F16 - FH - FH12 - FH16 FL6 - FL7 - FL10 - FL12 - FM - FM7 - FM9 FM10 - FM12 - B6 - B7 - B9 - B10 - B12	1542778 20592787
1	<b>733511</b>	Fascetta tubo impianto scarico / <i>Clamp, exhaust</i>	ø 132/146 L= 25 FM - FH - FH16	21029030
1	<b>733512</b>	Fascetta tubo impianto scarico / <i>Clamp, exhaust</i>	ø 91/96 L= 20 FH - FH12 - FH16 FM - FM7 - FM9 - FM10 - FM12 FL12 - B9 - B12	1676424 20592783 20787709
5	<b>733513</b>	Fascetta tubo impianto scarico / <i>Clamp, exhaust</i>	ø 126/132 L= 50 FH12 - FH16 - FH - FL12 FM10 - FM12 - FM7 - FM9 - FM	8156156 20383088 20455908
6	<b>733514</b>	Fascetta tubo impianto scarico / <i>Clamp, exhaust</i>	ø 140/164 L= 34 FH12 - FH16 - FH FM12 - FM9 - FM	1629499

FIG. ITEM	RIF. ERREVI ERREVI REF.	DESCRIZIONE PARTICOLARI DESCRIPTION	TIPO VEHICLE MODEL	RIF. ORIGINALE ORIGINAL REF.
<b>RIVETTI PER CEPPI FRENO BRAKE LINING RIVETS</b>				
1	731367	Rivetti in alluminio semiforati / Aluminium - Semi-tubular	∅ 6x15 T ∅ 12	-
2	731366	Rivetti in alluminio semiforati / Aluminium - Semi-tubular	∅ 6x18 T ∅ 12	-
3	731365	Rivetti in alluminio semiforati / Aluminium - Semi-tubular	∅ 6x20 T ∅ 12	-
4	731360	Rivetti in alluminio semiforati / Aluminium - Semi-tubular	∅ 8x18 T ∅ 16	-
5	731354	Rivetti in alluminio semiforati / Aluminium - Semi-tubular	∅ 8x20 T ∅ 13	-
6	731363	Rivetti in alluminio semiforati / Aluminium - Semi-tubular	∅ 8x20 T ∅ 16	-
7	731355	Rivetti in alluminio semiforati / Aluminium - Semi-tubular	∅ 8x23 T ∅ 13	-
8	731361	Rivetti in alluminio semiforati / Aluminium - Semi-tubular	∅ 8x23 T ∅ 16	-
9	731481	Rivetti in ottone semiforati / Brass - Semi-tubular	∅ 5x15 T ∅ 12	-
10	731482	Rivetti in ottone semiforati / Brass - Semi-tubular	∅ 5x16 T ∅ 12	-
11	731370	Rivetti in ottone semiforati / Brass - Semi-tubular	∅ 6.3x14 T ∅ 12	-
12	731451	Rivetti in ottone semiforati / Brass - Semi-tubular	∅ 6.3x16 T ∅ 12	-
13	731368	Rivetti in ottone semiforati / Brass - Semi-tubular	∅ 6.3x17.4 T ∅ 12	-
14	731450	Rivetti in ottone semiforati / Brass - Semi-tubular	∅ 6.3x18 T ∅ 12	-
15	731369	Rivetti in ottone semiforati / Brass - Semi-tubular	∅ 6.3x20 T ∅ 12	-
16	731483	Rivetti in ottone semiforati / Brass - Semi-tubular	∅ 6.6x18 T ∅ 12	-
17	731452	Rivetti in ottone tubolare / Brass - Fully tubular	∅ 8x20 T ∅ 16	-
18	731493	Rivetti in ottone tubolare / Brass - Fully tubular	∅ 8x16 T ∅ 15.5	-
19	731494	Rivetti in ottone tubolare / Brass - Fully tubular	∅ 8x18 T ∅ 15.5	-
20	731495	Rivetti in ottone tubolare / Brass - Fully tubular	∅ 8x20 T ∅ 15.5	-
21	731454	Rivetti in ottone tubolare / Brass - Fully tubular	∅ 8x23 T ∅ 16	-
22	731456	Rivetti in rame tubolare / Copper - Fully tubular	∅ 10x18 T ∅ 18	-
23	731458	Rivetti in rame semiforati / Copper - Semi-tubular	∅ 6.3x19 T ∅ 12	-
24	731471	Rivetti in ferro tubolare / Iron - Fully tubular	∅ 8x22 T ∅ 13.5	-
25	731472	Rivetti in ferro tubolare / Iron - Fully tubular	∅ 6.3x17.5 T ∅ 12	-
26	731384	Rivetti in ferro tubolare / Iron - Fully tubular	∅ 6.3x20 T ∅ 12	-
27	731473	Rivetti in ferro tubolare / Iron - Fully tubular	∅ 6.3x14.5 T ∅ 12 (doppio foro)	-
28	731474	Rivetti in ferro tubolare / Iron - Fully tubular	∅ 8x16 T ∅ 15.5	-
29	731475	Rivetti in ferro tubolare / Iron - Fully tubular	∅ 8x18 T ∅ 15.5	-
30	731476	Rivetti in ferro tubolare / Iron - Fully tubular	∅ 8x20 T ∅ 15.5	-
31	731477	Rivetti in ferro tubolare / Iron - Fully tubular	∅ 8x22 T ∅ 15.5	-
32	731500	Rivetti in ferro semiforati / Iron - Semi-tubular	∅ 6.6x18 T ∅ 12	-

FIG. ITEM	RIF. ERREVI ERREVI REF.	DESCRIZIONE PARTICOLARI DESCRIPTION	TIPO VEHICLE MODEL	RIF. ORIGINALE ORIGINAL REF.
<div style="text-align: center;"> <h1>1 INGRASSATORI / GREASE FITTINGS</h1>     </div>				
1	<b>731371</b>	Ingrassatore diritto a punta / <i>Straight type</i>	M10x1	13407211
2	<b>731373</b>	Ingrassatore a 45° a punta / <i>45° Angle type</i>	M10x1	13407811
3	<b>731374</b>	Ingrassatore a 90° a punta / <i>90° Angle type</i>	M10x1	13408411
4	<b>731376</b>	Ingrassatore diritto a punta / <i>Straight type</i>	M8x1	-
5	<b>731377</b>	Ingrassatore a 45° a punta / <i>45° Angle type</i>	M8x1	-
6	<b>731381</b>	Ingrassatore diritto a punta / <i>Straight type</i>	M6x1	-
<div style="text-align: center;"> <h1>2 STAFFE VARIE / U BOLTS</h1> </div>				
7	<b>723717</b>	Staffa balestra Tonda con dadi / <i>U Bolt c/w nuts</i>	∅ 20x90x220	-
8	<b>723723</b>	Staffa balestra Tonda con dadi / <i>U Bolt c/w nuts</i>	∅ 20x90x280	-
9	<b>723734</b>	Staffa balestra Quadra con dadi / <i>U Bolt c/w nuts</i>	∅ 20x100x120	-
10	<b>723736</b>	Staffa balestra Quadra con dadi / <i>U Bolt c/w nuts</i>	∅ 20x100x130	-
11	<b>723738</b>	Staffa balestra Quadra con dadi / <i>U Bolt c/w nuts</i>	∅ 20x100x150	-
12	<b>723746</b>	Staffa balestra Quadra con dadi / <i>U Bolt c/w nuts</i>	∅ 20x100x230	-
13	<b>723748</b>	Staffa balestra Quadra con dadi / <i>U Bolt c/w nuts</i>	∅ 20x100x250	-
14	<b>723752</b>	Staffa balestra Quadra con dadi / <i>U Bolt c/w nuts</i>	∅ 20x100x280	-
15	<b>723756</b>	Staffa balestra Quadra con dadi / <i>U Bolt c/w nuts</i>	∅ 20x100x300	-