

RICAMBI VARI PER MOTRICI, RIMORCHI E SEMIRIMORCHI TRUCKS, TRAILERS AND SEMITRAILERS MISCELLANEOUS PARTS

RICAMBI PER / SPARE PARTS FOR

RICAMBI PER RALLE SEMIRIMORCHI FIFTH WHEEL ACCESSORIES	pag. 254 - 255
PERNI ANCORAGGIO SEMIRIMORCHI SEMITRAILER KING PINS	pag. 254 - 255
CILINDRI FRENO / BRAKE CHAMBERS	pag. 256 - 263
IMPIANTI FRENO / AIR BRAKE PARTS	pag. 264 - 265
SEMIGIUNTI ACCOPPIAMENTO / AIR COUPLINGS	pag. 266 - 267
TUBI DI COLLEGAMENTO PNEUMATICI / AIR BRAKE COILS	pag. 266 - 267
COLLEGAMENTI ELETTRICI ELECTRICAL COILS, PLUGS AND SOCKETS	pag. 268 - 269
TUBI FLESSIBILI ARIA / AIR FLEXIBLE TUBES	pag. 268 - 268
CALZATOIE / WHEEL CHOCKS	pag. 268 - 268
RIVETTI PER CEPPI FRENO / BRAKE LINING RIVETS	pag. 270
INGRASSATORI / GREASE FITTINGS	pag. 271
STAFFE VARIE / U BOLTS	pag. 272

1 RICAMBI PER RALLE SEMIRIMORCHI / FIFTH WHEEL ACCESSORIES

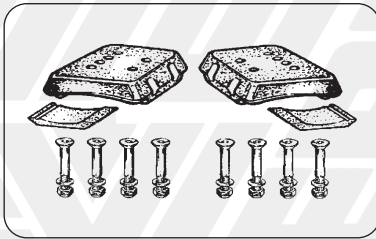
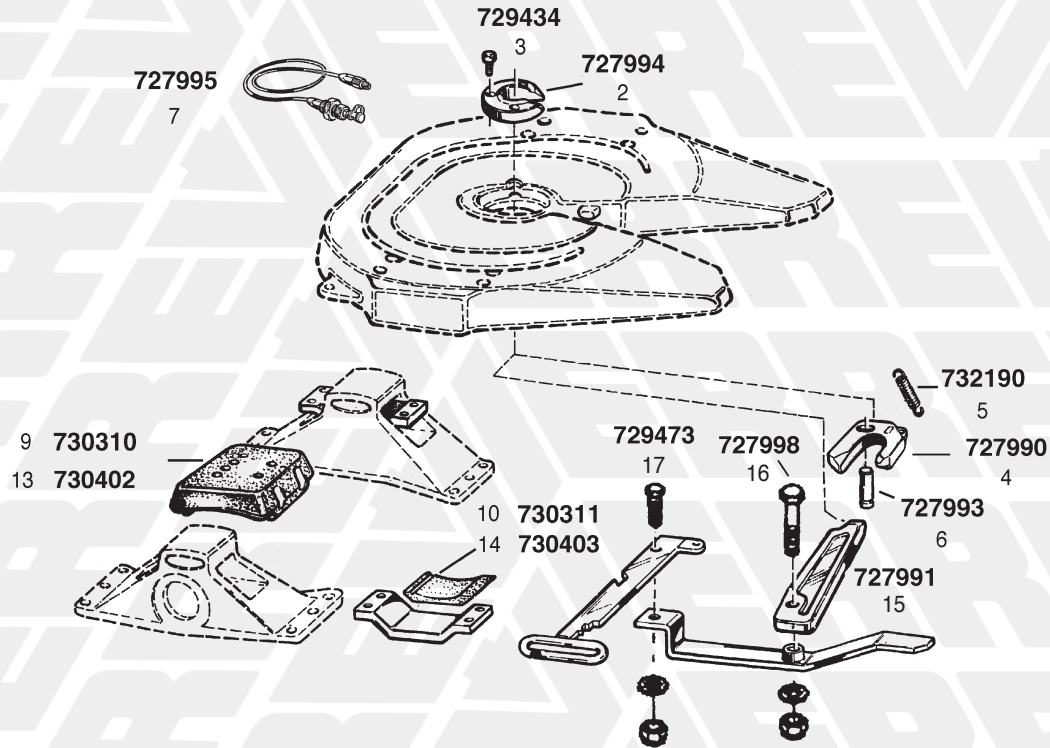

711944
8

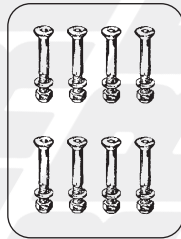

711978
11

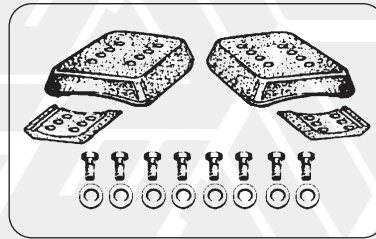

711974
12

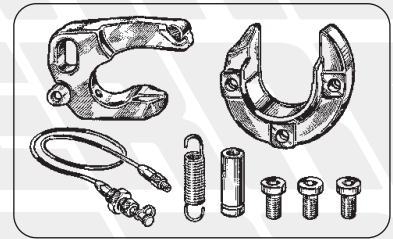

711945
1

2 PERNI ANCORAGGIO SEMIRIMORCHI / SEMITRAILER KING PIN



725821
18

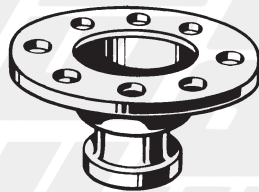

720820
19

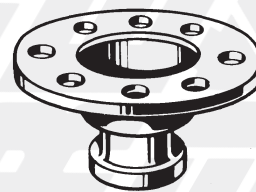

20 - 720819 con fori svasati



729475
23

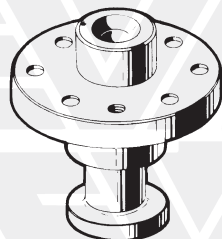

720806
21

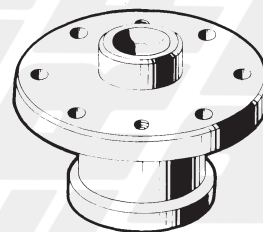

720818
22

FIG. ITEM	RIF. ERREVI ERREVI REF.	DESCRIZIONE PARTICOLARI DESCRIPTION	TIPO VEHICLE MODEL	RIF. ORIGINALE ORIGINAL REF.
1 RICAMBI PER RALLE SEMIRIMORCHI / FIFTH WHEEL ACCESSORIES INTERCAMBIABILE CON TIPO JOST / INTERCHANGEABLE WITH JOST TYPE JSK 36 DA/DV - JSK 37 C/CW/E/EW/EA/EAW/ER/ERW - JSK 38				
1	711945	Kit riparazione ralla composto da: Fifth wheel jaw reair kit complete with:	JSK 37 C/E/EA/ER	SK 3221-50 Z
2	727994	(1) Anello di usura / <i>Wear ring</i>	JSK 36 DA/DV - JSK 37 C/E/EA/ER	SK 2105-19
3	729434	(3) Bullone fiss. anello di usura / <i>Wear ring bolt</i>	M14x2 L=24 JSK 36 DA/DV - JSK 37 C/E/EA/ER	SK 2121-07
4	727990	(1) Ganascia di bloccaggio / <i>Jaw</i>	JSK 37 C/CW/E/EW/EA/EAW/ER/ERW	SK 1489 Z
5	732190	(1) Molla per ganascia / <i>Jaw spring</i>	JSK 36 DA/DV JSK 37 C/CW/E/EW/EA/EAW/ER/ERW	SK 847
6	727993	(1) Perno per ganascia / <i>Pivot pin</i>	ø 20x65 JSK 36 DA/DV JSK 37 C/CW/E/EW/EA/EAW/ER/ERW	SK 2106-67
7	727995	(1) Kit ingrassatore / <i>Grease fitting kit</i>	JSK 37 C/CW/E/EW/EA/EAW/ER/ERW	SK 3108-02
8	711944	Kit tamponi sostegno composto da: Rubber pad kit complete with:	JSK 37 C/CW	SK 2121-69
9	730310	(2) Tampone in gomma sup. / <i>Rubber pad, top</i>	JSK 37 C/CW	SK 1259
10	730311	(2) Tampone in gomma inf. / <i>Rubber pad, bottom</i>	JSK 37 C/CW	SK 2105-25
11	711978	Kit bulloni testa svasata (8 pz.) / <i>Countersunk bolts kit (8 pcs.)</i>	M16x100 JSK 37 C/CW	SK 2121-15
12	711974	Kit tamponi sostegno composto da: Rubber pad kit complete with:	JSK 38	SK 2421-78
13	730402	(2) Tampone in gomma sup. / <i>Rubber pad, top</i>	JSK 38	SK 2006
14	730403	(2) Tampone in gomma inf. / <i>Rubber pad, bottom</i>	JSK 38	SK 2007
		(8) Bullone / <i>Bolt</i>	JSK 38	-
		(8) Rondella / <i>Washer</i>	JSK 38	-
15	727991	Chiavistello di bloccaggio / <i>Latch</i>	JSK 37 C/CW/E/EW/EA/EAW/ER/ERW	SK 3205-06
16	727998	Perno per chiavistello completo / <i>Latch pin complete</i>	ø 20x95 JSK 37 C/CW/E/EW/EA/EAW/ER/ERW	SK 3221-01
17	729473	Vite con rondella e dado / <i>Bolt with washer and nut</i>	JSK 36 DA/DV JSK 37 C/CW/E/EW/EA/EAW/ER/ERW	SK 1513
2 PERNI ANCORAGGIO SEMIRIMORCHI SEMITRAILER KING PIN				
18	725821	Boccola per trasformazione perni ancoraggio da 2" a 3"½ <i>Bolt-in king pin adaptor (converts 2" to 3"½)</i>		-
19	720820	Perno ancoraggio 2" / <i>Bolt-in king pin 2"</i>	8 fori / holes flangia / flange ø 200	VIBERTI - ADIGE JOST 112349207 KZ 1012-01
20	720819	Perno ancoraggio 2" / <i>Bolt-in king pin 2"</i>	8 fori svasati 8 countersink holes flangia / flange ø 200	JOST KZ 0912-01
21	720806	Perno ancoraggio 2" / <i>Bolt-in king pin 2"</i>	6 fori / holes flangia / flange ø 160	BERSAGLIERE U. PIACENZA FRANCHIN - ZORZI MINERVA 100066
22	720818	Perno ancoraggio 3"½ / <i>Bolt-in king pin 3"½</i>	6 fori / holes flangia / flange ø 170	BERSAGLIERE U. PIACENZA FRANCHIN - ZORZI MINERVA -
23	729475	Vite fissaggio perni ancoraggio / <i>King pin bolt</i>	M14x2 L=35	JOST KZE 1012-03

FIG. ITEM	RIF. ERREVI ERREVI REF.	DESCRIZIONE PARTICOLARI DESCRIPTION	TIPO VEHICLE MODEL	RIF. ORIGINALE ORIGINAL REF.
-----------	-------------------------	-------------------------------------	--------------------	------------------------------

IMPIANTI FRENO / AIR BRAKE PARTS

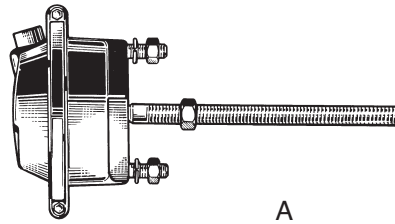

1 CILINDRI FRENO PER FRENI A TAMBURO BRAKE CHAMBERS AND SPRING BRAKE ACTUATORS FOR BRAKE DRUMS

A	718290	Cilindro freno / <i>Brake chamber</i> Impianto frenante WABCO-KNORR Brake system 4231039000 - BZ3268	12" Corsa / Stroke 75 mm	DAF MAN RENAULT SCANIA BPW	BBU5929 81511016207 81511016211	1505025 81511016216 81511019203 5430053317 1932620 0544412010
A	718099	Cilindro freno / <i>Brake chamber</i> Impianto frenante WABCO-KNORR Brake system 4231049000 - BZ3374	16" Corsa / Stroke 75 mm	DAF MAN MERCEDES RENAULT SCANIA BPW	BBU5930 1010153	0745398 0834481 81511016249 0014200924 5021170047 1912301 0544413010
A	718098	Cilindro freno / <i>Brake chamber</i> Impianto frenante WABCO-KNORR Brake system 4231059000 - BX3419	20" Corsa / Stroke 75 mm	DAF IVECO MERCEDES RENAULT SCANIA BPW	BBU5931 4676322 6984203721 0203362000	0834482 4760117 6994200724 5021170049 1738479 0544414010
A	718094	Cilindro freno / <i>Brake chamber</i> Impianto frenante WABCO-KNORR Brake system 4231069000 - BX3538	24" Corsa / Stroke 75 mm	DAF MERCEDES RENAULT SCANIA VOLVO BPW	BBU5932 0014203524 1010154 0544415010	0834483 0064201718 5021170051 1738480 6212188 0544415110
A	718097	Cilindro freno / <i>Brake chamber</i> Impianto frenante WABCO-KNORR Brake system 4231079000 - BX3607	30" Corsa / Stroke 75 mm	DAF RENAULT SCANIA BPW	BBU5933 1010155 0544416010	0705707 0834484 5021170052 1738481 0544416110

I marchi ed i nominativi dei costruttori come pure i riferimenti originali sono esposti a solo titolo indicativo in quanto i nostri particolari non sono originali
 Manufacturer's names and part numbers in this catalogue are used for cross reference purposes only and do not imply anything about the origin or manufacturer of product.

FIG. ITEM	RIF. ERREVI ERREVI REF.	DESCRIZIONE PARTICOLARI DESCRIPTION	TIPO VEHICLE MODEL	RIF. ORIGINALE ORIGINAL REF.
-----------	-------------------------	-------------------------------------	--------------------	------------------------------

IMPIANTI FRENO / AIR BRAKE PARTS

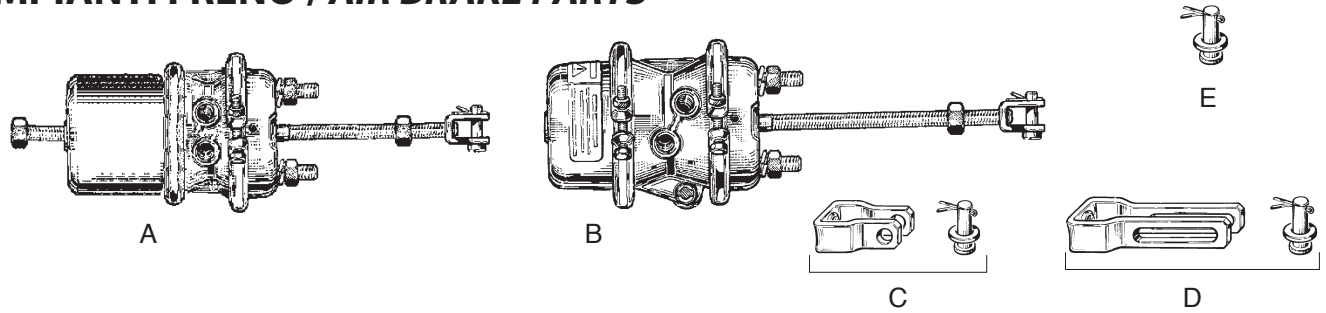

**1 CILINDRI FRENO PER FRENI A TAMBURO
BRAKE CHAMBERS AND SPRING BRAKE ACTUATORS FOR BRAKE DRUMS**

A	718299	Cilindro freno attuatore / <i>Brake actuator</i> Impianto frenante KNORR Brake system BX7401	20 / 24" Corsa / Stroke 57 mm	DAF IVECO RENAULT SCANIA	0878092 1384266	0905270 0905272 500037066 5021133573 2121851
A	718260	Cilindro freno attuatore / <i>Brake actuator</i> Impianto frenante WABCO Brake system 9254901020	20 / 24" Corsa / Stroke 65 mm	DAF	1518313	1818155
A	718261	Cilindro freno attuatore / <i>Brake actuator</i> Impianto frenante WABCO Brake system 9254911430	24 / 30" Corsa / Stroke 64 mm	DAF	1519444	1519187
A	718262	Cilindro freno attuatore / <i>Brake actuator</i> Impianto frenante WABCO Brake system 9254990010	27 / 30" Corsa / Stroke 65 mm	RENAULT		5021170342
A	718263	Cilindro freno attuatore / <i>Brake actuator</i> Impianto frenante WABCO Brake system 9254921020 - 8901103530	30 / 30" Corsa / Stroke 64 mm	DAF IVECO MAN MERCEDES RENAULT SCANIA	1270262 1305170 81504106675 81504106676 0134206618	1518149 1519164 5000869541 81504106679 81504106680 0164200418 0194208518 5010067834 1935475
B	718184	Cilindro freno attuatore / <i>Brake actuator</i> Impianto frenante KNORR Brake system BX7516	24 / 24" Corsa / Stroke 64 mm	DAF		-
B	718189	Cilindro freno attuatore / <i>Brake actuator</i> Impianto frenante WABCO-KNORR Brake system 9253712000 - BX7515	24 / 30" Corsa / Stroke 75 mm	DAF RENAULT BPW SCHMITZ	0203273900 0544420010	1325352 5021170326 0544420040 0544420100 050408
B	718190	Cilindro freno attuatore / <i>Brake actuator</i> Impianto frenante WABCO-KNORR Brake system 9253722000 - 9253723000 - BX7611	30 / 30" Corsa / Stroke 64 mm	DAF RENAULT SCANIA BPW SAF	0544421040	1325351 5021170327 1738483 0544421110 4454105800
C	718180	Forcellino corto con foro completo di perno <i>Yoke with pivot</i>	ø 14			-
D	718181	Forcellino lungo con asola completo di perno <i>Oblong yoke with pivot</i>	ø 14			-
E	718166	Pernetto per forcellino / <i>Pivot</i>	ø 14			-

I marchi ed i nominativi dei costruttori come pure i riferimenti originali sono esposti a solo titolo indicativo in quanto i nostri particolari non sono originali
 Manufacturer's names and part numbers in this catalogue are used for cross reference purposes only and do not imply anything about the origin or manufacturer of product.

FIG. ITEM	RIF. ERREVI ERREVI REF.	DESCRIZIONE PARTICOLARI DESCRIPTION	TIPO VEHICLE MODEL	RIF. ORIGINALE ORIGINAL REF.
-----------	-------------------------	-------------------------------------	--------------------	------------------------------

IMPIANTI FRENO / AIR BRAKE PARTS

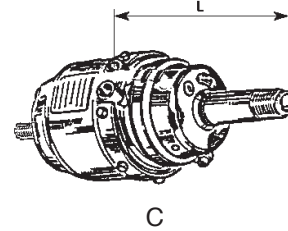
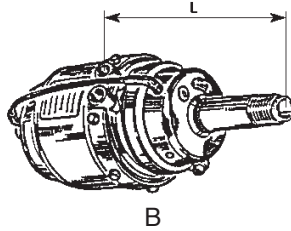
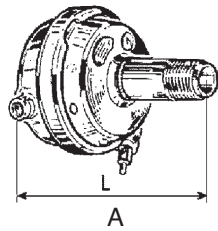
1

CILINDRI FRENO PER FRENI A TAMBURO

BRAKE CHAMBERS AND SPRING BRAKE ACTUATORS FOR BRAKE DRUMS

A	718186	Cilindro freno / Brake chamber Impianto frenante WABCO-KNORR Brake system 4231430010 - EF120P	12" L= 138 Corsa / Stroke 50 mm	IVECO MAN RENAULT	4464432 4713105	42126941 92900312 N1011015187 5021170053
A	718188	Cilindro freno / Brake chamber Impianto frenante WABCO-KNORR Brake system 4231430070 - EF120L	12" L= 157 Corsa / Stroke 50 mm	IVECO	42066420	42066442 42070658
B	718187	Cilindro freno / Brake chamber Impianto frenante WABCO-KNORR Brake system 4253270670 - BFM121C	12" L=157 Corsa / Stroke 50 mm	IVECO	42070539 42071449	98446238 98446264
B	718088	Cilindro freno / Brake chamber Impianto frenante WABCO-KNORR Brake system 4253270540 - 4253270640 - BY7206 - BFM121BK	12" L=187 Corsa / Stroke 50 mm	DAF IVECO RENAULT	42071450 42072532	1518655 42072536 98446217 5010118947
A	718297	Cilindro freno / Brake chamber Impianto frenante KNORR Brake system EF161DY	16" L = 168 Corsa / Stroke 55 mm	ASTRA IVECO	185905	98185905 98185905
A	718298	Cilindro freno / Brake chamber Impianto frenante KNORR Brake system EF161CY	16" L = 330 Corsa / Stroke 55 mm	ASTRA IVECO		98194985 98194985
A	718296	Cilindro freno / Brake chamber Impianto frenante KNORR Brake system EF241MY	24" L = 275 Corsa / Stroke 60 mm	ASTRA IVECO	167957	98167957 98167957
C	718273	Cilindro freno / Brake chamber Impianto frenante WABCO-KNORR Brake system 4253460020 - 4254460020 - BY9225 - BY9236 - BFM122BK	12 / 20" L=187 Corsa / Stroke 53 mm	DAF IVECO	42052855	1505955 98446265
C	718295	Cilindro freno / Brake chamber Impianto frenante WABCO-KNORR Brake system BY9205	12 / 20" L = 187 Corsa / Stroke 53 mm	IVECO	4835041	98403027 99446699
C	718274	Cilindro freno / Brake chamber Impianto frenante KNORR Brake system BY9250	14 / 20" L=180 Corsa / Stroke 53 mm	IVECO	41285147	98412993 99446702
C	718275	Cilindro freno / Brake chamber Impianto frenante KNORR Brake system BY9260	14 / 24" L=190 Corsa / Stroke 53 mm	IVECO		41013260
C	718279	Cilindro freno / Brake chamber Impianto frenante KNORR Brake system BY9276	14 / 24" L=190 Corsa / Stroke 64 mm	IVECO		41211359
C	718276	Cilindro freno / Brake chamber Impianto frenante KNORR Brake system BY9278 - BY9303	16 / 24" L=190 Corsa / Stroke 53 mm	ASTRA IVECO	41001830 41211374	- 41285149 41285150
C	718280	Cilindro freno / Brake chamber Impianto frenante KNORR Brake system BY9328	16 / 24" L=190 Corsa / Stroke 64 mm	ASTRA IVECO	41211078	41285153 41285153
C	718277	Cilindro freno / Brake chamber Impianto frenante KNORR Brake system BY9351	18 / 24" L=190 Corsa / Stroke 53 mm	IVECO	8169240	8189492
C	718316	Cilindro freno / Brake chamber Impianto frenante KNORR Brake system BY9401	20 / 24" L=190 Corsa / Stroke 53 mm	DAF IVECO	8137483	1520873 8169241
C	718317	Cilindro freno / Brake chamber Impianto frenante KNORR Brake system BY9451	22 / 24" L=190 Corsa / Stroke 53 mm	IVECO		41006333
C	718278	Cilindro freno / Brake chamber Impianto frenante KNORR Brake system BY9500	24 / 24" L=190 Corsa / Stroke 53 mm	ASTRA IVECO	8137768 8189491	115107 8189495 41015818

I marchi ed i nominativi dei costruttori come pure i riferimenti originali sono esposti a solo titolo indicativo in quanto i nostri particolari non sono originali
 Manufacturer's names and part numbers in this catalogue are used for cross reference purposes only and do not imply anything about the origin or manufacturer of product.

FIG. ITEM	RIF. ERREVI ERREVI REF.	DESCRIZIONE PARTICOLARI DESCRIPTION	TIPO VEHICLE MODEL	RIF. ORIGINALE ORIGINAL REF.
-----------	-------------------------	-------------------------------------	--------------------	------------------------------

IMPIANTI FRENO / AIR BRAKE PARTS

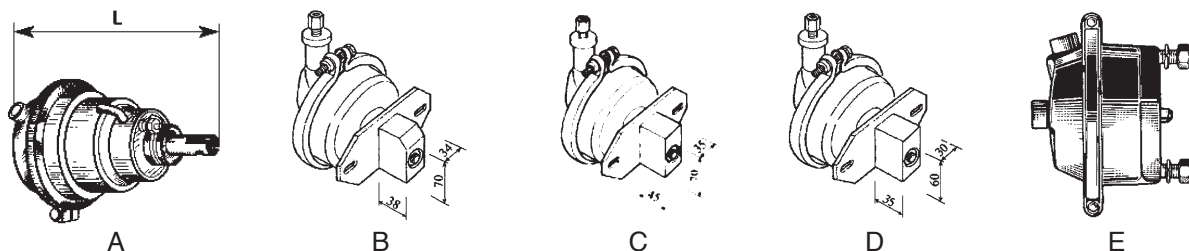

**1 CILINDRI FRENO PER FRENI A TAMBURO
BRAKE CHAMBERS AND SPRING BRAKE ACTUATORS FOR BRAKE DRUMS**

A	718267	Cilindro freno / Brake chamber Impianto frenante KNORR Brake system 1186754XU	T61 Corsa / Stroke 40 mm	IVECO	98403527	4842679
A	718266	Cilindro freno / Brake chamber Impianto frenante KNORR Brake system 1186753XU	T51 Corsa / Stroke 40 mm	IVECO	98403526	1186753 4842678

**2 CILINDRI BLOCCAGGIO PER ASSALI STERZANTI
STEERING AXLES DIAPHRAGM LOCKING CYLINDERS**

B	718090	Cilindro bloccaggio sterzante / Steering locking cylinder 34x70x38 - M12x1,5 Impianto frenante MERITOR Brake system	9" Corsa / Stroke 35 mm	MERITOR - ROR AUSTERAS		21212472 C4232520 99361002
C	718197	Cilindro bloccaggio sterzante / Steering locking cylinder 35x70x45 - M16x1,5 Impianto frenante MERITOR Brake system	9" Corsa / Stroke 35 mm	MERITOR - ROR		21223339 C4232511
D	718198	Cilindro bloccaggio sterzante / Steering locking cylinder 30x60x35 - M12x1,5 Impianto frenante MERITOR Brake system	9" Corsa / Stroke 35 mm	MERITOR - ROR		C4232502

**3 CILINDRI FRENO PER FRENI A DISCO
BRAKE CHAMBERS AND BRAKE ACTUATORS FOR BRAKE DISCS**

E	718281	Cilindro freno / Brake chamber Impianto frenante KNORR Brake system BS3260	14" Corsa / Stroke 57 mm	DAF RENAULT MERITOR - ROR Assale serie LM-LC Axles parts Disco freno ELSA 2 Brake disc	1489884 5021200537 41227562	1489885 5021200538 41227563
E	718191	Cilindro freno / Brake chamber Impianto frenante KNORR Brake system BS3300	16" Corsa / Stroke 57 mm	DAF MERCEDES SCANIA BPW SAF		1505241 0064205224 1932621 0203277000 0544432010 0203277100 0544432020 4454106560 3454106560 3454108160
E	718192	Cilindro freno / Brake chamber Impianto frenante KNORR Brake system BS3404	20" Corsa / Stroke 64 mm	DAF MAN MERCEDES SCANIA BPW SAF		1517954 N2504016063 0074201224 1932639 0203277400 0203277500 3454106760 3454108260
E	718193	Cilindro freno / Brake chamber Impianto frenante KNORR Brake system BS3509	24" Corsa / Stroke 64 mm	DAF IVECO MERCEDES SCANIA BPW SAF		1517956 500590336 0074201424 1932640 0203277800 0203277900 3454106960

I marchi ed i nominativi dei costruttori come pure i riferimenti originali sono esposti a solo titolo indicativo in quanto i nostri particolari non sono originali
Manufacturer's names and part numbers in this catalogue are used for cross reference purposes only and do not imply anything about the origin or manufacturer of product.

FIG. ITEM	RIF. ERREVI ERREVI REF.	DESCRIZIONE PARTICOLARI DESCRIPTION	TIPO VEHICLE MODEL	RIF. ORIGINALE ORIGINAL REF.	
IMPIANTI FRENO / AIR BRAKE PARTS					
 A					
1 CILINDRI FRENO PER FRENI A DISCO BRAKE CHAMBERS AND BRAKE ACTUATORS FOR BRAKE DISCS					
A	718268	Cilindro freno attuatore Dx / <i>Brake actuator RH</i> Impianto frenante MERITOR Brake system	14 / 24" Corsa / Stroke 76 mm	MERITOR - ROR Assale serie LM-LC e TA-TC Axles parts Disco freno ELSA 2 Brake disc MAN RENAULT	41227567 41231074 N2504016051 7424990227
A	718285	Cilindro freno attuatore Sx / <i>Brake actuator LH</i> Impianto frenante MERITOR Brake system	14 / 24" Corsa / Stroke 76 mm	MERITOR - ROR Assale serie LM-LC e TA-TC Axles parts Disco freno ELSA 2 Brake disc MAN RENAULT	41227566 41231073 N2504016050 7424990226
A	718287	Cilindro freno attuatore Dx / <i>Brake actuator RH</i> Impianto frenante MERITOR Brake system	18 / 24" Corsa / Stroke 76 mm	MERITOR - ROR Assale serie LM-LC e TA-TC Axles parts Disco freno ELSA 2 Brake disc MAN RENAULT	41227570 41231081 N2504016066 7424990230
A	718269	Cilindro freno attuatore Sx / <i>Brake actuator LH</i> Impianto frenante MERITOR Brake system	18 / 24" Corsa / Stroke 76 mm	MERITOR - ROR Assale serie LM-LC e TA-TC Axles parts Disco freno ELSA 2 Brake disc MAN RENAULT	41227571 41231082 N2504016065 7424990231
A	718272	Cilindro freno attuatore Dx / <i>Brake actuator RH</i> Impianto frenante MERITOR Brake system	18 / 24" Corsa / Stroke 64 mm	MERITOR - ROR Assale serie LM-LC Axles parts Disco freno ELSA 195 Brake disc Assale serie TA-TC Axles parts Disco freno D DUCO Brake disc	41226807 41229062 41231594
A	718286	Cilindro freno attuatore Sx / <i>Brake actuator LH</i> Impianto frenante MERITOR Brake system	18 / 24" Corsa / Stroke 64 mm	MERITOR - ROR Assale serie LM-LC Axles parts Disco freno ELSA 195 Brake disc Assale serie TA-TC Axles parts Disco freno D DUCO Brake disc	41226806 41229063 41231595
A	718288	Cilindro freno attuatore Dx / <i>Brake actuator RH</i> Impianto frenante MERITOR Brake system	20 / 24" Corsa / Stroke 64 mm	MERITOR - ROR Assale serie LM-LC Axles parts Disco freno ELSA 195 Brake disc Assale serie TA-TC Axles parts Disco freno D DUCO Brake disc	41229067 41226811
A	718270	Cilindro freno attuatore Sx / <i>Brake actuator LH</i> Impianto frenante MERITOR Brake system	20 / 24" Corsa / Stroke 64 mm	MERITOR - ROR Assale serie LM-LC Axles parts Disco freno ELSA 195 Brake disc Assale serie TA-TC Axles parts Disco freno D DUCO Brake disc	41226810 41229066
A	718311	Cilindro freno attuatore Dx / <i>Brake actuator RH</i> Impianto frenante MERITOR Brake system	20 / 24" Corsa / Stroke 76 mm	MERITOR - ROR Assale serie LM-LC e TA-TC Axles parts Disco freno ELSA 2 Brake disc RENAULT	41227572 41231085 7424490232
A	718310	Cilindro freno attuatore Sx / <i>Brake actuator LH</i> Impianto frenante MERITOR Brake system	20 / 24" Corsa / Stroke 76 mm	MERITOR - ROR Assale serie LM-LC e TA-TC Axles parts Disco freno ELSA 2 Brake disc RENAULT	41227573 41231086 7424490233

I marchi ed i nominativi dei costruttori come pure i riferimenti originali sono esposti a solo titolo indicativo in quanto i nostri particolari non sono originali
 Manufacturer's names and part numbers in this catalogue are used for cross reference purposes only and do not imply anything about the origin or manufacturer of product.

FIG. ITEM	RIF. ERREVI ERREVI REF.	DESCRIZIONE PARTICOLARI DESCRIPTION	TIPO VEHICLE MODEL	RIF. ORIGINALE ORIGINAL REF.
-----------	-------------------------	-------------------------------------	--------------------	------------------------------

IMPIANTI FRENO / AIR BRAKE PARTS

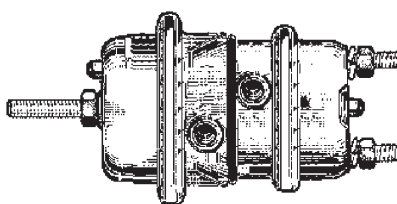

A

**1 segue CILINDRI FRENO PER FRENI A DISCO
cont'd BRAKE CHAMBERS AND BRAKE ACTUATORS FOR BRAKE DISCS**

A	718313	Cilindro freno attuatore Dx / Brake actuator RH Impianto frenante MERITOR Brake system	22 / 24" Corsa / Stroke 76 mm	MERITOR - ROR Assale serie LM-LC e TA-TC Axles parts Disco freno ELSA 2 Brake disc RENAULT	41227574	41231087 7424490234
A	718312	Cilindro freno attuatore Sx / Brake actuator LH Impianto frenante MERITOR Brake System	22 / 24" Corsa / Stroke 76 mm	MERITOR - ROR Assale serie LM-LC e TA-TC Axles parts Disco freno ELSA 2 Brake disc RENAULT	41227575	41231088 7424490235
A	718289	Cilindro freno attuatore Dx / Brake actuator RH Impianto frenante MERITOR Brake system	24 / 24" Corsa / Stroke 64 mm	MERITOR - ROR Assale serie LM-LC Axles parts Disco freno ELSA 195 Brake disc Assale serie TA-TC Axles parts Disco freno D DUCO Brake disc	41229074	41229271
A	718271	Cilindro freno attuatore Sx / Brake actuator LH Impianto frenante MERITOR Brake system	24 / 24" Corsa / Stroke 64 mm	MERITOR - ROR Assale serie LM-LC Axles parts Disco freno ELSA 195 Brake disc Assale serie TA-TC Axles parts Disco freno D DUCO Brake disc	41229075	41229272 41231607
A	718315	Cilindro freno attuatore Dx / Brake actuator RH Impianto frenante MERITOR Brake system	24 / 24" Corsa / Stroke 76 mm	MERITOR - ROR Assale serie LM-LC e TA-TC Axles parts Disco freno ELSA 2 Brake disc RENAULT	41227867	41231089 7424490236
A	718314	Cilindro freno attuatore Sx / Brake actuator LH Impianto frenante MERITOR Brake system	24 / 24" Corsa / Stroke 76 mm	MERITOR - ROR Assale serie LM-LC e TA-TC Axles parts Disco freno ELSA 2 Brake disc RENAULT	41227868	41231090 7424490237

**2 CILINDRI FRENO PER FRENI A DISCO
BRAKE CHAMBERS AND BRAKE ACTUATORS FOR BRAKE DISCS**

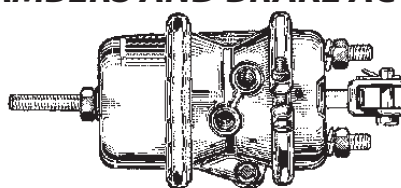

A

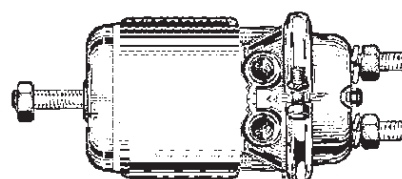

B

A	718291	Cilindro freno attuatore Dx / Brake actuator RH Impianto frenante MERITOR Brake system	16 / 24" Corsa / Stroke 76 mm	MERITOR - ROR Assale serie LM-LC e TA-TC Axle series Disco freno ELSA 2 Brake disc MAN	41227569	41231078 N2504016053
A	718292	Cilindro freno attuatore Sx / Brake actuator LH Impianto frenante MERITOR Brake system	16 / 24" Corsa / Stroke 76 mm	MERITOR - ROR Assale serie LM-LC e TA-TC Axle series Disco freno ELSA 2 Brake disc RENAULT	41227568	41231077 7424990228
A	718264	Cilindro freno attuatore / Brake actuator Impianto frenante MERITOR Brake system	20 / 24" Corsa / Stroke 64 mm	MERITOR - ROR Assale serie TM e LM-LC Axles parts Disco freno DX 195 Brake disc MAN RENAULT	41224965	41225765 41231055 N2504016043 7424990223

I marchi ed i nominativi dei costruttori come pure i riferimenti originali sono esposti a solo titolo indicativo in quanto i nostri particolari non sono originali
Manufacturer's names and part numbers in this catalogue are used for cross reference purposes only and do not imply anything about the origin or manufacturer of product.

FIG. ITEM	RIF. ERREVI ERREVI REF.	DESCRIZIONE PARTICOLARI DESCRIPTION	TIPO VEHICLE MODEL	RIF. ORIGINALE ORIGINAL REF.	
IMPIANTI FRENO / AIR BRAKE PARTS					
		 A	 B		
1 segue CILINDRI FRENO PER FRENI A DISCO cont'd BRAKE CHAMBERS AND BRAKE ACTUATORS FOR BRAKE DISCS					
A	718293	Cilindro freno attuatore Dx / <i>Brake actuator RH</i> Impianto frenante MERITOR Brake system	22 / 24" Corsa / Stroke 64 mm	MERITOR - ROR Assale serie LM-LC e TA-TC Axle series Disco freno ELSA 2 Brake disc	41229071 41229268
A	718294	Cilindro freno attuatore Sx / <i>Brake actuator LH</i> Impianto frenante MERITOR Brake system	22 / 24" Corsa / Stroke 64 mm	MERITOR - ROR Assale serie LM-LC e TA-TC Axle series Disco freno ELSA 2 Brake disc	41229070 41229267
A	718265	Cilindro freno attuatore / <i>Brake actuator</i> Impianto frenante MERITOR Brake system	24 / 24" Corsa / Stroke 64 mm	MERITOR - ROR Assale serie TM e LM-LC Axles parts Disco freno DX 195 Brake disc DAF MAN RENAULT	41225080 41225763 41231059 0905514 1489043 N2504016042 7424990221
B	718254	Cilindro freno attuatore / <i>Brake actuator</i> Impianto frenante WABCO Brake system 9254860100	12 / 24" Corsa / Stroke 57 mm	MERCEDES	0154205518 0204203118
B	718253	Cilindro freno attuatore / <i>Brake actuator</i> Impianto frenante WABCO Brake system 9254644500	16 / 16" Corsa / Stroke 57 mm	DAF MERCEDES BPW	0865611 1505447 0174208818 0203278600
B	718257	Cilindro freno attuatore / <i>Brake actuator</i> Impianto frenante WABCO Brake system 9254840000 - 9254840100	16 / 24" Corsa / Stroke 64 mm	DAF MERCEDES SCANIA	1501927 1505446 0154203318 0194205318 0154204118 0194206318 1935463
B	718258	Cilindro freno attuatore / <i>Brake actuator</i> Impianto frenante WABCO Brake system 9254800000 - 9254800020	20 / 24" Corsa / Stroke 64 mm	DAF MERCEDES	1505439 1519442 0154204318 0194205518 0154204718 0194206518
B	718259	Cilindro freno attuatore / <i>Brake actuator</i> Impianto frenante WABCO Brake system 9254811500 - 9254610300	24 / 24" Corsa / Stroke 64 mm	DAF	1360929 1686001
B	718255	Cilindro freno attuatore / <i>Brake actuator</i> Impianto frenante WABCO-KNORR Brake system 9254810100 - 9254810120 - BS8517	24 / 24" Corsa / Stroke 64 mm	DAF MERCEDES	1505443 1519378 0154209318 0194205718 0154209718 0194206718
B	718256	Cilindro freno attuatore / <i>Brake actuator</i> Impianto frenante WABCO Brake system 9254813100	24 / 30" Corsa / Stroke 64 mm	SCANIA	1912988

FIG. ITEM	RIF. ERREVI ERREVI REF.	DESCRIZIONE PARTICOLARI DESCRIPTION	TIPO VEHICLE MODEL	RIF. ORIGINALE ORIGINAL REF.
-----------	-------------------------	-------------------------------------	--------------------	------------------------------

IMPIANTI FRENO / AIR BRAKE PARTS

A

B

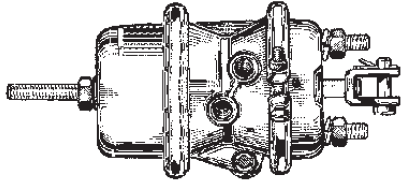
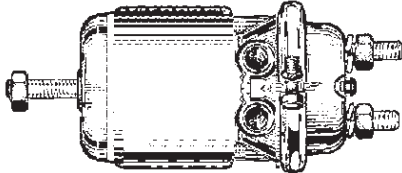
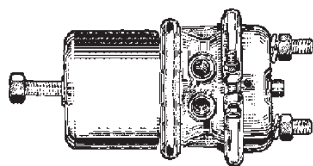
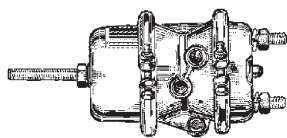
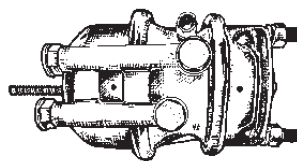
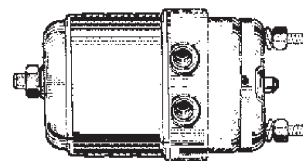
C

D

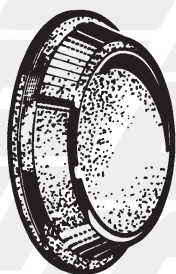
1 CILINDRI FRENO PER FRENI A DISCO BRAKE CHAMBERS AND BRAKE ACTUATORS FOR BRAKE DISCS

A	718250	Cilindro freno attuatore / <i>Brake actuator</i> Impianto frenante KNORR-HALDEX <i>Brake system</i> BS9510 - II33679000	24 / 14" Corsa / Stroke 50 mm	SCANIA	1383090 1485834	1734994 1802664
A	718251	Cilindro freno attuatore / <i>Brake actuator</i> Impianto frenante KNORR-HALDEX <i>Brake system</i> BS9520 - II34388	24 / 24" Corsa / Stroke 60 mm	SCANIA		-
A	718252	Cilindro freno attuatore / <i>Brake actuator</i> Impianto frenante WABCO-KNORR <i>Brake system</i> BS8500 - K017119N00 - 9254813120	24 / 30" Corsa / Stroke 60 mm	SCANIA VOLVO	1390369 1427474 1734995	1802658 1916992 2147779 20524534
B	718194	Cilindro freno attuatore / <i>Brake actuator</i> Impianto frenante KNORR-HALDEX <i>Brake system</i> BS7309 - 1351624004	16 / 24" Corsa / Stroke 64 mm	BPW SAF		0544440010 4454107730
B	718282	Cilindro freno attuatore / <i>Brake actuator</i> Impianto frenante HALDEX <i>Brake system</i> 346186001	18 / 24" Corsa / Stroke 64 mm	BPW	0544442010	0544442020
B	718199	Cilindro freno attuatore / <i>Brake actuator</i> Impianto frenante HALDEX <i>Brake system</i> 1352024003	20 / 24" Corsa / Stroke 64 mm	SCHMITZ		-
C	718200	Cilindro freni attuatore con prolunghe <i>Brake actuator c/w pipes</i> Impianto frenante KNORR-HALDEX <i>Brake system</i> BS7309 - 1351624004	16 / 24" Corsa / Stroke 64 mm	SAF		4454107764
D	718284	Cilindro freno DX / <i>Brake chamber RH</i> Impianto frenante KNORR-HALDEX <i>Brake system</i> BT5800-BS9421-K009970-II34000	20 / 27" Corsa / Stroke 64 mm	IVECO	99474409	41285072
D	718283	Cilindro freno SX / <i>Brake chamber LH</i> Impianto frenante KNORR-HALDEX <i>Brake system</i> BT5801-BS9424-K009971-II34185	20 / 27" Corsa / Stroke 64 mm	IVECO	99482723	41285073

IMPIANTI FRENO / AIR BRAKE PARTS



- 1 - 731950 9"
- 2 - 731951 12"
- 3 - 731952 16"
- 4 - 731953 20"
- 5 - 731964 22"
- 6 - 731954 24"
- 7 - 731955 30"

TIPO BASSO



- 8 - 731963 12"

TIPO MEDIO



- 9 - 731962 9"
- 10 - 731961 12"
- 11 - 731957 16"
- 12 - 731958 20"
- 13 - 731959 24"
- 14 - 731960 30"

TIPO ALTO

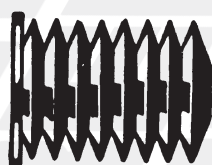

730541
15

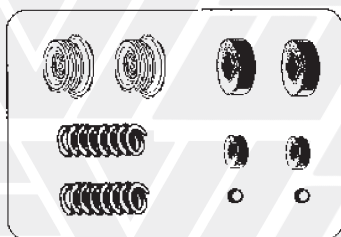

718103
16

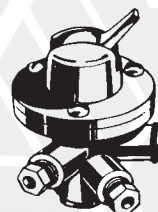

718112
17

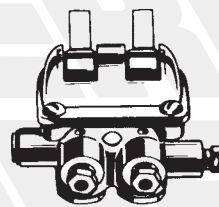

718113
18

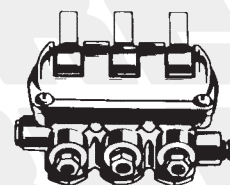

718114
19



730518
20

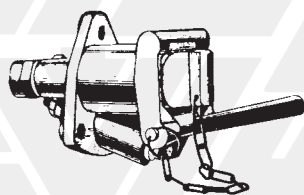

- 21 - 718101 con sfere / (with sphere)
- 22 - 718100 con puntalini / (with stem)



718110
23



718111
24

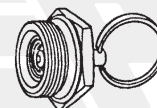

718195
25

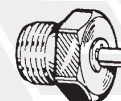

718196
26

FIG. ITEM	RIF. ERREVI ERREVI REF.	DESCRIZIONE PARTICOLARI DESCRIPTION	TIPO VEHICLE MODEL		RIF. ORIGINALE ORIGINAL REF.
IMPIANTI FRENO / AIR BRAKE PARTS					
1	731950	Membrana per Brake Chamber Normale Bassa / <i>Diaphragm-Standard</i>	9"		8971204924
2	731951	Membrana per Brake Chamber Normale Bassa / <i>Diaphragm-Standard</i>	12"		-
3	731952	Membrana per Brake Chamber Normale Bassa / <i>Diaphragm-Standard</i>	16"		8971205104
4	731953	Membrana per Brake Chamber Normale Bassa / <i>Diaphragm-Standard</i>	20"		8971205204
5	731964	Membrana per Brake Chamber Normale Bassa / <i>Diaphragm-Standard</i>	22"		-
6	731954	Membrana per Brake Chamber Normale Bassa / <i>Diaphragm-Standard</i>	24"		8971205304
7	731955	Membrana per Brake Chamber Normale Bassa / <i>Diaphragm-Standard</i>	30"		8971205404
8	731963	Membrana per Brake Chamber Tipo Medio / <i>Diaphragm-Standard</i>	12"		8971205054
9	731962	Membrana per Brake Chamber Tipo Alto / <i>Diaphragm-Standard</i>	9"		-
10	731961	Membrana per Brake Chamber Tipo Alto / <i>Diaphragm-Standard</i>	12"		-
11	731957	Membrana per Brake Chamber Tipo Alto / <i>Diaphragm-Standard</i>	16"		8971205164
12	731958	Membrana per Brake Chamber Tipo Alto / <i>Diaphragm-Standard</i>	20"		8971205264
13	731959	Membrana per Brake Chamber Tipo Alto / <i>Diaphragm-Standard</i>	24"		8971205364
14	731960	Membrana per Brake Chamber Tipo Alto / <i>Diaphragm-Standard</i>	30"		8971205464
15	730541	Parapolvere per cilindro freni / <i>Dustcover boot</i>	ø 125	U.T. Marelli	-
16	718103	Kit revisione valvola semiaccoppiamento (con sfere) <i>Repair kit for coupling with spheres</i>			-
17	718112	Deviatore pneumatico a 1 via / <i>One-way switch</i>			-
18	718113	Deviatore pneumatico a 2 vie / <i>Two-ways switch</i>			-
19	718114	Deviatore pneumatico a 3 vie / <i>Three-ways switch</i>			-
20	730518	Guarnizione in gomma per semiaccoppiamento / <i>Air coupling seal</i>			-
21	718101	Valvola semiaccoppiamento fissa F22/F22 con sfere <i>Semi-coupling with sphere</i>			-
22	718100	Valvola semiaccoppiamento fissa F22/F22 con puntalini <i>Semi-coupling with stem</i>		Semirimorchi / <i>Semitrailers</i>	AC 425 A
23	718110	Valvola semiaccoppiamento mobile con puntalini <i>Semi-coupling with stem</i>		Rimorchi / <i>Trailers</i>	AC 450 A
24	718111	Valvola semiaccoppiamento mobile con sfere / <i>Semi-coupling with sphere</i>		Semirimorchi / <i>Semitrailers</i>	AC 465 A
25	718195	Valvola manuale di spurgo condensa / <i>Drain valve</i>			2486790 4672326
26	718196	Valvola automatica di spurgo condensa / <i>Drain valve</i>			4745905 4755126

1 SEMIGIUNTI ACCOPPIAMENTO / AIR COUPLINGS



730855
1

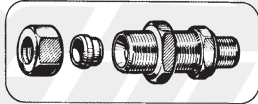

731280
2

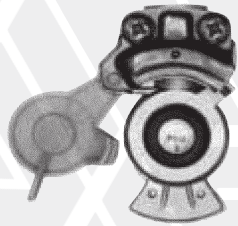

3 - 718171

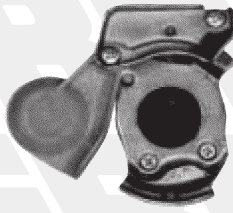

4 - 718173

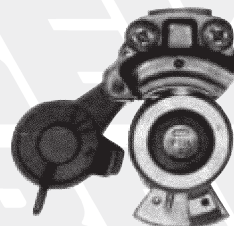

5 - 718172

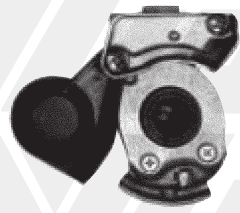

6 - 718174

2 TUBI DI COLLEGAMENTO PNEUMATICI / AIR COILS

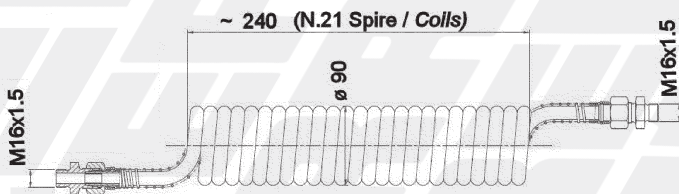

~ 240 (N.21 Spire / Coils)
7 - 711800 ROSSO/RED
8 - 711801 BLU/BLUE
9 - 711802 GIALLO/YELLOW

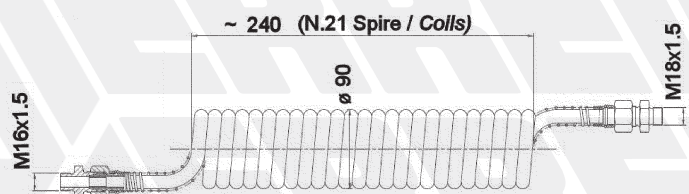

~ 240 (N.21 Spire / Coils)
10 - 711804 NERO/BLACK

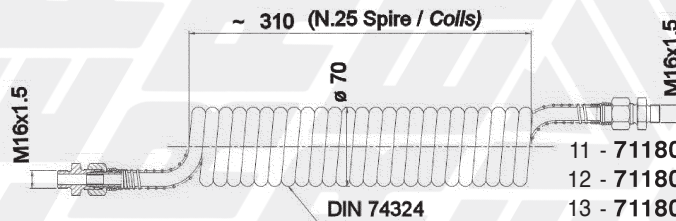

~ 310 (N.25 Spire / Coils)
11 - 711805 ROSSO/RED
12 - 711806 GIALLO/YELLOW
13 - 711807 NERO/BLACK
DIN 74324

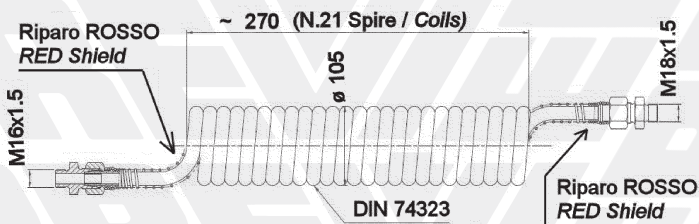

~ 270 (N.21 Spire / Coils)
14 - 711808 NERO con RIPARI ROSSI/BLACK with RED SHIELDS
DIN 74323

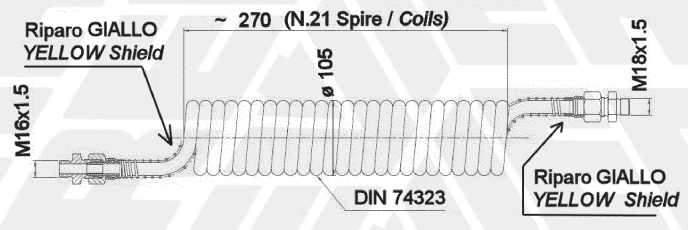

~ 270 (N.21 Spire / Coils)
15 - 711809 NERO con RIPARI GIALLI/BLACK with YELLOW SHIELDS
DIN 74323

FIG. ITEM	RIF. ERREVI ERREVI REF.	DESCRIZIONE PARTICOLARI DESCRIPTION	TIPO VEHICLE MODEL	RIF. ORIGINALE ORIGINAL REF.
<div style="text-align: center;"> <h1>1 SEMIGIUNTI ACCOPPIAMENTO AIR COUPLINGS</h1> </div>				
1	730855	Guarnizione per valvola semiaccoppiamento / <i>Palm coupling seal</i>		-
2	731280	Raccordo diritto attraversamento parete / <i>Palm coupling connection</i>		-
3	718171	Semigiunto accopp. - GIALLO - s/valvola/ <i>Palm coupling w/o valve (yellow dust cover)</i>		-
4	718173	Semigiunto accopp. - GIALLO - c/valvola <i>Palm coupling c/w valve (yellow dust cover)</i>		-
5	718172	Semigiunto accopp. - ROSSO - s/valvola <i>Palm coupling w/o valve (red dust cover)</i>		-
6	718174	Semigiunto accopp. - ROSSO - c/valvola <i>Palm coupling c/w valve (red dust cover)</i>		-
<div style="text-align: center;"> <h1>2 TUBI DI COLLEGAMENTO PNEUMATICI AIR COILS</h1> </div>				
7	711800	Tubo a spirale impianto aria - 21 Spire <i>Air coil - 21 Coils</i> Tipo ROSSO / RED type	Ø est. / O.D. 90 mm 170/190NT26 - 170NT35 180NT - 300PT - 170/190.35T 190i26T/.i35T - 190.30T/.38T DAF - MAN - MERCEDES SCANIA - VOLVO	4633471
8	711801	Tubo a spirale impianto aria - 21 Spire <i>Air coil - 21 Coils</i> Tipo BLU / BLUE type	Ø est. / O.D. 90 mm 170/190NT26 - 170NT35 180NT - 300PT - 170/190.35T 190i26T/i35T - 190.30T/.38T DAF - MAN - MERCEDES SCANIA - VOLVO	4633472
9	711802	Tubo a spirale impianto aria - 21 Spire <i>Air coil - 21 Coils</i> Tipo GIALLO / YELLOW type	Ø est. / O.D. 90 mm 190.30T/.38T DAF - MAN - MERCEDES SCANIA - VOLVO	4644217
10	711804	Tubo a spirale impianto aria - 21 Spire <i>Air coil - 21 Coils</i> Tipo NERO / BLACK type	Ø est. / O.D. 90 mm 175.24T - 190.30T/.38T - 260.36 190.33T/.36T/.42T/.48T - 260.48T 330.26HT/.30HT/.35HT/.36HT MERCEDES	41800543
11	711805	Tubo a spirale impianto aria in POLIURETANO (DIN 74324) - 25 Spire <i>Air coil - POLYURETHAN Type (DIN 74324) - 25 Coils</i> Tipo ROSSO / RED type	Ø est. / O.D. 70 mm	-
12	711806	Tubo a spirale impianto aria in POLIURETANO (DIN 74324) - 25 Spire <i>Air coil - POLYURETHAN Type (DIN 74324) - 25 Coils</i> Tipo GIALLO / YELLOW type	Ø est. / O.D. 70 mm	-
13	711807	Tubo a spirale impianto aria in POLIURETANO (DIN 74324) - 25 Spire <i>Air coil - POLYURETHAN Type (DIN 74324) - 25 Coils</i> Tipo NERO / BLACK type	Ø est. / O.D. 70 mm	-
14	711808	Tubo a spirale impianto aria in POLIURETANO (DIN 74323) - 21 Spire <i>Air coil - POLYURETHAN Type (DIN 74323) - 21 Coils</i> Con riparo ROSSO / with RED shield	Ø est. / O.D. 105 mm EUROTECH-EUROSTAR EUROTECH "CURSOR" EUROSTAR "CURSOR" EUROTRAKKER - STRALIS EUROTRAKKER "CURSOR"	41211250 42545899
15	711809	Tubo a spirale impianto aria in POLIURETANO (DIN 74323) - 21 Spire <i>Air coil - POLYURETHAN Type (DIN 74323) - 21 Coils</i> Con riparo GIALLO / with YELLOW shield	Ø est. 105 mm O.D. 105 mm EUROTECH-EUROSTAR EUROTECH "CURSOR" EUROSTAR "CURSOR" EUROTRAKKER - STRALIS EUROTRAKKER "CURSOR"	41211251 42545898

1 COLLEGAMENTI ELETTRICI ELECTRICAL COILS PLUGS AND SOCKETS



718415
1



2 - 718400
3 - 718416
4 - 718407
5 - 718408
6 - 718409
7 - 718410

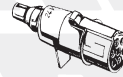

8 - 718405
9 - 718401
10 - 718406
11 - 718402
12 - 718403
13 - 718404

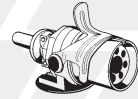

14 - 718411
15 - 718412
16 - 718413
17 - 718414

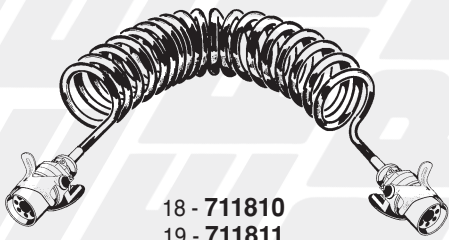

18 - 711810
19 - 711811
20 - 711812



21 - 711814
22 - 711815
23 - 711803

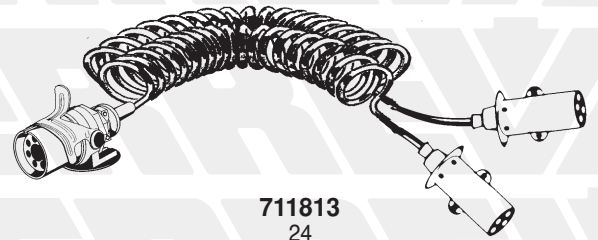

711813
24

2 TUBI FLESSIBILI ARIA / AIR FLEXIBLE TUBES



25 - 711598 mm. 700
26 - 711599 mm. 800
27 - 711600 mm. 900

3 VARIE / MISCELLANEOUS

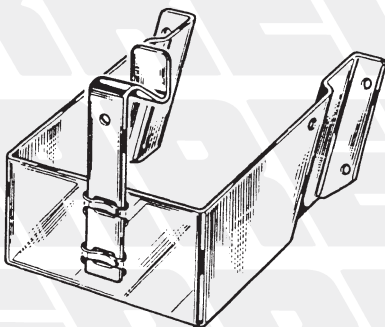

793031
30

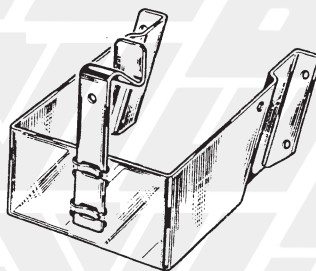

793030
31

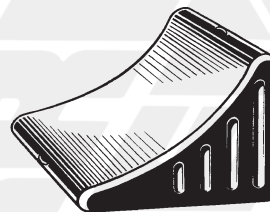

793020
28



793021
29





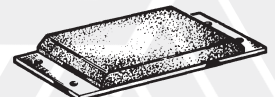

732340
32



760103
33

FIG. ITEM	RIF. ERREVI ERREVI REF.	DESCRIZIONE PARTICOLARI DESCRIPTION	TIPO VEHICLE MODEL	RIF. ORIGINALE ORIGINAL REF.
1 COLLEGAMENTI ELETTRICI ELECTRICAL COILS PLUGS AND SOCKETS				
1	718415	Adattatore a 15 poli - 24 V - tipo N / S / 15 Core adapter - 24 V - N / S types	ISO 12098	-
2	718400	Presa a 7 poli - 24 V - in alluminio - attacchi lamellari - tipo N 7 Pin socket - 24 V aluminium - flat terminals - N type	ISO 1185 DIN 72579	-
3	718416	Presa a 7 poli - 24 V - in alluminio - attacchi filettati - tipo N 7 Pin socket - 24 V aluminium - screw terminals - N type	ISO 1185 DIN 72579	-
4	718407	Presa a 7 poli - 24 V - per EBS / 7 Pin EBS socket - 24 V	ISO 7638	-
5	718408	Presa a 7 poli - 24 V - per EBS - attacchi filettati 7 Pin EBS socket - 24 V - screw terminals	ISO 7638	-
6	718409	Presa a 15 poli - 24 V / 15 Pin socket - 24 V	ISO 12098	-
7	718410	Presa a 15 poli - 24 V - attacchi filettati 15 Pin socket - 24 V - screw terminals	ISO 12098	-
8	718405	Spina a 7 poli - 24 V - in alluminio - attacchi filettati - tipo N 7 Pin plug - 24 V aluminium - screw terminals - N type	ISO 1185 DIN 72579	-
9	718401	Spina a 7 poli - 24 V - in alluminio - attacchi lamellari - tipo N 7 Pin plug - 24 V aluminium - flat terminals - N type	ISO 1185 DIN 72579	-
10	718406	Spina a 7 poli - 24 V - in alluminio - attacchi filettati - tipo S 7 Pin plug - 24 V aluminium - screw terminals - S type	ISO 3731	-
11	718402	Spina a 7 poli - 24 V - in termoplastica - attacchi filettati - tipo N 7 Pin plug - 24 V thermoplastic - screw terminals - N type	ISO 1185 DIN 72579	-
12	718403	Spina a 7 poli - 24 V - in termoplastica - attacchi filettati - tipo S 7 Pin plug - 24 V thermoplastic - screw terminals - S type	ISO 3731	-
13	718404	Spina a 7 poli - 24 V - in termoplastica VERDE - attacchi filettati - tipo S 7 Pin plug - 24 V GREEN thermoplastic - screw terminals - S type	ISO 3731	-
14	718411	Spina a 7 poli - 24 V - per EBS (con anti-arrotolamento) 7 Pin EBS plug - 24 V - with anti-kink bush for cable	ISO 7638	-
15	718412	Spina a 7 poli - 24 V - per EBS (con anti-arrotolamento) - attacchi filettati 7 Pin EBS plug - 24 V - with anti-kink bush for cable - screw terminals	ISO 7638	-
16	718413	Spina a 15 poli - 24 V - (con anti-arrotolamento) 15 Pin plug - 24 V - with anti-kink bush for cable	ISO 12098	-
17	718414	Spina a 15 poli - 24 V - (con anti-arrotolamento) - attacchi filettati 15 Pin plug - 24 V - with anti-kink bush for cable - screw terminals	ISO 12098	-
18	711810	Tubo a spirale impianto elettrico con spine a 5 Poli per ABS ABS Electrical cable with ABS (5 Pole) plugs	L= 4 mt. ISO 7638	-
19	711811	Tubo a spirale impianto elettrico con spine a 7 Poli per EBS EBS Electrical cable with EBS (7 Pole) plugs	L= 4 mt. ISO 7638	-
20	711812	Tubo a spirale impianto elettrico con spine a 15 Poli 15 Pole Electrical cable with 15 Pole plugs	L= 3 mt. ISO 7638	-
21	711814	Tubo a spirale impianto elettrico con spine a 7 Poli - tipo N 7 Pole electrical cable with N type 24 V. plugs	L= 3,5 mt. ISO 1185	-
22	711815	Tubo a spirale impianto elettrico con spine a 7 Poli - tipo S 7 Pole electrical cable with S type 24 V. plugs	L= 3,5 mt. ISO 1185	-
23	711803	Tubo a spirale impianto elettrico - con spine a 7 Poli in alluminio - tipo N Trailer electrical cable with 7 Pole plugs - N type	ISO 1185 ISO 3731	4634846
24	711813	Tubo a spirale impianto elettrico - con spina a 15 Poli e 7 Poli - tipo N/S Trailer 15 Pole adapter cable	L=3,5 mt. ISO 1185-3731 12098	-
2 TUBI FLESSIBILI ARIA AIR FLEXIBLE TUBES				
25	711598	Tubo flessibile per freni maschio/maschio / <i>Air flexible tube</i>	M22x1,5 L=700	-
26	711599	Tubo flessibile per freni maschio/maschio / <i>Air flexible tube</i>	M22x1,5 L=800	-
27	711600	Tubo flessibile per freni maschio/maschio / <i>Air flexible tube</i>	M22x1,5 L=900	-
3 VARIE / MISCELLANEOUS				
28	793020	Calzatoia ruota tipo grande / <i>Wheel chock, large type</i>		-
29	793021	Calzatoia ruota tipo medio / <i>Wheel chock, medium type</i>		-
30	793031	Supporto per calzatoia tipo grande / <i>Wheel chock holder, large type</i>		-
31	793030	Supporto per calzatoia tipo medio / <i>Wheel chock holder, medium type</i>		-
32	732340	Gancio ad occhio aperto / <i>Hook</i>		-
33	760103	Tampone paracolpi per cassone / <i>Rubber pad</i>		0732401

FIG. ITEM	RIF. ERREVI ERREVI REF.	DESCRIZIONE PARTICOLARI DESCRIPTION	TIPO VEHICLE MODEL	RIF. ORIGINALE ORIGINAL REF.
RIVETTI PER CEPPI FRENO BRAKE LINING RIVETS				
1	731367	Rivetti in alluminio semiforati / Aluminium - Semi-tubular	∅ 6x15 T ∅ 12	-
2	731366	Rivetti in alluminio semiforati / Aluminium - Semi-tubular	∅ 6x18 T ∅ 12	-
3	731365	Rivetti in alluminio semiforati / Aluminium - Semi-tubular	∅ 6x20 T ∅ 12	-
4	731360	Rivetti in alluminio semiforati / Aluminium - Semi-tubular	∅ 8x18 T ∅ 16	-
5	731354	Rivetti in alluminio semiforati / Aluminium - Semi-tubular	∅ 8x20 T ∅ 13	-
6	731363	Rivetti in alluminio semiforati / Aluminium - Semi-tubular	∅ 8x20 T ∅ 16	-
7	731355	Rivetti in alluminio semiforati / Aluminium - Semi-tubular	∅ 8x23 T ∅ 13	-
8	731361	Rivetti in alluminio semiforati / Aluminium - Semi-tubular	∅ 8x23 T ∅ 16	-
9	731481	Rivetti in ottone semiforati / Brass - Semi-tubular	∅ 5x15 T ∅ 12	-
10	731482	Rivetti in ottone semiforati / Brass - Semi-tubular	∅ 5x16 T ∅ 12	-
11	731370	Rivetti in ottone semiforati / Brass - Semi-tubular	∅ 6,3x14 T ∅ 12	-
12	731451	Rivetti in ottone semiforati / Brass - Semi-tubular	∅ 6,3x16 T ∅ 12	-
13	731368	Rivetti in ottone semiforati / Brass - Semi-tubular	∅ 6,3x17,4 T ∅ 12	-
14	731450	Rivetti in ottone semiforati / Brass - Semi-tubular	∅ 6,3x18 T ∅ 12	-
15	731369	Rivetti in ottone semiforati / Brass - Semi-tubular	∅ 6,3x20 T ∅ 12	-
16	731483	Rivetti in ottone semiforati / Brass - Semi-tubular	∅ 6,6x18 T ∅ 12	-
17	731452	Rivetti in ottone tubolare / Brass - Fully tubular	∅ 8x20 T ∅ 16	-
18	731493	Rivetti in ottone tubolare / Brass - Fully tubular	∅ 8x16 T ∅ 15,5	-
19	731494	Rivetti in ottone tubolare / Brass - Fully tubular	∅ 8x18 T ∅ 15,5	-
20	731495	Rivetti in ottone tubolare / Brass - Fully tubular	∅ 8x20 T ∅ 15,5	-
21	731454	Rivetti in ottone tubolare / Brass - Fully tubular	∅ 8x23 T ∅ 16	-
22	731456	Rivetti in rame tubolare / Copper - Fully tubular	∅ 10x18 T ∅ 18	-
23	731458	Rivetti in rame semiforati / Copper - Semi-tubular	∅ 6,3x19 T ∅ 12	-
24	731471	Rivetti in ferro tubolare / Iron - Fully tubular	∅ 8x22 T ∅ 13,5	-
25	731472	Rivetti in ferro tubolare / Iron - Fully tubular	∅ 6,3x17,5 T ∅ 12	-
26	731384	Rivetti in ferro tubolare / Iron - Fully tubular	∅ 6,3x20 T ∅ 12	-
27	731473	Rivetti in ferro tubolare / Iron - Fully tubular	∅ 6,3x14,5 T ∅ 12 (doppio foro)	-
28	731474	Rivetti in ferro tubolare / Iron - Fully tubular	∅ 8x16 T ∅ 15,5	-
29	731475	Rivetti in ferro tubolare / Iron - Fully tubular	∅ 8x18 T ∅ 15,5	-
30	731476	Rivetti in ferro tubolare / Iron - Fully tubular	∅ 8x20 T ∅ 15,5	-
31	731477	Rivetti in ferro tubolare / Iron - Fully tubular	∅ 8x22 T ∅ 15,5	-
32	731500	Rivetti in ferro semiforati / Iron - Semi-tubular	∅ 6,6x18 T ∅ 12	-

FIG. ITEM	RIF. ERREVI ERREVI REF.	DESCRIZIONE PARTICOLARI DESCRIPTION	TIPO VEHICLE MODEL	RIF. ORIGINALE ORIGINAL REF.
<div style="text-align: center;"> <h1>1 INGRASSATORI / GREASE FITTINGS</h1>     </div>				
1	731371	Ingrassatore diritto a punta / <i>Straight type</i>	M10x1	13407211
2	731373	Ingrassatore a 45° a punta / <i>45° Angle type</i>	M10x1	13407811
3	731374	Ingrassatore a 90° a punta / <i>90° Angle type</i>	M10x1	13408411
4	731376	Ingrassatore diritto a punta / <i>Straight type</i>	M8x1	-
5	731377	Ingrassatore a 45° a punta / <i>45° Angle type</i>	M8x1	-
6	731381	Ingrassatore diritto a punta / <i>Straight type</i>	M6x1	-
<div style="text-align: center;"> <h1>2 STAFFE VARIE / U BOLTS</h1> </div>				
7	723717	Staffa balestra Tonda con dadi / <i>U Bolt c/w nuts</i>	ø 20x90x220	-
8	723723	Staffa balestra Tonda con dadi / <i>U Bolt c/w nuts</i>	ø 20x90x280	-
9	723734	Staffa balestra Quadra con dadi / <i>U Bolt c/w nuts</i>	ø 20x100x120	-
10	723736	Staffa balestra Quadra con dadi / <i>U Bolt c/w nuts</i>	ø 20x100x130	-
11	723738	Staffa balestra Quadra con dadi / <i>U Bolt c/w nuts</i>	ø 20x100x150	-
12	723746	Staffa balestra Quadra con dadi / <i>U Bolt c/w nuts</i>	ø 20x100x230	-
13	723748	Staffa balestra Quadra con dadi / <i>U Bolt c/w nuts</i>	ø 20x100x250	-
14	723752	Staffa balestra Quadra con dadi / <i>U Bolt c/w nuts</i>	ø 20x100x280	-
15	723756	Staffa balestra Quadra con dadi / <i>U Bolt c/w nuts</i>	ø 20x100x300	-